



wwPDB EM Validation Summary Report ⓘ

Mar 8, 2026 – 08:43 AM UTC

PDB ID : 9CS3 / pdb_00009cs3
EMDB ID : EMD-45886
Title : TRiC-ADP-S2 state is a conformation when TRiC incubated in 1 mM ADP
Authors : Jin, M.; Cong, Y.
Deposited on : 2024-07-23
Resolution : 5.60 Å (reported)

This is a wwPDB EM Validation Summary Report for a publicly released PDB entry.

We welcome your comments at validation@mail.wwpdb.org

A user guide is available at

<https://www.wwpdb.org/validation/2017/EMValidationReportHelp>

with specific help available everywhere you see the ⓘ symbol.

The types of validation reports are described at

<http://www.wwpdb.org/validation/2017/FAQs#types>.

The following versions of software and data (see [references ⓘ](#)) were used in the production of this report:

EMDB validation analysis : 0.0.1.dev132
MolProbity : 4-5-2 with Phenix2.0
Percentile statistics : 20250101.v01 (using entries in the PDB archive January 1st 2025)
EM percentile statistics : 202505.v01 (Using data in the EMDB archive up until May 2025)
MapQ : 1.9.13
Ideal geometry (proteins) : Engh & Huber (2001)
Ideal geometry (DNA, RNA) : Parkinson et al. (1996)
Validation Pipeline (wwPDB-VP) : 2.49

1 Overall quality at a glance i

The following experimental techniques were used to determine the structure:
ELECTRON MICROSCOPY

The reported resolution of this entry is 5.60 Å.

Percentile scores (ranging between 0-100) for global validation metrics of the entry are shown in the following graphic. The table shows the number of entries on which the scores are based.

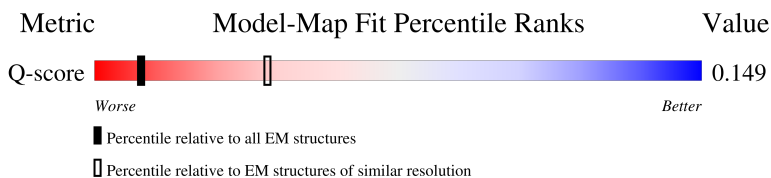
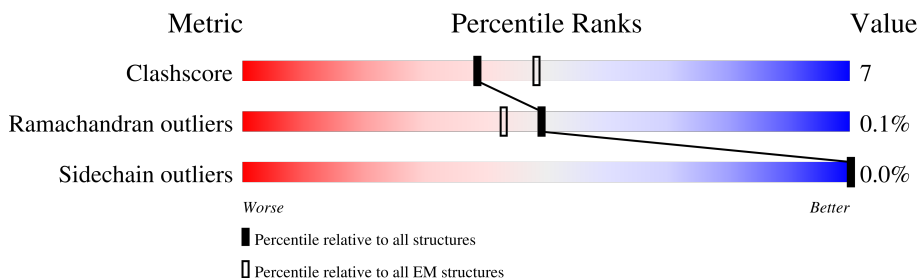



Metric	Whole archive (#Entries)	EM structures (#Entries)	Similar EM resolution (#Entries, resolution range(Å))
Clashscore	229148	23984	-
Ramachandran outliers	224038	23583	-
Sidechain outliers	223484	23102	-
Q-score	-	25397	513 (5.10 - 6.10)

The table below summarises the geometric issues observed across the polymeric chains and their fit to the map. The red, orange, yellow and green segments of the bar indicate the fraction of residues that contain outliers for ≥ 3 , 2, 1 and 0 types of geometric quality criteria respectively. A grey segment represents the fraction of residues that are not modelled. The numeric value for each fraction is indicated below the corresponding segment, with a dot representing fractions $\leq 5\%$. The upper red bar (where present) indicates the fraction of residues that have poor fit to the EM map (all-atom inclusion $< 40\%$). The numeric value is given above the bar.

Mol	Chain	Length	Quality of chain
1	A	559	<p>5% (red), 75% (green), 20% (yellow), 5% (grey)</p>
1	a	559	<p>5% (red), 77% (green), 18% (yellow), 6% (grey)</p>
2	B	527	<p>5% (red), 78% (green), 20% (yellow), 5% (grey)</p>
2	b	527	<p>5% (red), 77% (green), 19% (yellow), 5% (grey)</p>

Continued on next page...

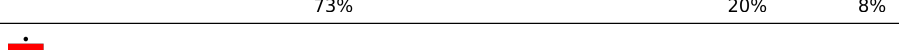
Continued from previous page...

Mol	Chain	Length	Quality of chain
3	E	562	 75% 18% 7%
3	e	562	 77% 15% 8%
4	G	594	 63% 18% 19%
4	g	594	 66% 16% 18%
5	H	550	 73% 20% 8%
5	h	550	 77% 15% 8%
6	Q	568	 74% 18% 8%
6	q	568	 74% 18% 8%
7	Z	546	 76% 17% 7%
7	z	546	 77% 17% 6%
8	D	528	 79% 20% .
8	d	528	 84% 15% .

2 Entry composition [i](#)

There are 8 unique types of molecules in this entry. The entry contains 62699 atoms, of which 0 are hydrogens and 0 are deuteriums.

In the tables below, the AltConf column contains the number of residues with at least one atom in alternate conformation and the Trace column contains the number of residues modelled with at most 2 atoms.

- Molecule 1 is a protein called T-complex protein 1 subunit alpha.

Mol	Chain	Residues	Atoms					AltConf	Trace
			Total	C	N	O	S		
1	A	529	Total	C	N	O	S	0	0
			3994	2498	695	783	18		
1	a	528	Total	C	N	O	S	0	0
			3983	2491	695	777	20		

- Molecule 2 is a protein called T-complex protein 1 subunit beta.

Mol	Chain	Residues	Atoms					AltConf	Trace
			Total	C	N	O	S		
2	B	513	Total	C	N	O	S	0	0
			3898	2434	674	776	14		
2	b	506	Total	C	N	O	S	0	0
			3838	2400	663	761	14		

- Molecule 3 is a protein called T-complex protein 1 subunit epsilon.

Mol	Chain	Residues	Atoms					AltConf	Trace
			Total	C	N	O	S		
3	E	522	Total	C	N	O	S	0	0
			4022	2525	690	786	21		
3	e	517	Total	C	N	O	S	0	0
			3974	2496	677	780	21		

- Molecule 4 is a protein called T-complex protein 1 subunit gamma.

Mol	Chain	Residues	Atoms					AltConf	Trace
			Total	C	N	O	S		
4	G	480	Total	C	N	O	S	0	0
			3673	2308	648	692	25		
4	g	487	Total	C	N	O	S	0	0
			3725	2341	655	704	25		

There are 120 discrepancies between the modelled and reference sequences:

Chain	Residue	Modelled	Actual	Comment	Reference
G	375	LEU	-	insertion	UNP P39077

Continued on next page...

Continued from previous page...

Chain	Residue	Modelled	Actual	Comment	Reference
G	376	GLU	-	insertion	UNP P39077
G	377	GLY	-	insertion	UNP P39077
G	378	SER	-	insertion	UNP P39077
G	379	GLY	-	insertion	UNP P39077
G	380	SER	-	insertion	UNP P39077
G	381	GLY	-	insertion	UNP P39077
G	382	TRP	-	insertion	UNP P39077
G	383	SER	-	insertion	UNP P39077
G	384	HIS	-	insertion	UNP P39077
G	385	PRO	-	insertion	UNP P39077
G	386	GLN	-	insertion	UNP P39077
G	387	PHE	-	insertion	UNP P39077
G	388	GLU	-	insertion	UNP P39077
G	389	LYS	-	insertion	UNP P39077
G	390	GLY	-	insertion	UNP P39077
G	391	SER	-	insertion	UNP P39077
G	392	GLY	-	insertion	UNP P39077
G	393	LYS	-	insertion	UNP P39077
G	394	ARG	-	insertion	UNP P39077
G	395	ARG	-	insertion	UNP P39077
G	396	TRP	-	insertion	UNP P39077
G	397	LYS	-	insertion	UNP P39077
G	398	LYS	-	insertion	UNP P39077
G	399	ASN	-	insertion	UNP P39077
G	400	PHE	-	insertion	UNP P39077
G	401	ILE	-	insertion	UNP P39077
G	402	ALA	-	insertion	UNP P39077
G	403	VAL	-	insertion	UNP P39077
G	404	SER	-	insertion	UNP P39077
G	405	ALA	-	insertion	UNP P39077
G	406	ALA	-	insertion	UNP P39077
G	407	ASN	-	insertion	UNP P39077
G	408	ARG	-	insertion	UNP P39077
G	409	PHE	-	insertion	UNP P39077
G	410	LYS	-	insertion	UNP P39077
G	411	LYS	-	insertion	UNP P39077
G	412	ILE	-	insertion	UNP P39077
G	413	SER	-	insertion	UNP P39077
G	414	SER	-	insertion	UNP P39077
G	415	SER	-	insertion	UNP P39077
G	416	GLY	-	insertion	UNP P39077
G	417	ALA	-	insertion	UNP P39077

Continued on next page...

Continued from previous page...

Chain	Residue	Modelled	Actual	Comment	Reference
G	418	LEU	-	insertion	UNP P39077
G	419	GLY	-	insertion	UNP P39077
G	420	SER	-	insertion	UNP P39077
G	421	GLY	-	insertion	UNP P39077
G	422	HIS	-	insertion	UNP P39077
G	423	HIS	-	insertion	UNP P39077
G	424	HIS	-	insertion	UNP P39077
G	425	HIS	-	insertion	UNP P39077
G	426	HIS	-	insertion	UNP P39077
G	427	HIS	-	insertion	UNP P39077
G	428	HIS	-	insertion	UNP P39077
G	429	HIS	-	insertion	UNP P39077
G	430	GLY	-	insertion	UNP P39077
G	431	SER	-	insertion	UNP P39077
G	432	GLY	-	insertion	UNP P39077
G	433	LEU	-	insertion	UNP P39077
G	434	GLN	-	insertion	UNP P39077
g	375	LEU	-	insertion	UNP P39077
g	376	GLU	-	insertion	UNP P39077
g	377	GLY	-	insertion	UNP P39077
g	378	SER	-	insertion	UNP P39077
g	379	GLY	-	insertion	UNP P39077
g	380	SER	-	insertion	UNP P39077
g	381	GLY	-	insertion	UNP P39077
g	382	TRP	-	insertion	UNP P39077
g	383	SER	-	insertion	UNP P39077
g	384	HIS	-	insertion	UNP P39077
g	385	PRO	-	insertion	UNP P39077
g	386	GLN	-	insertion	UNP P39077
g	387	PHE	-	insertion	UNP P39077
g	388	GLU	-	insertion	UNP P39077
g	389	LYS	-	insertion	UNP P39077
g	390	GLY	-	insertion	UNP P39077
g	391	SER	-	insertion	UNP P39077
g	392	GLY	-	insertion	UNP P39077
g	393	LYS	-	insertion	UNP P39077
g	394	ARG	-	insertion	UNP P39077
g	395	ARG	-	insertion	UNP P39077
g	396	TRP	-	insertion	UNP P39077
g	397	LYS	-	insertion	UNP P39077
g	398	LYS	-	insertion	UNP P39077
g	399	ASN	-	insertion	UNP P39077

Continued on next page...

Continued from previous page...

Chain	Residue	Modelled	Actual	Comment	Reference
g	400	PHE	-	insertion	UNP P39077
g	401	ILE	-	insertion	UNP P39077
g	402	ALA	-	insertion	UNP P39077
g	403	VAL	-	insertion	UNP P39077
g	404	SER	-	insertion	UNP P39077
g	405	ALA	-	insertion	UNP P39077
g	406	ALA	-	insertion	UNP P39077
g	407	ASN	-	insertion	UNP P39077
g	408	ARG	-	insertion	UNP P39077
g	409	PHE	-	insertion	UNP P39077
g	410	LYS	-	insertion	UNP P39077
g	411	LYS	-	insertion	UNP P39077
g	412	ILE	-	insertion	UNP P39077
g	413	SER	-	insertion	UNP P39077
g	414	SER	-	insertion	UNP P39077
g	415	SER	-	insertion	UNP P39077
g	416	GLY	-	insertion	UNP P39077
g	417	ALA	-	insertion	UNP P39077
g	418	LEU	-	insertion	UNP P39077
g	419	GLY	-	insertion	UNP P39077
g	420	SER	-	insertion	UNP P39077
g	421	GLY	-	insertion	UNP P39077
g	422	HIS	-	insertion	UNP P39077
g	423	HIS	-	insertion	UNP P39077
g	424	HIS	-	insertion	UNP P39077
g	425	HIS	-	insertion	UNP P39077
g	426	HIS	-	insertion	UNP P39077
g	427	HIS	-	insertion	UNP P39077
g	428	HIS	-	insertion	UNP P39077
g	429	HIS	-	insertion	UNP P39077
g	430	GLY	-	insertion	UNP P39077
g	431	SER	-	insertion	UNP P39077
g	432	GLY	-	insertion	UNP P39077
g	433	LEU	-	insertion	UNP P39077
g	434	GLN	-	insertion	UNP P39077

- Molecule 5 is a protein called T-complex protein 1 subunit eta.

Mol	Chain	Residues	Atoms					AltConf	Trace
5	H	507	Total	C	N	O	S	0	0
			3887	2450	665	753	19		
5	h	506	Total	C	N	O	S	0	0
			3878	2445	663	751	19		

- Molecule 6 is a protein called T-complex protein 1 subunit theta.

Mol	Chain	Residues	Atoms					AltConf	Trace
6	Q	525	Total	C	N	O	S	0	0
			3986	2512	678	770	26		
6	q	525	Total	C	N	O	S	0	0
			3986	2512	678	770	26		

- Molecule 7 is a protein called T-complex protein 1 subunit zeta.

Mol	Chain	Residues	Atoms					AltConf	Trace
7	z	515	Total	C	N	O	S	0	0
			3954	2482	683	772	17		
7	Z	508	Total	C	N	O	S	0	0
			3898	2450	675	756	17		

- Molecule 8 is a protein called T-complex protein 1 subunit delta.

Mol	Chain	Residues	Atoms					AltConf	Trace
8	D	523	Total	C	N	O	S	0	0
			3998	2492	711	778	17		
8	d	524	Total	C	N	O	S	0	0
			4005	2497	712	779	17		

3 Residue-property plots

These plots are drawn for all protein, RNA, DNA and oligosaccharide chains in the entry. The first graphic for a chain summarises the proportions of the various outlier classes displayed in the second graphic. The second graphic shows the sequence view annotated by issues in geometry and atom inclusion in map density. Residues are color-coded according to the number of geometric quality criteria for which they contain at least one outlier: green = 0, yellow = 1, orange = 2 and red = 3 or more. A red diamond above a residue indicates a poor fit to the EM map for this residue (all-atom inclusion < 40%). Stretches of 2 or more consecutive residues without any outlier are shown as a green connector. Residues present in the sample, but not in the model, are shown in grey.

- Molecule 1: T-complex protein 1 subunit alpha

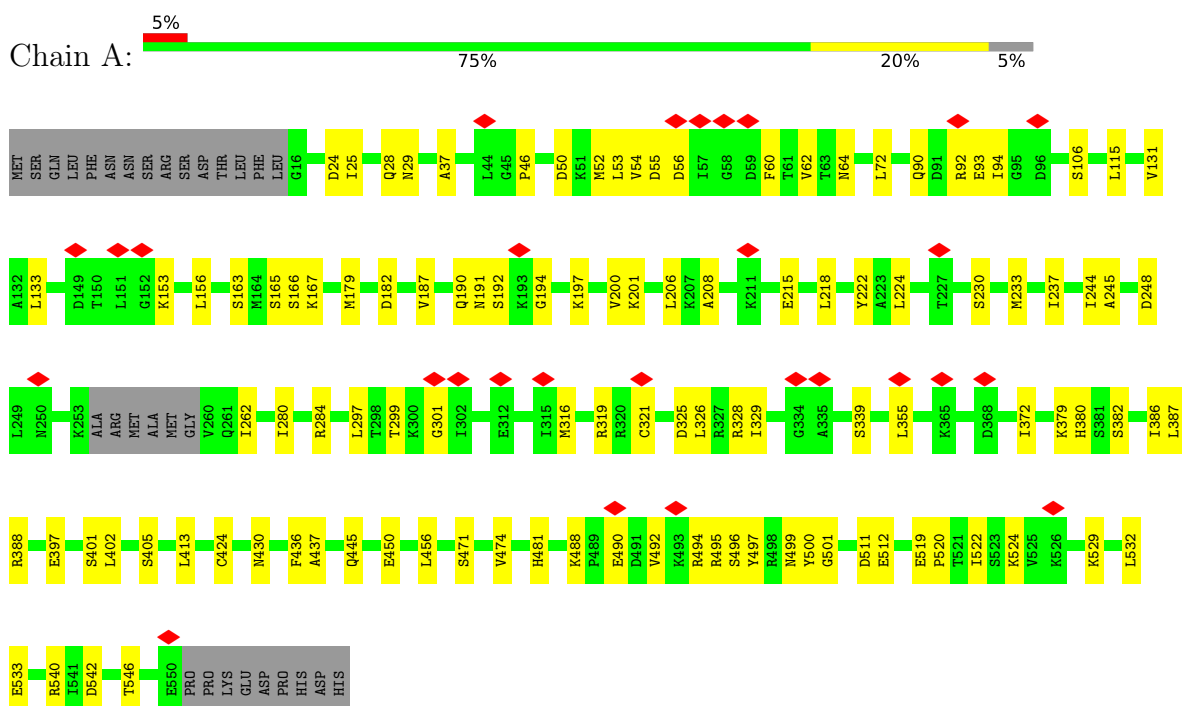

- Molecule 1: T-complex protein 1 subunit alpha

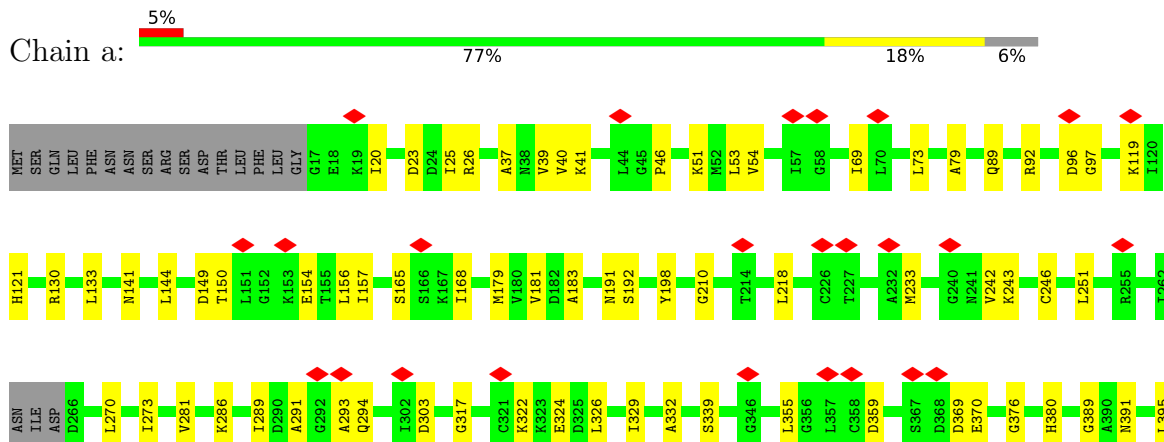

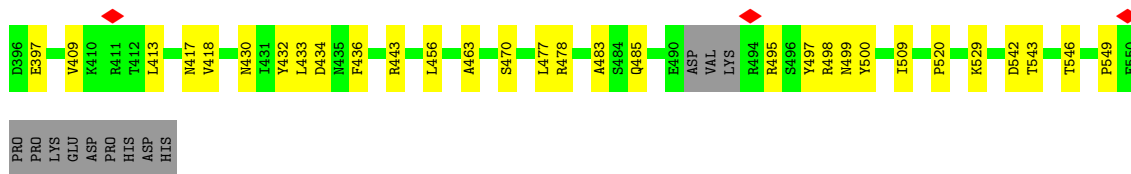

• Molecule 2: T-complex protein 1 subunit beta

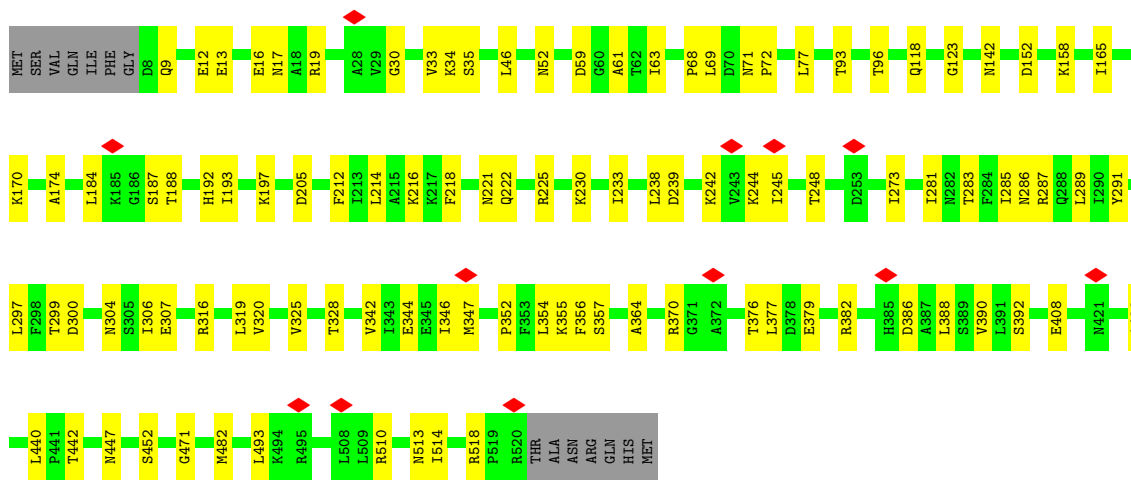
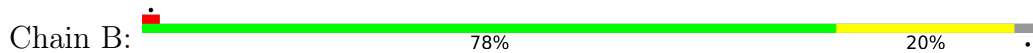

• Molecule 2: T-complex protein 1 subunit beta

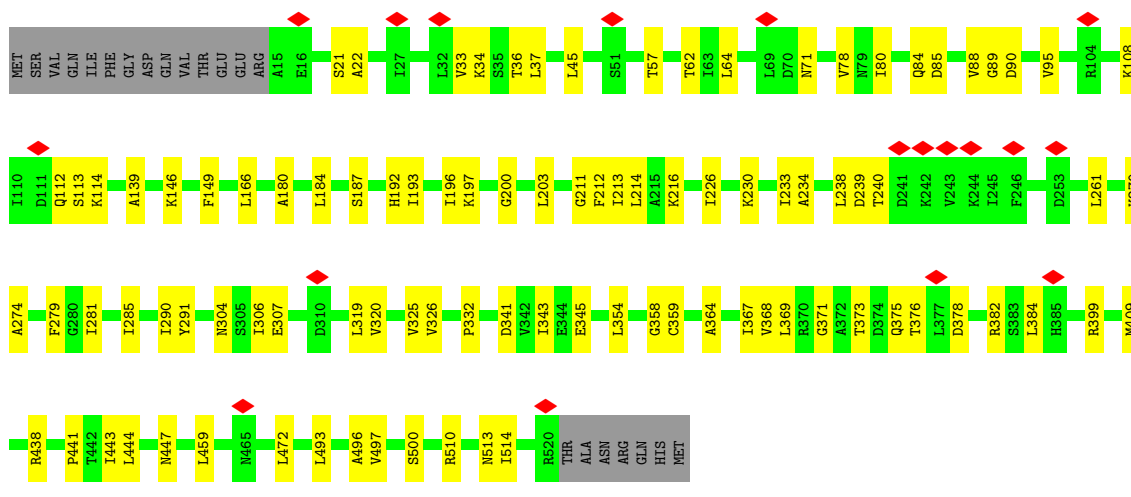
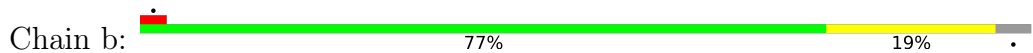

• Molecule 3: T-complex protein 1 subunit epsilon

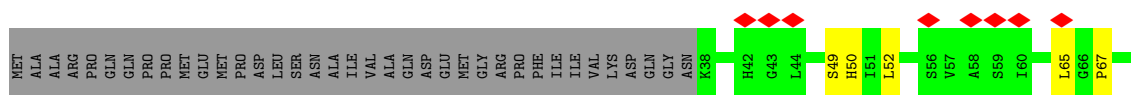

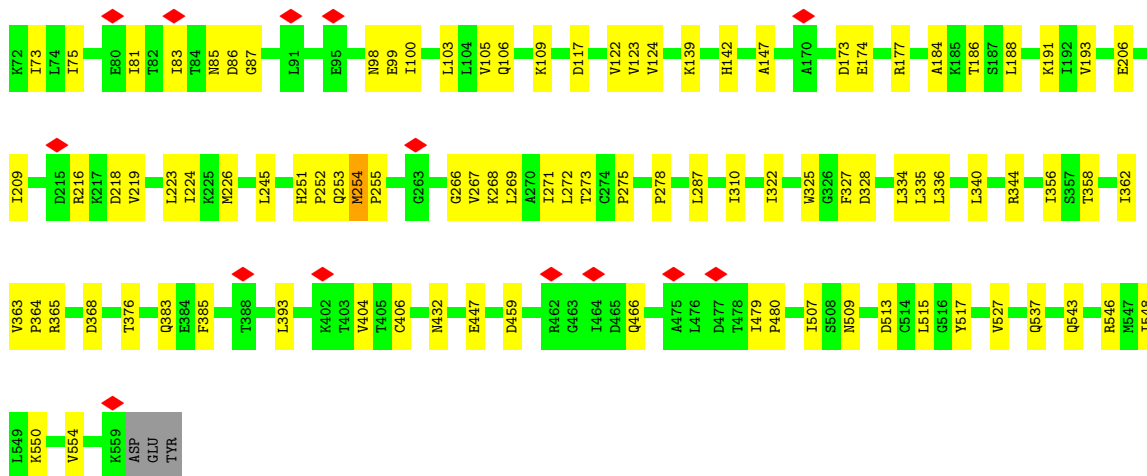

• Molecule 3: T-complex protein 1 subunit epsilon

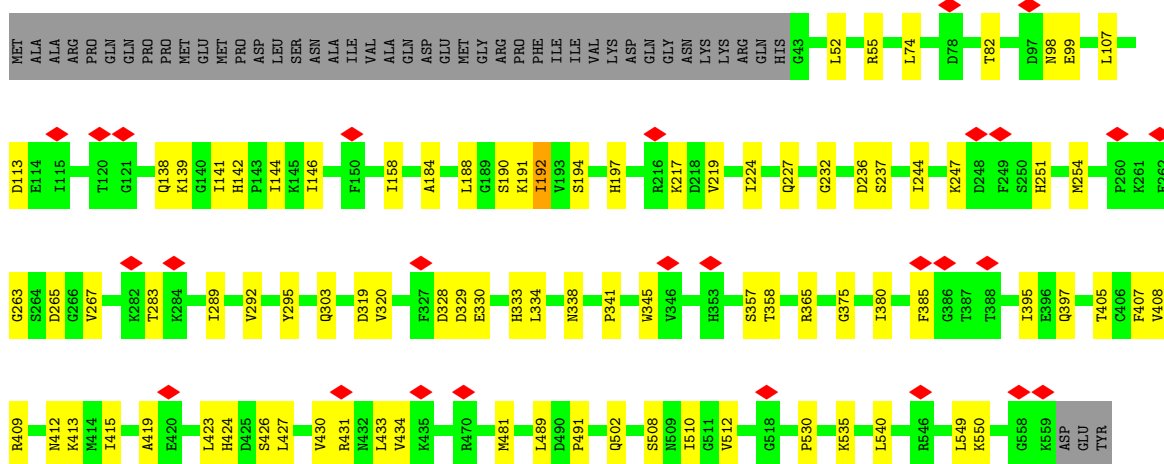
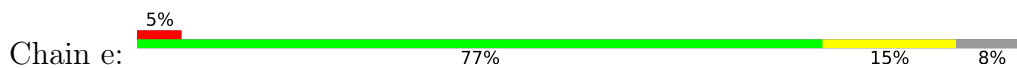

• Molecule 4: T-complex protein 1 subunit gamma

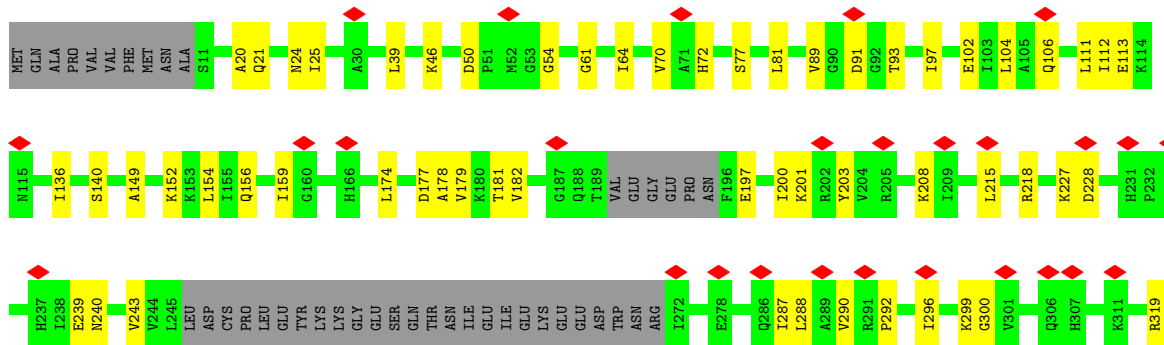

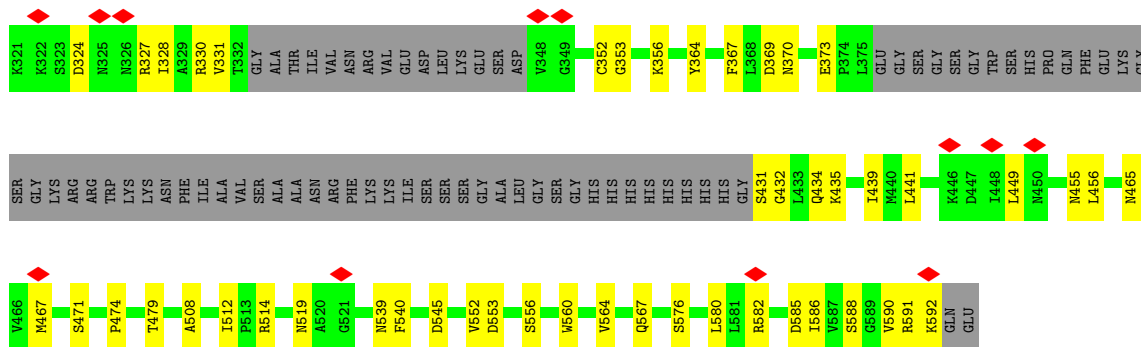

• Molecule 4: T-complex protein 1 subunit gamma

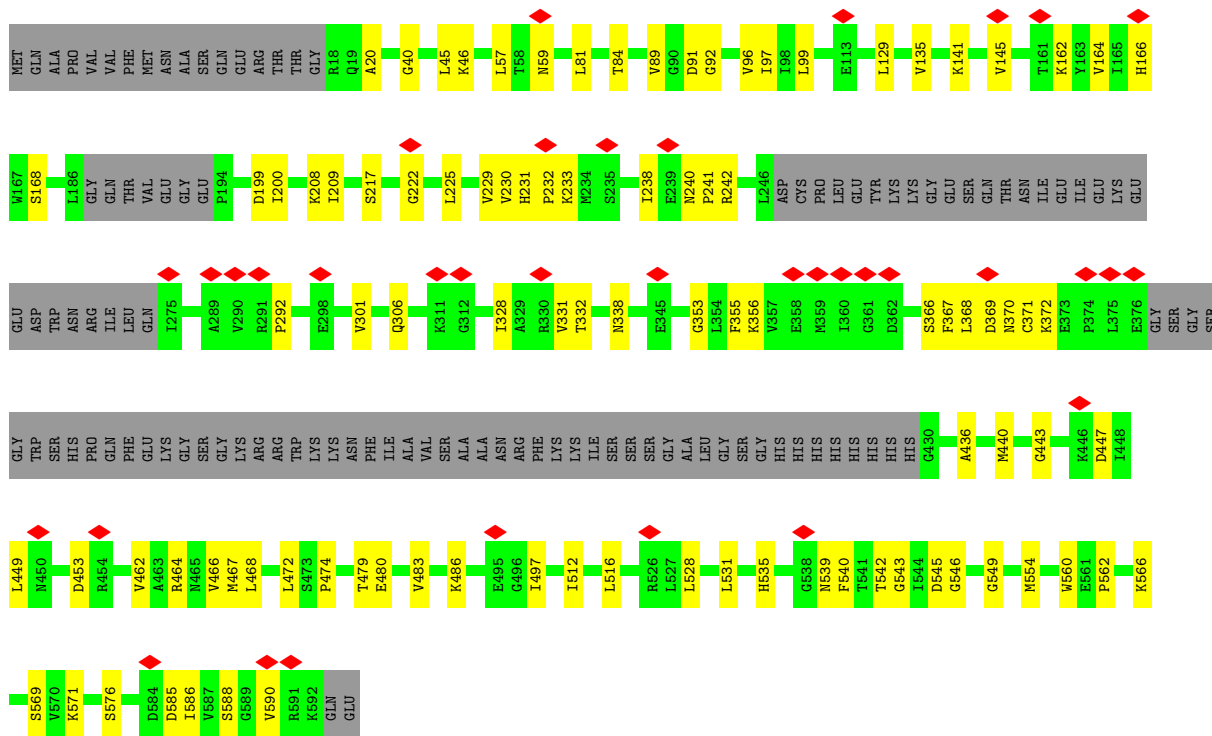

• Molecule 5: T-complex protein 1 subunit eta

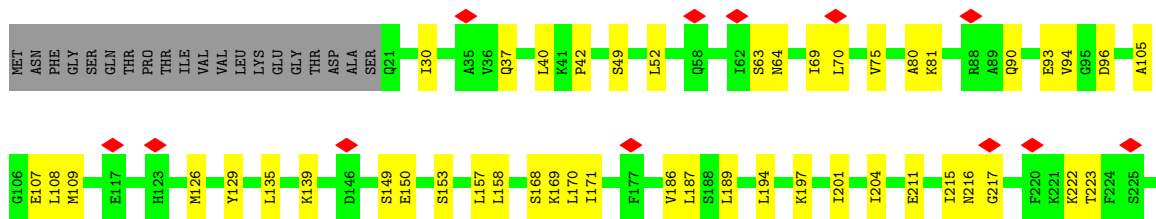

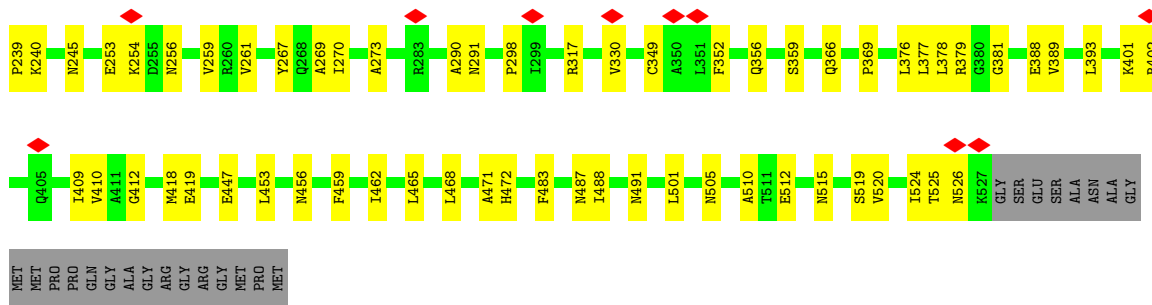

• Molecule 5: T-complex protein 1 subunit eta

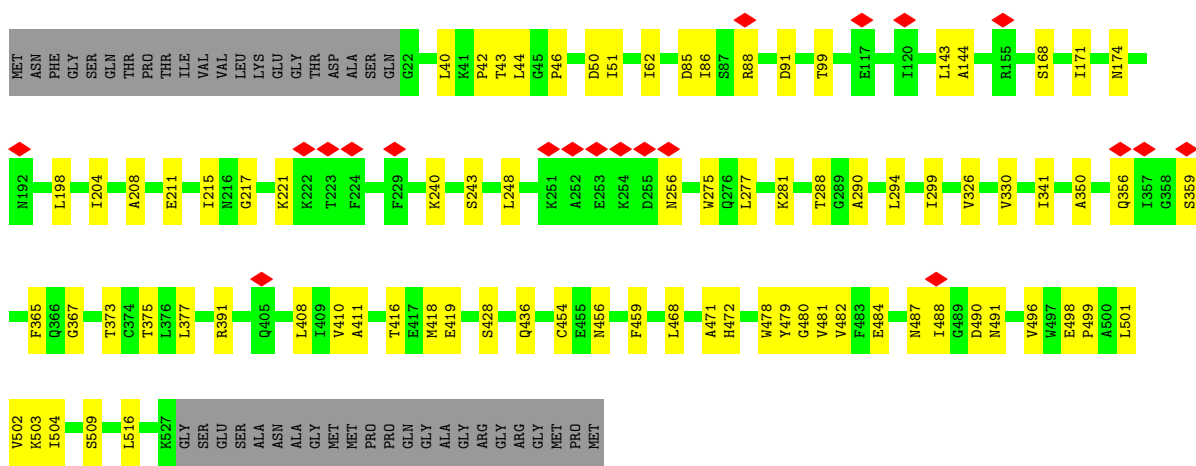
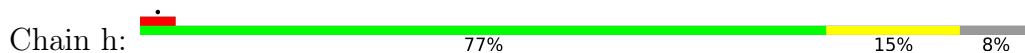

• Molecule 6: T-complex protein 1 subunit theta

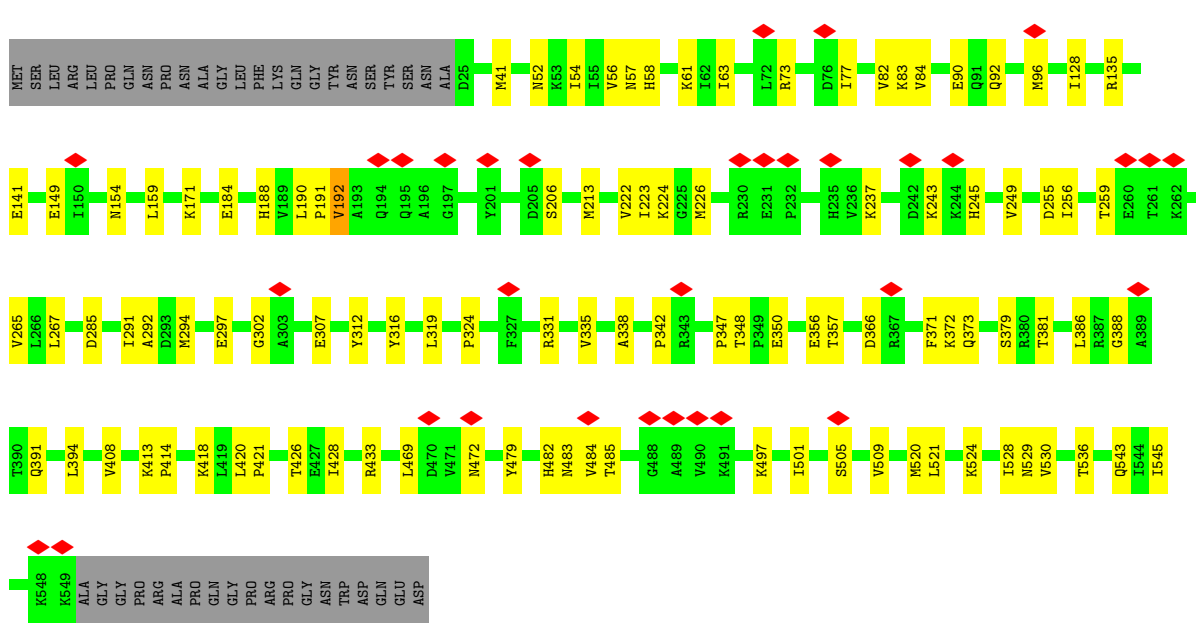

• Molecule 6: T-complex protein 1 subunit theta

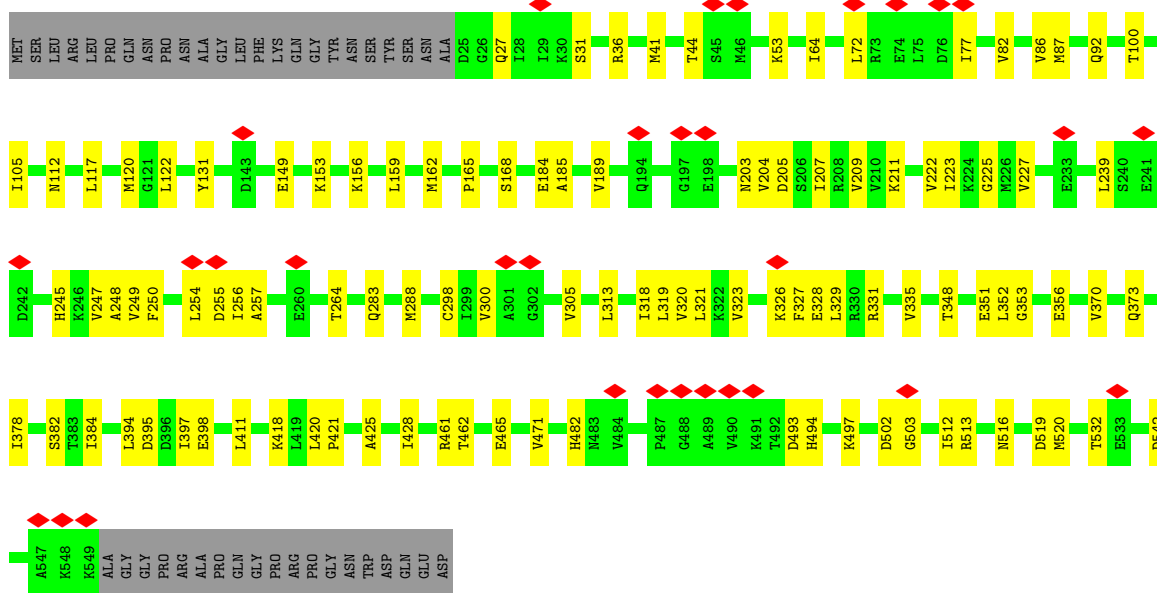
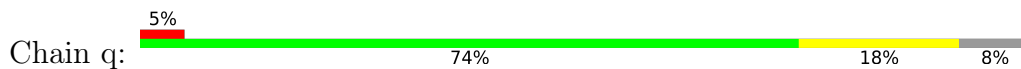

• Molecule 7: T-complex protein 1 subunit zeta

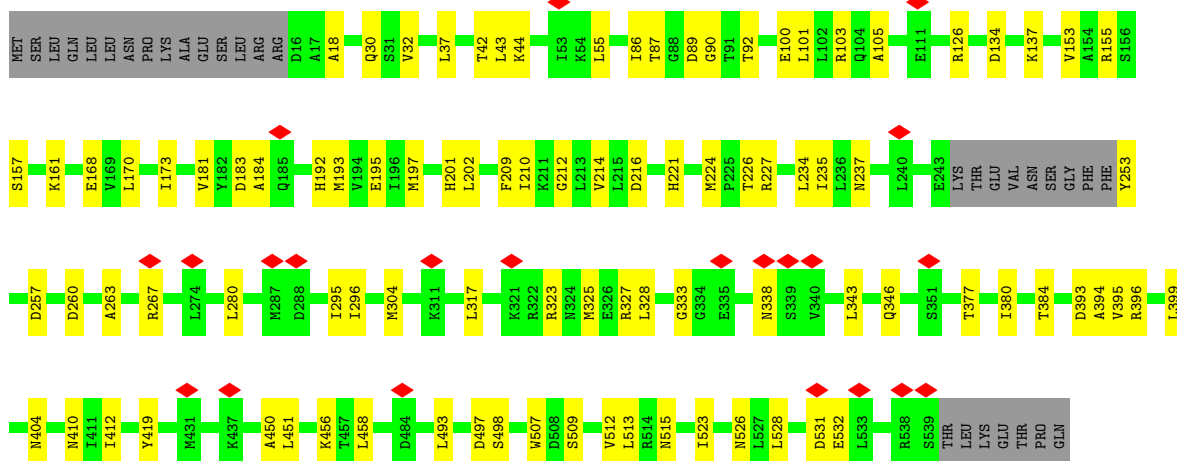
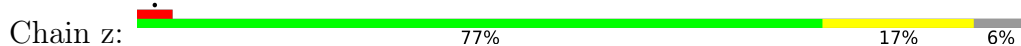

• Molecule 7: T-complex protein 1 subunit zeta

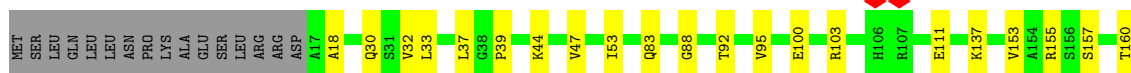
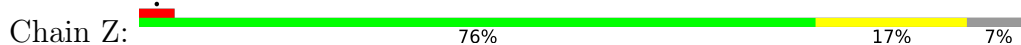

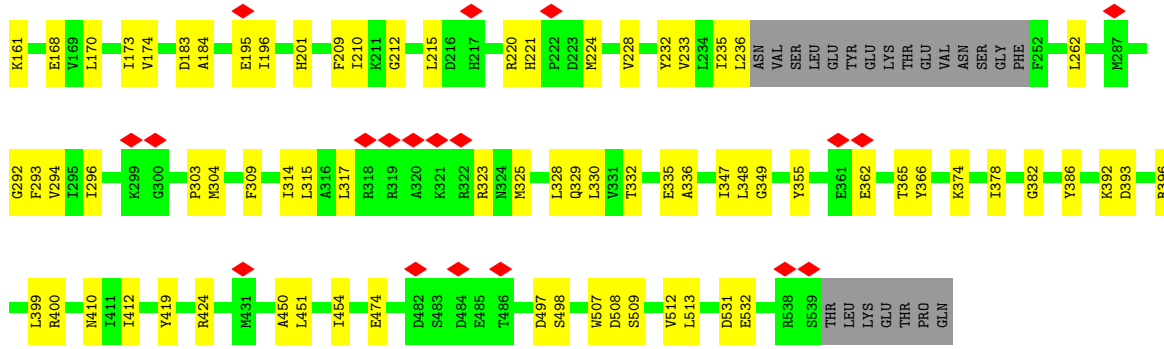

• Molecule 8: T-complex protein 1 subunit delta

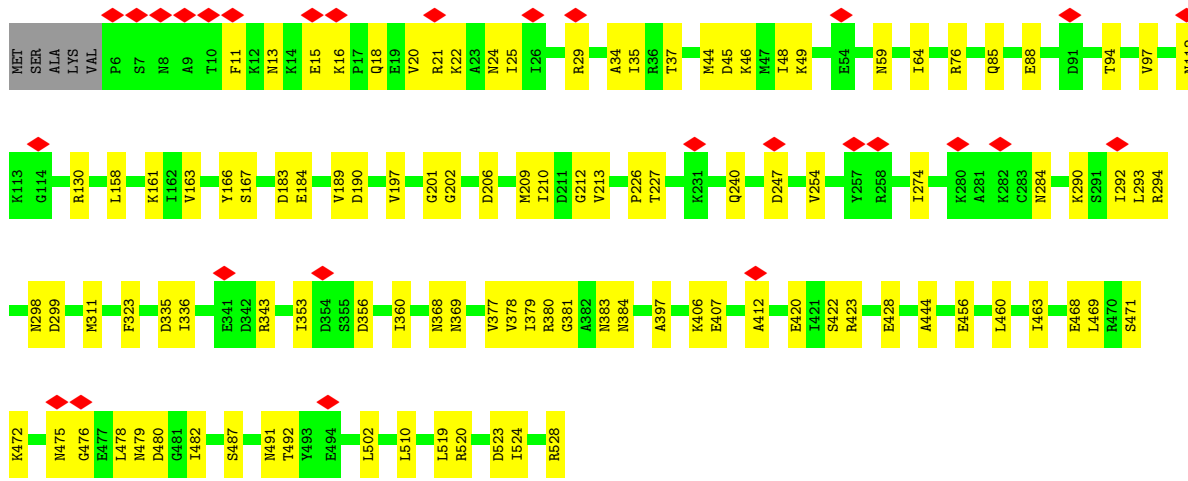
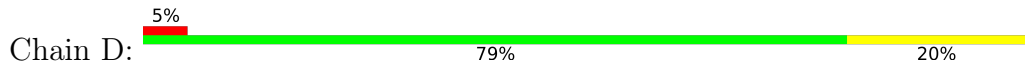

• Molecule 8: T-complex protein 1 subunit delta

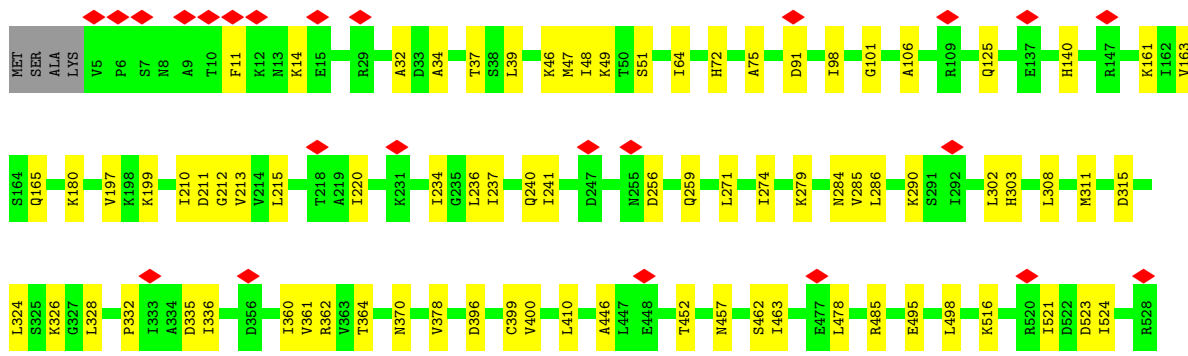
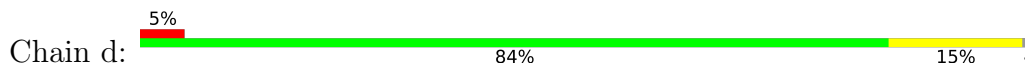

4 Experimental information

Property	Value	Source
EM reconstruction method	SINGLE PARTICLE	Depositor
Imposed symmetry	POINT, Not provided	
Number of particles used	45923	Depositor
Resolution determination method	FSC 0.143 CUT-OFF	Depositor
CTF correction method	NONE	Depositor
Microscope	TFS KRIOS	Depositor
Voltage (kV)	300	Depositor
Electron dose ($e^-/\text{\AA}^2$)	38	Depositor
Minimum defocus (nm)	1200	Depositor
Maximum defocus (nm)	2400	Depositor
Magnification	Not provided	
Image detector	GATAN K2 SUMMIT (4k x 4k)	Depositor
Maximum map value	2.396	Depositor
Minimum map value	-1.075	Depositor
Average map value	0.021	Depositor
Map value standard deviation	0.138	Depositor
Recommended contour level	0.5	Depositor
Map size (\AA)	337.408, 337.408, 337.408	wwPDB
Map dimensions	256, 256, 256	wwPDB
Map angles ($^\circ$)	90.0, 90.0, 90.0	wwPDB
Pixel spacing (\AA)	1.318, 1.318, 1.318	Depositor

5 Model quality [i](#)

5.1 Standard geometry [i](#)

The Z score for a bond length (or angle) is the number of standard deviations the observed value is removed from the expected value. A bond length (or angle) with $|Z| > 5$ is considered an outlier worth inspection. RMSZ is the root-mean-square of all Z scores of the bond lengths (or angles).

Mol	Chain	Bond lengths		Bond angles	
		RMSZ	# Z >5	RMSZ	# Z >5
1	A	0.08	0/4029	0.26	0/5437
1	a	0.09	0/4017	0.27	0/5417
2	B	0.07	0/3936	0.26	0/5304
2	b	0.09	0/3876	0.26	0/5223
3	E	0.08	0/4071	0.26	0/5478
3	e	0.08	0/4022	0.26	0/5415
4	G	0.09	0/3711	0.31	0/5003
4	g	0.09	0/3765	0.27	0/5078
5	H	0.08	0/3936	0.27	0/5311
5	h	0.07	0/3927	0.24	0/5299
6	Q	0.08	0/4032	0.26	0/5442
6	q	0.08	0/4032	0.27	0/5442
7	Z	0.08	0/3946	0.24	0/5331
7	z	0.07	0/4002	0.23	0/5408
8	D	0.09	0/4036	0.27	1/5440 (0.0%)
8	d	0.08	0/4043	0.27	1/5451 (0.0%)
All	All	0.08	0/63381	0.26	2/85479 (0.0%)

There are no bond length outliers.

All (2) bond angle outliers are listed below:

Mol	Chain	Res	Type	Atoms	Z	Observed(°)	Ideal(°)
8	D	227	THR	CB-CA-C	-6.70	108.86	116.63
8	d	11	PHE	CB-CA-C	-6.07	108.97	117.23

There are no chirality outliers.

There are no planarity outliers.

5.2 Too-close contacts [i](#)

In the following table, the Non-H and H(model) columns list the number of non-hydrogen atoms and hydrogen atoms in the chain respectively. The H(added) column lists the number of hydrogen

atoms added and optimized by MolProbity. The Clashes column lists the number of clashes within the asymmetric unit, whereas Symm-Clashes lists symmetry-related clashes.

Mol	Chain	Non-H	H(model)	H(added)	Clashes	Symm-Clashes
1	A	3994	0	4155	67	0
1	a	3983	0	4148	61	0
2	B	3898	0	4003	75	0
2	b	3838	0	3950	64	0
3	E	4022	0	4125	84	0
3	e	3974	0	4071	54	0
4	G	3673	0	3841	62	0
4	g	3725	0	3891	64	0
5	H	3887	0	3969	70	0
5	h	3878	0	3961	45	0
6	Q	3986	0	4136	70	0
6	q	3986	0	4136	68	0
7	Z	3898	0	3993	59	0
7	z	3954	0	4040	59	0
8	D	3998	0	4170	71	0
8	d	4005	0	4178	52	0
All	All	62699	0	64767	932	0

The all-atom clashscore is defined as the number of clashes found per 1000 atoms (including hydrogen atoms). The all-atom clashscore for this structure is 7.

The worst 5 of 932 close contacts within the same asymmetric unit are listed below, sorted by their clash magnitude.

Atom-1	Atom-2	Interatomic distance (Å)	Clash overlap (Å)
3:E:254:MET:HG2	3:E:255:PRO:CD	1.17	1.59
3:E:254:MET:CG	3:E:255:PRO:HD2	1.42	1.48
3:E:254:MET:CG	3:E:255:PRO:CD	2.13	1.06
3:E:254:MET:HG2	3:E:255:PRO:HD3	1.48	0.96
3:E:254:MET:HB2	3:E:336:LEU:HD13	1.49	0.93

There are no symmetry-related clashes.

5.3 Torsion angles [i](#)

5.3.1 Protein backbone [i](#)

In the following table, the Percentiles column shows the percent Ramachandran outliers of the chain as a percentile score with respect to all PDB entries followed by that with respect to all EM entries.

The Analysed column shows the number of residues for which the backbone conformation was analysed, and the total number of residues.

Mol	Chain	Analysed	Favoured	Allowed	Outliers	Percentiles	
1	A	525/559 (94%)	490 (93%)	34 (6%)	1 (0%)	43	77
1	a	522/559 (93%)	496 (95%)	26 (5%)	0	100	100
2	B	511/527 (97%)	490 (96%)	20 (4%)	1 (0%)	43	77
2	b	504/527 (96%)	475 (94%)	29 (6%)	0	100	100
3	E	520/562 (92%)	487 (94%)	30 (6%)	3 (1%)	21	59
3	e	515/562 (92%)	484 (94%)	30 (6%)	1 (0%)	43	77
4	G	470/594 (79%)	443 (94%)	27 (6%)	0	100	100
4	g	479/594 (81%)	457 (95%)	22 (5%)	0	100	100
5	H	505/550 (92%)	471 (93%)	34 (7%)	0	100	100
5	h	504/550 (92%)	474 (94%)	28 (6%)	2 (0%)	30	67
6	Q	523/568 (92%)	492 (94%)	30 (6%)	1 (0%)	43	77
6	q	523/568 (92%)	494 (94%)	29 (6%)	0	100	100
7	Z	504/546 (92%)	478 (95%)	26 (5%)	0	100	100
7	z	511/546 (94%)	484 (95%)	27 (5%)	0	100	100
8	D	521/528 (99%)	482 (92%)	37 (7%)	2 (0%)	30	67
8	d	522/528 (99%)	495 (95%)	27 (5%)	0	100	100
All	All	8159/8868 (92%)	7692 (94%)	456 (6%)	11 (0%)	49	83

5 of 11 Ramachandran outliers are listed below:

Mol	Chain	Res	Type
3	E	193	VAL
3	E	267	VAL
3	e	192	ILE
1	A	492	VAL
6	Q	192	VAL

5.3.2 Protein sidechains [i](#)

In the following table, the Percentiles column shows the percent sidechain outliers of the chain as a percentile score with respect to all PDB entries followed by that with respect to all EM entries.

The Analysed column shows the number of residues for which the sidechain conformation was analysed, and the total number of residues.

Mol	Chain	Analysed	Rotameric	Outliers	Percentiles	
1	A	444/471 (94%)	444 (100%)	0	100	100
1	a	441/471 (94%)	441 (100%)	0	100	100
2	B	429/441 (97%)	429 (100%)	0	100	100
2	b	422/441 (96%)	422 (100%)	0	100	100
3	E	449/483 (93%)	448 (100%)	1 (0%)	87	86
3	e	444/483 (92%)	444 (100%)	0	100	100
4	G	406/501 (81%)	406 (100%)	0	100	100
4	g	412/501 (82%)	412 (100%)	0	100	100
5	H	423/454 (93%)	423 (100%)	0	100	100
5	h	422/454 (93%)	422 (100%)	0	100	100
6	Q	440/473 (93%)	440 (100%)	0	100	100
6	q	440/473 (93%)	440 (100%)	0	100	100
7	Z	427/463 (92%)	427 (100%)	0	100	100
7	z	434/463 (94%)	434 (100%)	0	100	100
8	D	449/453 (99%)	449 (100%)	0	100	100
8	d	450/453 (99%)	450 (100%)	0	100	100
All	All	6932/7478 (93%)	6931 (100%)	1 (0%)	100	100

All (1) residues with a non-rotameric sidechain are listed below:

Mol	Chain	Res	Type
3	E	254	MET

Sometimes sidechains can be flipped to improve hydrogen bonding and reduce clashes. 5 of 78 such sidechains are listed below:

Mol	Chain	Res	Type
6	q	39	HIS
8	d	67	GLN
6	q	245	HIS
7	z	515	ASN
8	d	395	HIS

5.3.3 RNA [i](#)

There are no RNA molecules in this entry.

5.4 Non-standard residues in protein, DNA, RNA chains [i](#)

There are no non-standard protein/DNA/RNA residues in this entry.

5.5 Carbohydrates [i](#)

There are no oligosaccharides in this entry.

5.6 Ligand geometry [i](#)

There are no ligands in this entry.

5.7 Other polymers [i](#)

There are no such residues in this entry.

5.8 Polymer linkage issues [i](#)

There are no chain breaks in this entry.

6 Map visualisation [i](#)

This section contains visualisations of the EMDB entry EMD-45886. These allow visual inspection of the internal detail of the map and identification of artifacts.

No raw map or half-maps were deposited for this entry and therefore no images, graphs, etc. pertaining to the raw map can be shown.

6.1 Orthogonal projections [i](#)

6.1.1 Primary map

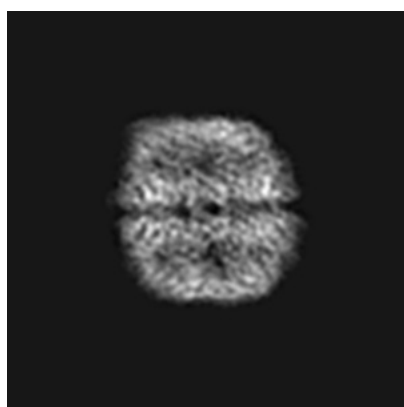

X

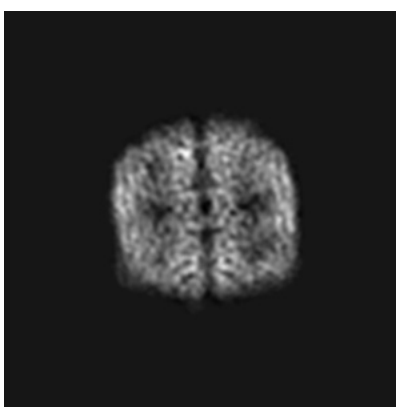

Y

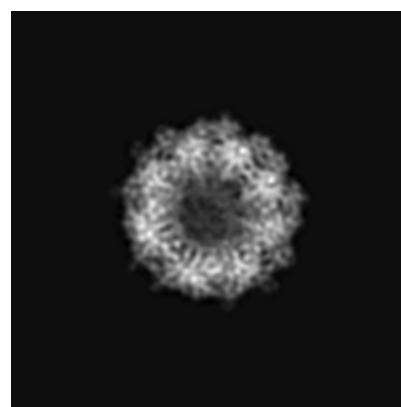

Z

The images above show the map projected in three orthogonal directions.

6.2 Central slices [i](#)

6.2.1 Primary map



X Index: 128



Y Index: 128



Z Index: 128

The images above show central slices of the map in three orthogonal directions.

6.3 Largest variance slices [i](#)

6.3.1 Primary map



X Index: 91



Y Index: 91



Z Index: 117

The images above show the largest variance slices of the map in three orthogonal directions.

6.4 Orthogonal standard-deviation projections (False-color) [i](#)

6.4.1 Primary map

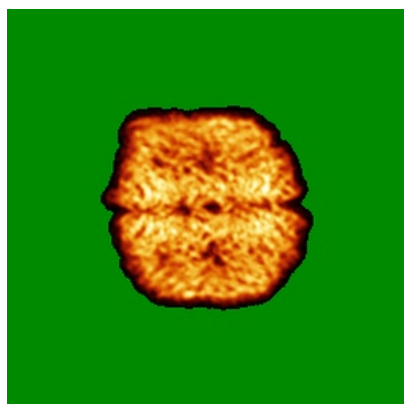

X



Y

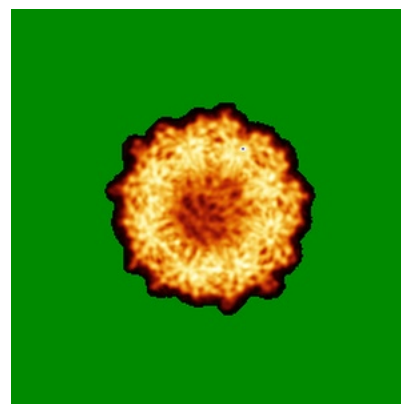

Z

The images above show the map standard deviation projections with false color in three orthogonal directions. Minimum values are shown in green, max in blue, and dark to light orange shades represent small to large values respectively.

6.5 Orthogonal surface views [i](#)

6.5.1 Primary map

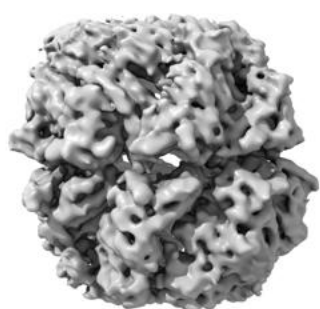

X

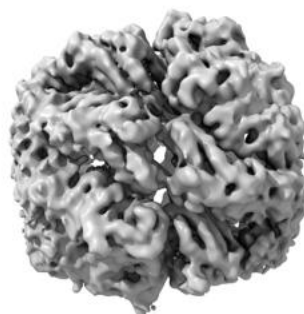

Y

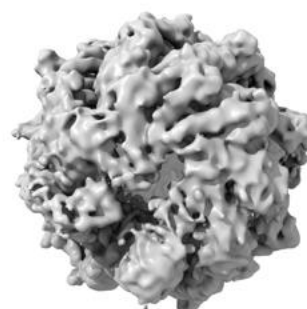

Z

The images above show the 3D surface view of the map at the recommended contour level 0.5. These images, in conjunction with the slice images, may facilitate assessment of whether an appropriate contour level has been provided.

6.6 Mask visualisation [i](#)

This section was not generated. No masks/segmentation were deposited.

7 Map analysis [i](#)

This section contains the results of statistical analysis of the map.

7.1 Map-value distribution [i](#)

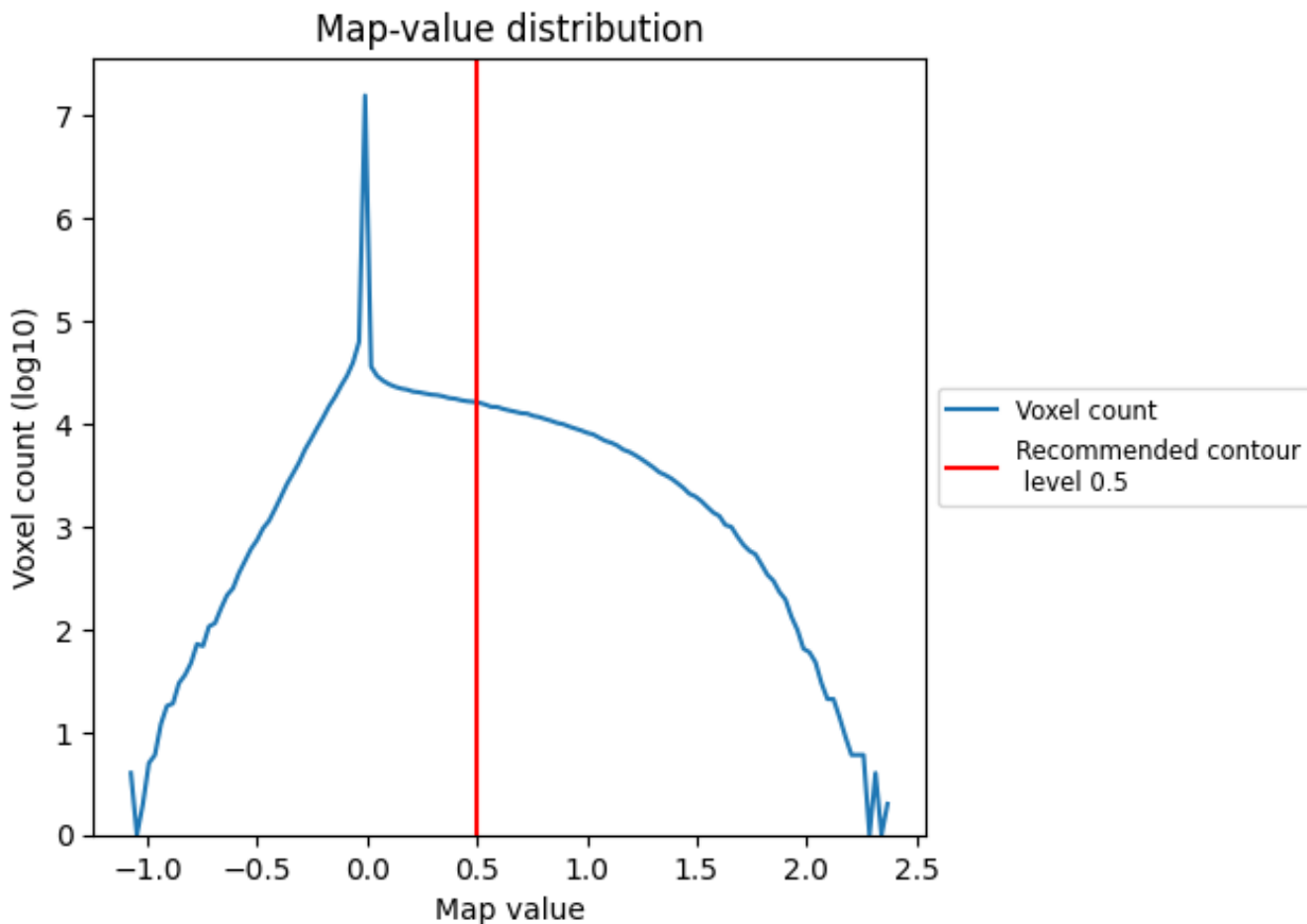

The map-value distribution is plotted in 128 intervals along the x-axis. The y-axis is logarithmic. A spike in this graph at zero usually indicates that the volume has been masked.

7.2 Volume estimate [\(i\)](#)

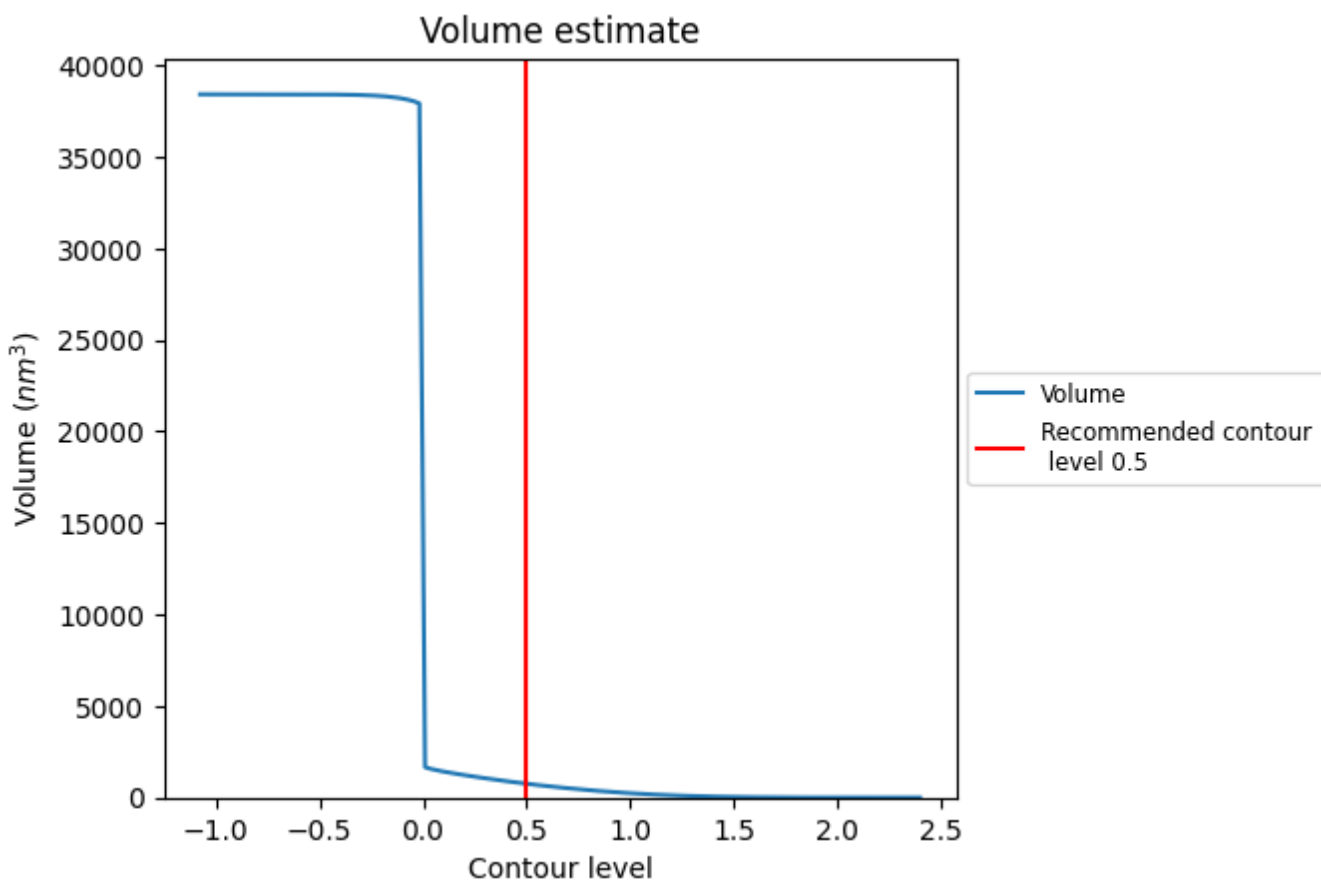

The volume at the recommended contour level is 754 nm^3 ; this corresponds to an approximate mass of 681 kDa.

The volume estimate graph shows how the enclosed volume varies with the contour level. The recommended contour level is shown as a vertical line and the intersection between the line and the curve gives the volume of the enclosed surface at the given level.

7.3 Rotationally averaged power spectrum [i](#)

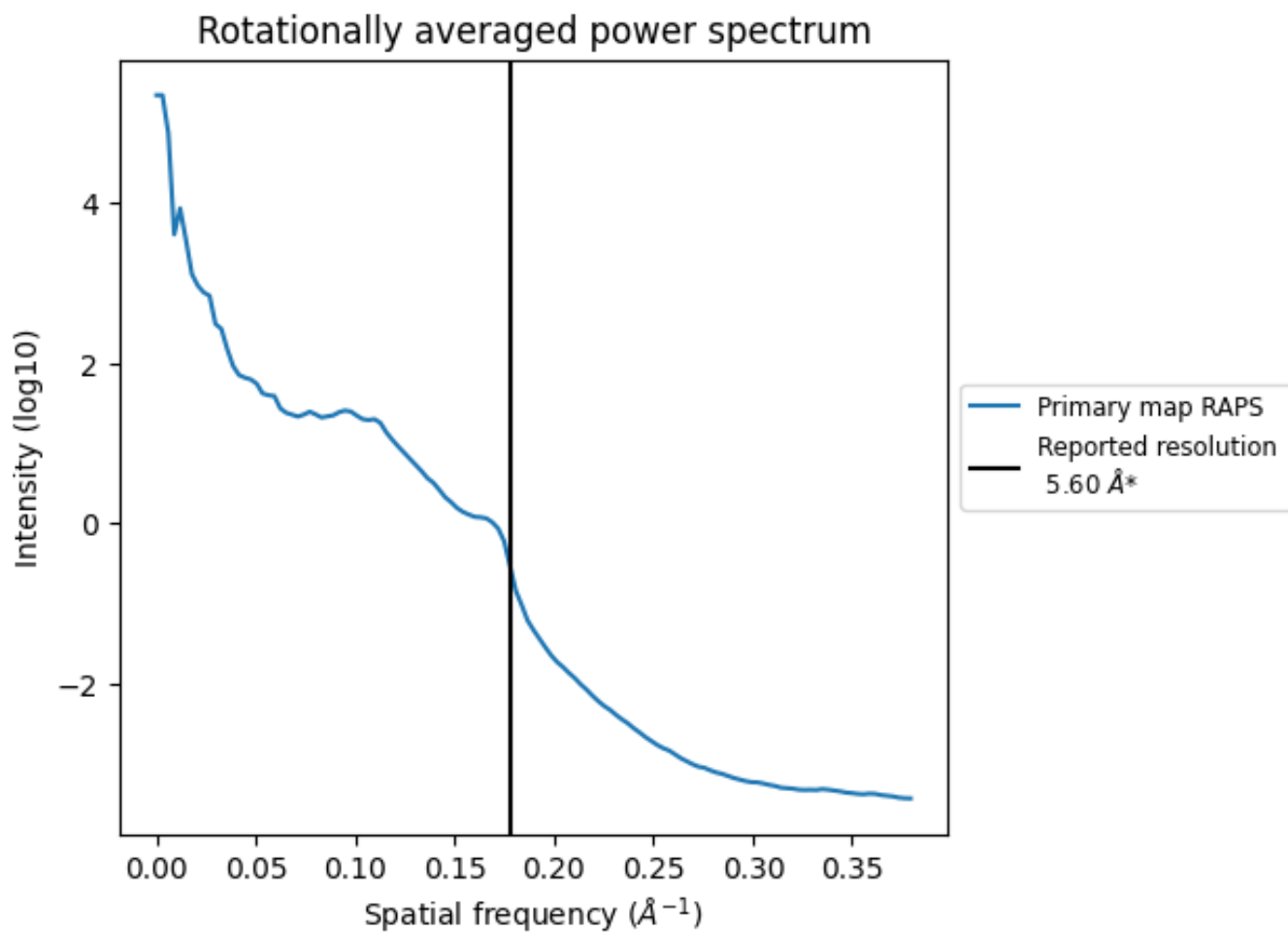

*Reported resolution corresponds to spatial frequency of 0.179\AA^{-1}

8 Fourier-Shell correlation

This section was not generated. No FSC curve or half-maps provided.

9 Map-model fit [i](#)

This section contains information regarding the fit between EMDB map EMD-45886 and PDB model 9CS3. Per-residue inclusion information can be found in section 3 on page 9.

9.1 Map-model overlay [i](#)

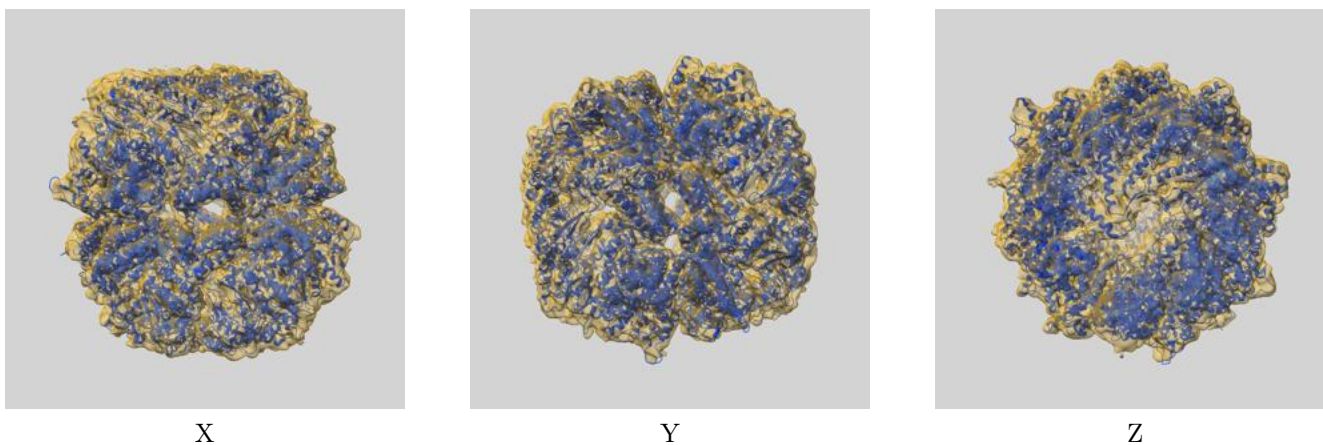

The images above show the 3D surface view of the map at the recommended contour level 0.5 at 50% transparency in yellow overlaid with a ribbon representation of the model coloured in blue. These images allow for the visual assessment of the quality of fit between the atomic model and the map.

9.2 Q-score mapped to coordinate model [i](#)

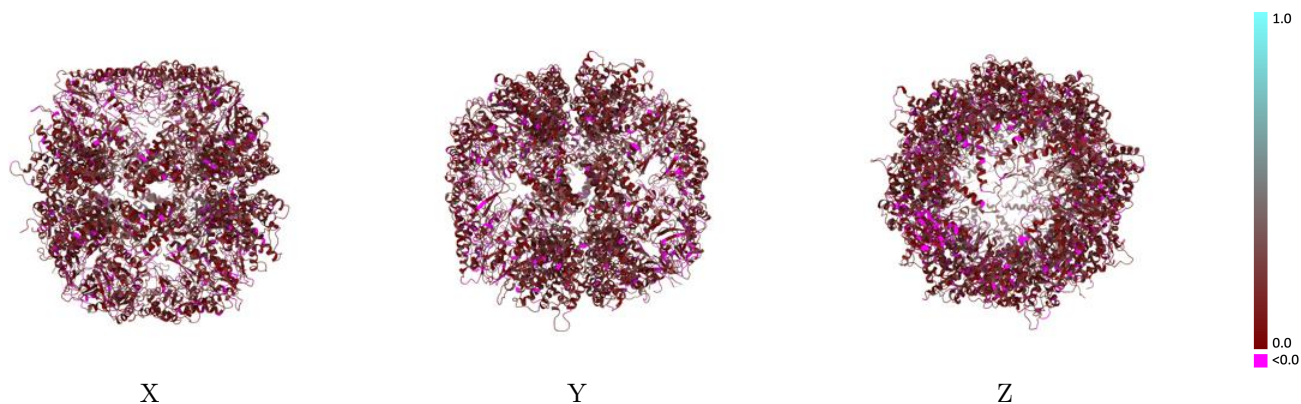

The images above show the model with each residue coloured according to its Q-score. This shows their resolvability in the map with higher Q-score values reflecting better resolvability. Please note: Q-score is calculating the resolvability of atoms, and thus high values are only expected at resolutions at which atoms can be resolved. Low Q-score values may therefore be expected for many entries.

9.3 Atom inclusion mapped to coordinate model [i](#)

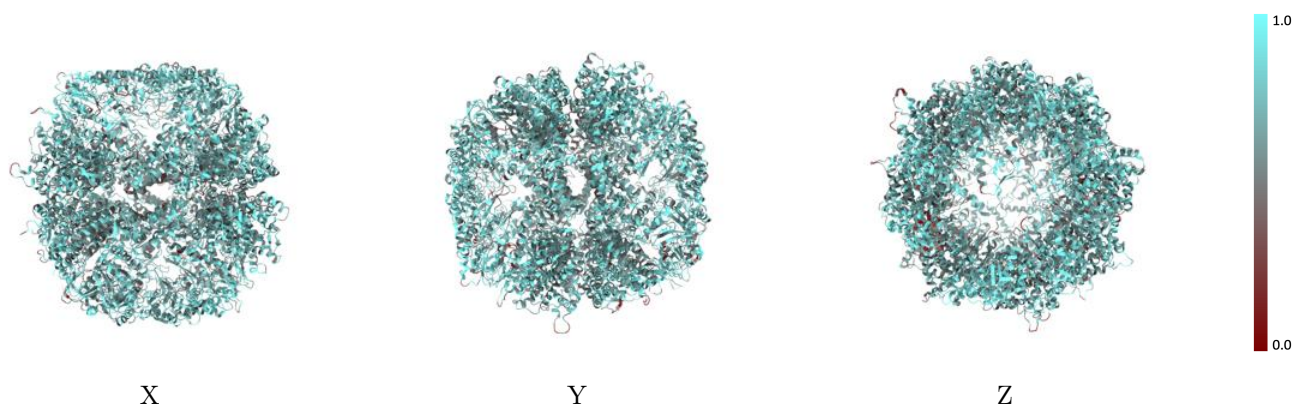

The images above show the model with each residue coloured according to its atom inclusion. This shows to what extent they are inside the map at the recommended contour level (0.5).



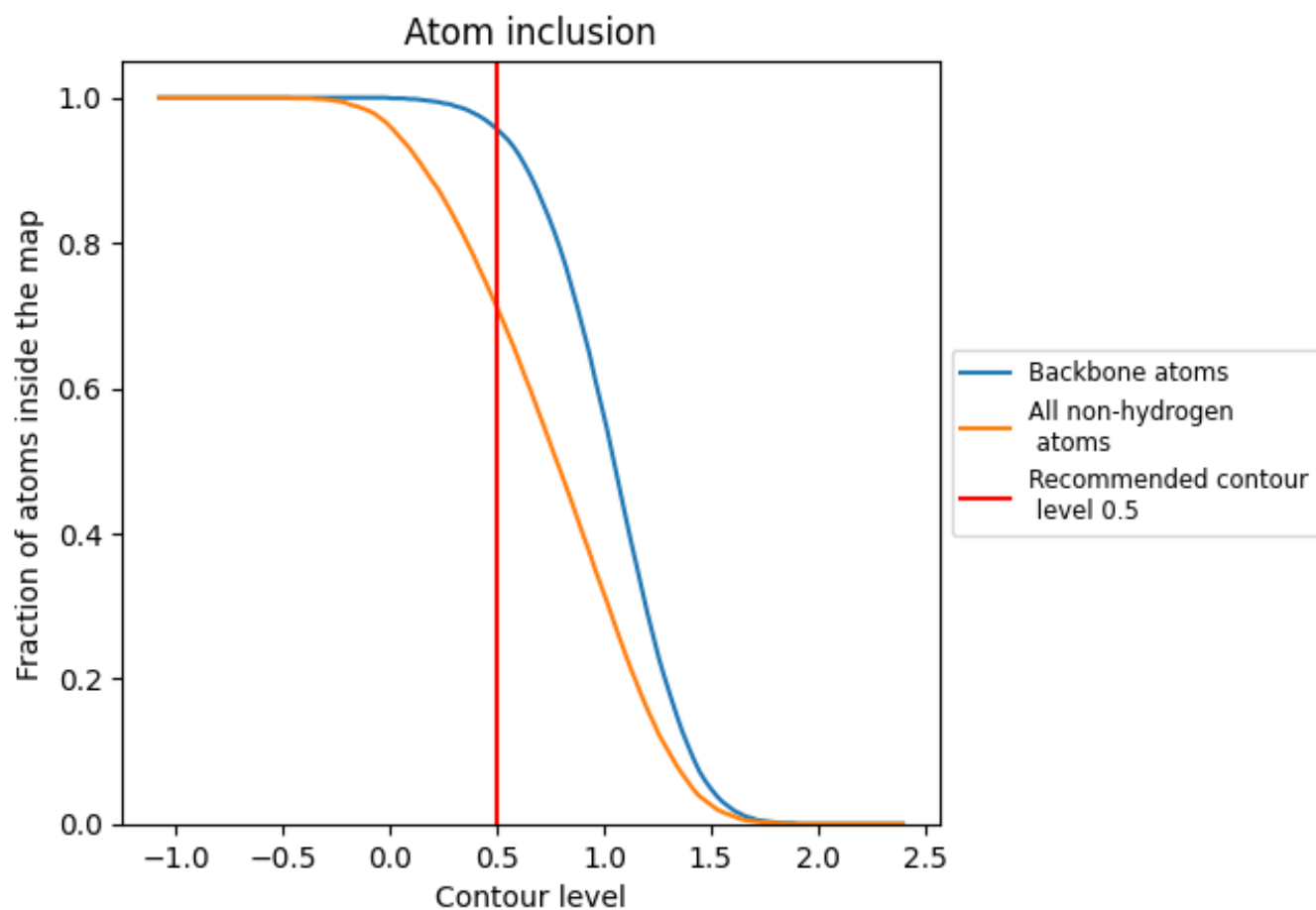































9.4 Atom inclusion [i](#)



At the recommended contour level, 96% of all backbone atoms, 71% of all non-hydrogen atoms, are inside the map.

9.5 Map-model fit summary [i](#)

The table lists the average atom inclusion at the recommended contour level (0.5) and Q-score for the entire model and for each chain.

Chain	Atom inclusion	Q-score
All	 0.7120	 0.1490
A	 0.7130	 0.1500
B	 0.7360	 0.1630
D	 0.7120	 0.1540
E	 0.7290	 0.1580
G	 0.6940	 0.1260
H	 0.7030	 0.1460
Q	 0.7060	 0.1490
Z	 0.7280	 0.1490
a	 0.7080	 0.1530
b	 0.7140	 0.1530
d	 0.7160	 0.1520
e	 0.7120	 0.1480
g	 0.6880	 0.1280
h	 0.7090	 0.1510
q	 0.7000	 0.1510
z	 0.7200	 0.1470

