



Full wwPDB EM Validation Report ⓘ

Mar 8, 2026 – 03:37 AM UTC

PDB ID : 9CSA / pdb_00009csa
EMDB ID : EMD-45889
Title : TRiC-ATP-AIFx
Authors : Jin, M.; Cong, Y.
Deposited on : 2024-07-23
Resolution : 3.60 Å(reported)

This is a Full wwPDB EM Validation Report for a publicly released PDB entry.

We welcome your comments at validation@mail.wwpdb.org

A user guide is available at

<https://www.wwpdb.org/validation/2017/EMValidationReportHelp>

with specific help available everywhere you see the ⓘ symbol.

The types of validation reports are described at

<http://www.wwpdb.org/validation/2017/FAQs#types>.

The following versions of software and data (see [references ⓘ](#)) were used in the production of this report:

EMDB validation analysis : 0.0.1.dev132
MolProbity : 4-5-2 with Phenix2.0
Percentile statistics : 20250101.v01 (using entries in the PDB archive January 1st 2025)
EM percentile statistics : 202505.v01 (Using data in the EMDB archive up until May 2025)
MapQ : 1.9.13
Ideal geometry (proteins) : Engh & Huber (2001)
Ideal geometry (DNA, RNA) : Parkinson et al. (1996)
Validation Pipeline (wwPDB-VP) : 2.49

1 Overall quality at a glance

The following experimental techniques were used to determine the structure:
ELECTRON MICROSCOPY

The reported resolution of this entry is 3.60 Å.

Percentile scores (ranging between 0-100) for global validation metrics of the entry are shown in the following graphic. The table shows the number of entries on which the scores are based.

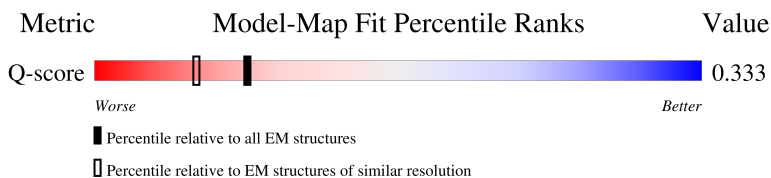
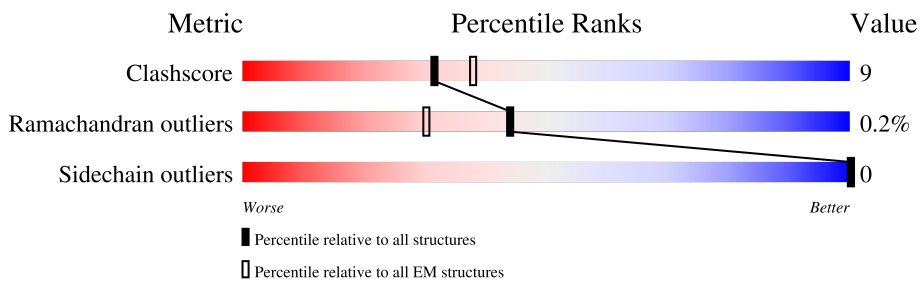

Metric	Whole archive (#Entries)	EM structures (#Entries)	Similar EM resolution (#Entries, resolution range(Å))
Clashscore	229148	23984	-
Ramachandran outliers	224038	23583	-
Sidechain outliers	223484	23102	-
Q-score	-	25397	12797 (3.10 - 4.10)

The table below summarises the geometric issues observed across the polymeric chains and their fit to the map. The red, orange, yellow and green segments of the bar indicate the fraction of residues that contain outliers for ≥ 3 , 2, 1 and 0 types of geometric quality criteria respectively. A grey segment represents the fraction of residues that are not modelled. The numeric value for each fraction is indicated below the corresponding segment, with a dot representing fractions $\leq 5\%$. The upper red bar (where present) indicates the fraction of residues that have poor fit to the EM map (all-atom inclusion $< 40\%$). The numeric value is given above the bar.

Mol	Chain	Length	Quality of chain
1	A	559	19% (red), 75% (green), 23% (yellow), 1% (grey)
1	a	559	18% (red), 77% (green), 21% (yellow), 1% (grey)
2	B	527	11% (red), 74% (green), 24% (yellow), 1% (grey)
2	b	527	12% (red), 78% (green), 20% (yellow), 1% (grey)

Continued on next page...

Continued from previous page...

Mol	Chain	Length	Quality of chain
3	D	528	
3	d	528	
4	E	562	
4	e	562	
5	G	594	
5	g	594	
6	H	550	
6	h	550	
7	Q	568	
7	q	568	
8	Z	546	
8	z	546	

2 Entry composition [i](#)

There are 8 unique types of molecules in this entry. The entry contains 64996 atoms, of which 0 are hydrogens and 0 are deuteriums.

In the tables below, the AltConf column contains the number of residues with at least one atom in alternate conformation and the Trace column contains the number of residues modelled with at most 2 atoms.

- Molecule 1 is a protein called T-complex protein 1 subunit alpha.

Mol	Chain	Residues	Atoms					AltConf	Trace
			Total	C	N	O	S		
1	a	546	Total	C	N	O	S	0	0
			4129	2582	721	806	20		
1	A	550	Total	C	N	O	S	0	0
			4158	2599	725	813	21		

- Molecule 2 is a protein called T-complex protein 1 subunit beta.

Mol	Chain	Residues	Atoms					AltConf	Trace
			Total	C	N	O	S		
2	b	518	Total	C	N	O	S	0	0
			3937	2461	680	782	14		
2	B	518	Total	C	N	O	S	0	0
			3937	2461	680	782	14		

- Molecule 3 is a protein called T-complex protein 1 subunit delta.

Mol	Chain	Residues	Atoms					AltConf	Trace
			Total	C	N	O	S		
3	d	524	Total	C	N	O	S	0	0
			4005	2497	712	779	17		
3	D	523	Total	C	N	O	S	0	0
			3998	2492	711	778	17		

- Molecule 4 is a protein called T-complex protein 1 subunit epsilon.

Mol	Chain	Residues	Atoms					AltConf	Trace
			Total	C	N	O	S		
4	e	535	Total	C	N	O	S	0	0
			4124	2590	709	803	22		
4	E	536	Total	C	N	O	S	0	0
			4133	2595	710	806	22		

- Molecule 5 is a protein called T-complex protein 1 subunit gamma.

Mol	Chain	Residues	Atoms					AltConf	Trace
5	g	520	Total 4003	C 2511	N 703	O 762	S 27	0	0
5	G	520	Total 4004	C 2510	N 703	O 764	S 27	0	0

There are 120 discrepancies between the modelled and reference sequences:

Chain	Residue	Modelled	Actual	Comment	Reference
g	375	LEU	-	insertion	UNP P39077
g	376	GLU	-	insertion	UNP P39077
g	377	GLY	-	insertion	UNP P39077
g	378	SER	-	insertion	UNP P39077
g	379	GLY	-	insertion	UNP P39077
g	380	SER	-	insertion	UNP P39077
g	381	GLY	-	insertion	UNP P39077
g	382	TRP	-	insertion	UNP P39077
g	383	SER	-	insertion	UNP P39077
g	384	HIS	-	insertion	UNP P39077
g	385	PRO	-	insertion	UNP P39077
g	386	GLN	-	insertion	UNP P39077
g	387	PHE	-	insertion	UNP P39077
g	388	GLU	-	insertion	UNP P39077
g	389	LYS	-	insertion	UNP P39077
g	390	GLY	-	insertion	UNP P39077
g	391	SER	-	insertion	UNP P39077
g	392	GLY	-	insertion	UNP P39077
g	393	LYS	-	insertion	UNP P39077
g	394	ARG	-	insertion	UNP P39077
g	395	ARG	-	insertion	UNP P39077
g	396	TRP	-	insertion	UNP P39077
g	397	LYS	-	insertion	UNP P39077
g	398	LYS	-	insertion	UNP P39077
g	399	ASN	-	insertion	UNP P39077
g	400	PHE	-	insertion	UNP P39077
g	401	ILE	-	insertion	UNP P39077
g	402	ALA	-	insertion	UNP P39077
g	403	VAL	-	insertion	UNP P39077
g	404	SER	-	insertion	UNP P39077
g	405	ALA	-	insertion	UNP P39077
g	406	ALA	-	insertion	UNP P39077
g	407	ASN	-	insertion	UNP P39077
g	408	ARG	-	insertion	UNP P39077
g	409	PHE	-	insertion	UNP P39077

Continued on next page...

Continued from previous page...

Chain	Residue	Modelled	Actual	Comment	Reference
g	410	LYS	-	insertion	UNP P39077
g	411	LYS	-	insertion	UNP P39077
g	412	ILE	-	insertion	UNP P39077
g	413	SER	-	insertion	UNP P39077
g	414	SER	-	insertion	UNP P39077
g	415	SER	-	insertion	UNP P39077
g	416	GLY	-	insertion	UNP P39077
g	417	ALA	-	insertion	UNP P39077
g	418	LEU	-	insertion	UNP P39077
g	419	GLY	-	insertion	UNP P39077
g	420	SER	-	insertion	UNP P39077
g	421	GLY	-	insertion	UNP P39077
g	422	HIS	-	insertion	UNP P39077
g	423	HIS	-	insertion	UNP P39077
g	424	HIS	-	insertion	UNP P39077
g	425	HIS	-	insertion	UNP P39077
g	426	HIS	-	insertion	UNP P39077
g	427	HIS	-	insertion	UNP P39077
g	428	HIS	-	insertion	UNP P39077
g	429	HIS	-	insertion	UNP P39077
g	430	GLY	-	insertion	UNP P39077
g	431	SER	-	insertion	UNP P39077
g	432	GLY	-	insertion	UNP P39077
g	433	LEU	-	insertion	UNP P39077
g	434	GLN	-	insertion	UNP P39077
G	375	LEU	-	insertion	UNP P39077
G	376	GLU	-	insertion	UNP P39077
G	377	GLY	-	insertion	UNP P39077
G	378	SER	-	insertion	UNP P39077
G	379	GLY	-	insertion	UNP P39077
G	380	SER	-	insertion	UNP P39077
G	381	GLY	-	insertion	UNP P39077
G	382	TRP	-	insertion	UNP P39077
G	383	SER	-	insertion	UNP P39077
G	384	HIS	-	insertion	UNP P39077
G	385	PRO	-	insertion	UNP P39077
G	386	GLN	-	insertion	UNP P39077
G	387	PHE	-	insertion	UNP P39077
G	388	GLU	-	insertion	UNP P39077
G	389	LYS	-	insertion	UNP P39077
G	390	GLY	-	insertion	UNP P39077
G	391	SER	-	insertion	UNP P39077

Continued on next page...

Continued from previous page...

Chain	Residue	Modelled	Actual	Comment	Reference
G	392	GLY	-	insertion	UNP P39077
G	393	LYS	-	insertion	UNP P39077
G	394	ARG	-	insertion	UNP P39077
G	395	ARG	-	insertion	UNP P39077
G	396	TRP	-	insertion	UNP P39077
G	397	LYS	-	insertion	UNP P39077
G	398	LYS	-	insertion	UNP P39077
G	399	ASN	-	insertion	UNP P39077
G	400	PHE	-	insertion	UNP P39077
G	401	ILE	-	insertion	UNP P39077
G	402	ALA	-	insertion	UNP P39077
G	403	VAL	-	insertion	UNP P39077
G	404	SER	-	insertion	UNP P39077
G	405	ALA	-	insertion	UNP P39077
G	406	ALA	-	insertion	UNP P39077
G	407	ASN	-	insertion	UNP P39077
G	408	ARG	-	insertion	UNP P39077
G	409	PHE	-	insertion	UNP P39077
G	410	LYS	-	insertion	UNP P39077
G	411	LYS	-	insertion	UNP P39077
G	412	ILE	-	insertion	UNP P39077
G	413	SER	-	insertion	UNP P39077
G	414	SER	-	insertion	UNP P39077
G	415	SER	-	insertion	UNP P39077
G	416	GLY	-	insertion	UNP P39077
G	417	ALA	-	insertion	UNP P39077
G	418	LEU	-	insertion	UNP P39077
G	419	GLY	-	insertion	UNP P39077
G	420	SER	-	insertion	UNP P39077
G	421	GLY	-	insertion	UNP P39077
G	422	HIS	-	insertion	UNP P39077
G	423	HIS	-	insertion	UNP P39077
G	424	HIS	-	insertion	UNP P39077
G	425	HIS	-	insertion	UNP P39077
G	426	HIS	-	insertion	UNP P39077
G	427	HIS	-	insertion	UNP P39077
G	428	HIS	-	insertion	UNP P39077
G	429	HIS	-	insertion	UNP P39077
G	430	GLY	-	insertion	UNP P39077
G	431	SER	-	insertion	UNP P39077
G	432	GLY	-	insertion	UNP P39077
G	433	LEU	-	insertion	UNP P39077

Continued on next page...

Continued from previous page...

Chain	Residue	Modelled	Actual	Comment	Reference
G	434	GLN	-	insertion	UNP P39077

- Molecule 6 is a protein called T-complex protein 1 subunit eta.

Mol	Chain	Residues	Atoms					AltConf	Trace
			Total	C	N	O	S		
6	h	527	4032	2540	688	784	20	0	0
6	H	520	3980	2510	678	773	19	0	0

- Molecule 7 is a protein called T-complex protein 1 subunit theta.

Mol	Chain	Residues	Atoms					AltConf	Trace
			Total	C	N	O	S		
7	q	541	4115	2592	703	794	26	0	0
7	Q	548	4163	2622	711	804	26	0	0

- Molecule 8 is a protein called T-complex protein 1 subunit zeta.

Mol	Chain	Residues	Atoms					AltConf	Trace
			Total	C	N	O	S		
8	z	538	4139	2599	717	806	17	0	0
8	Z	538	4139	2599	717	806	17	0	0

3 Residue-property plots [i](#)

These plots are drawn for all protein, RNA, DNA and oligosaccharide chains in the entry. The first graphic for a chain summarises the proportions of the various outlier classes displayed in the second graphic. The second graphic shows the sequence view annotated by issues in geometry and atom inclusion in map density. Residues are color-coded according to the number of geometric quality criteria for which they contain at least one outlier: green = 0, yellow = 1, orange = 2 and red = 3 or more. A red diamond above a residue indicates a poor fit to the EM map for this residue (all-atom inclusion < 40%). Stretches of 2 or more consecutive residues without any outlier are shown as a green connector. Residues present in the sample, but not in the model, are shown in grey.

- Molecule 1: T-complex protein 1 subunit alpha

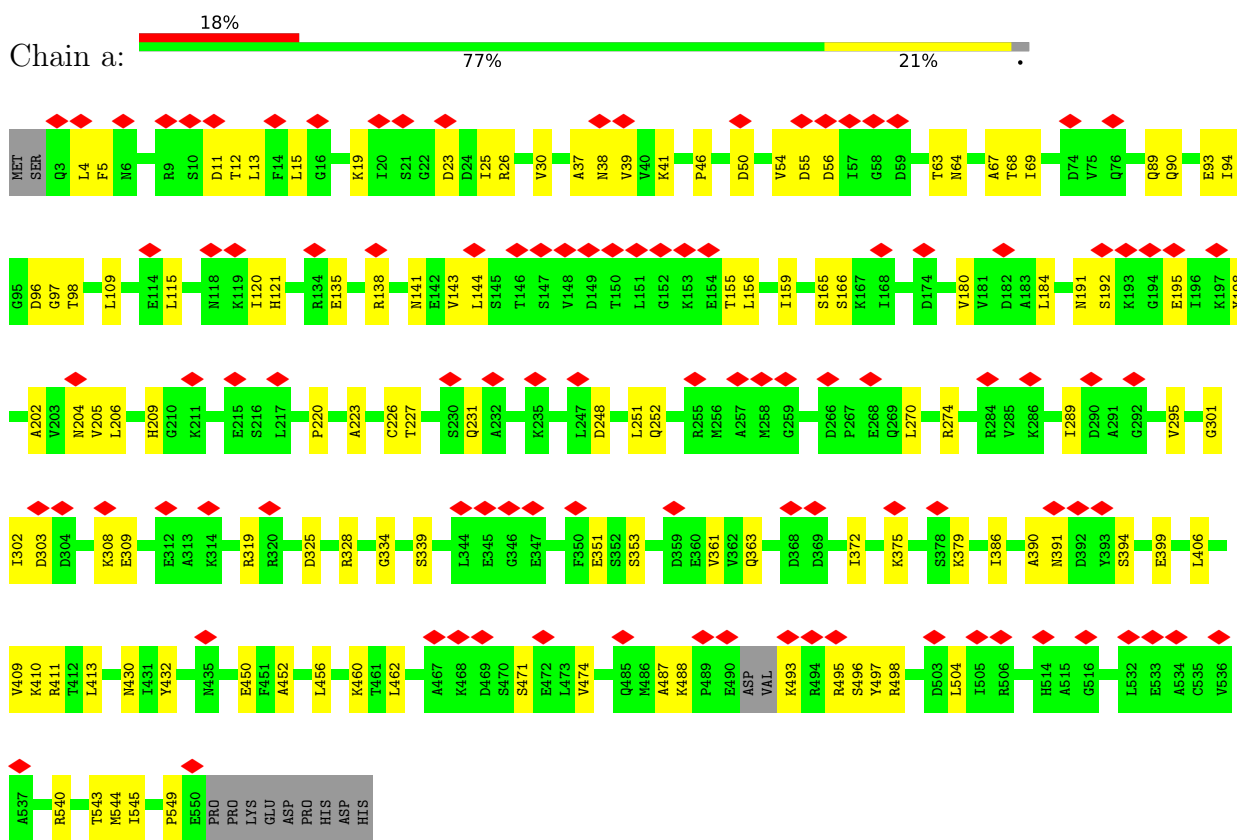

- Molecule 1: T-complex protein 1 subunit alpha

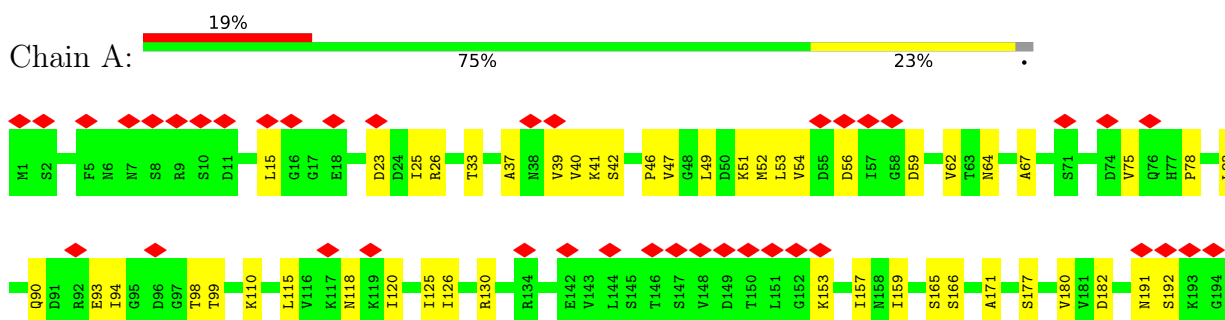

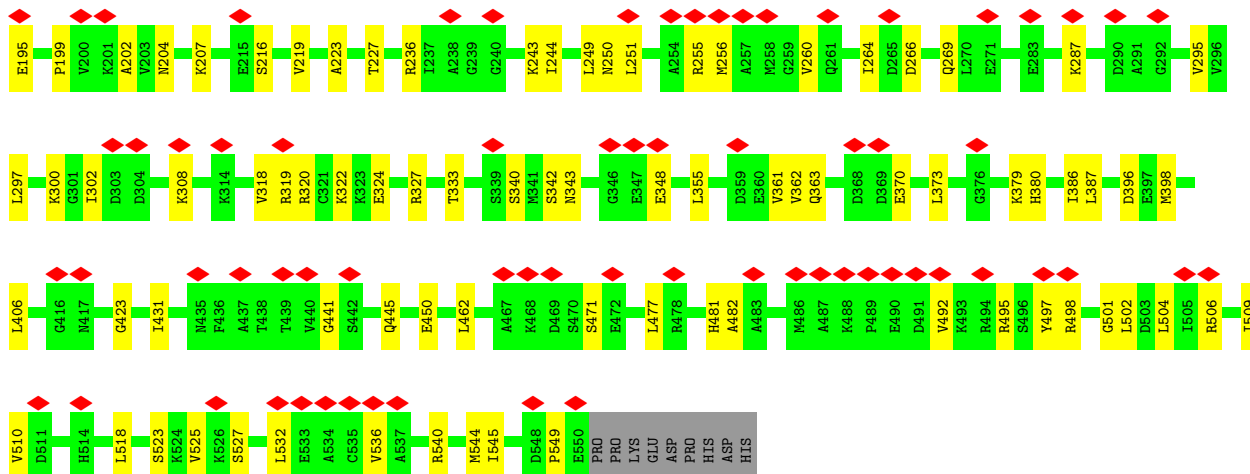

• Molecule 2: T-complex protein 1 subunit beta

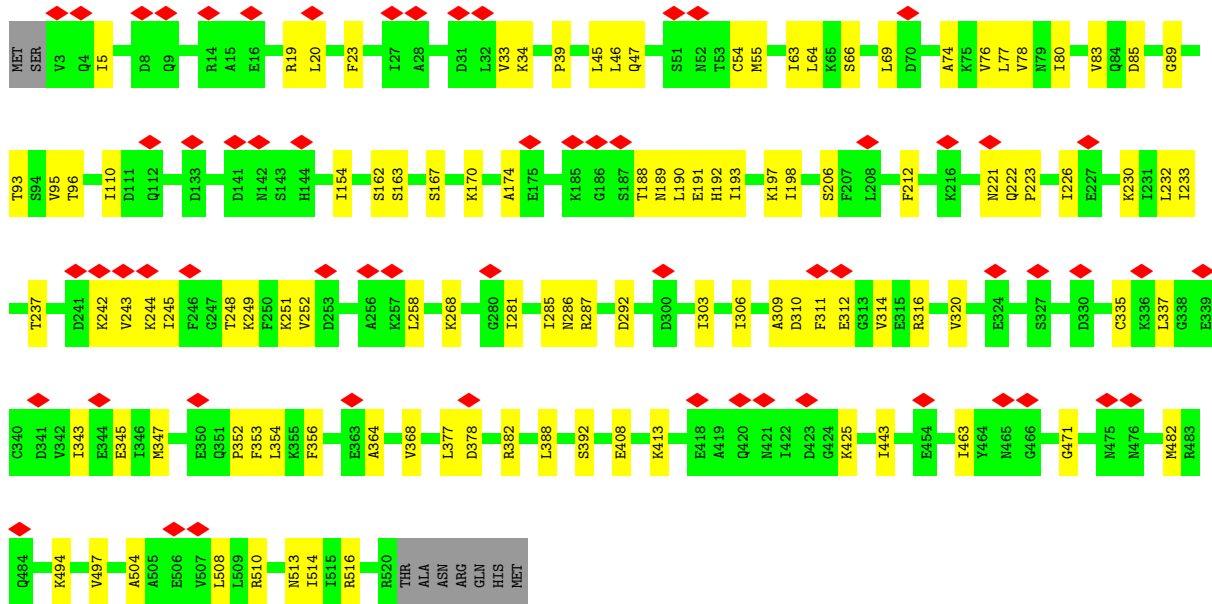
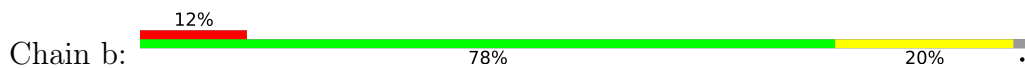

• Molecule 2: T-complex protein 1 subunit beta

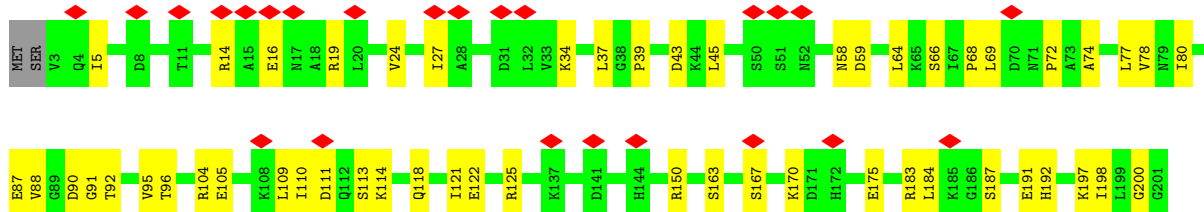
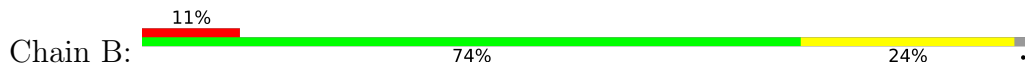

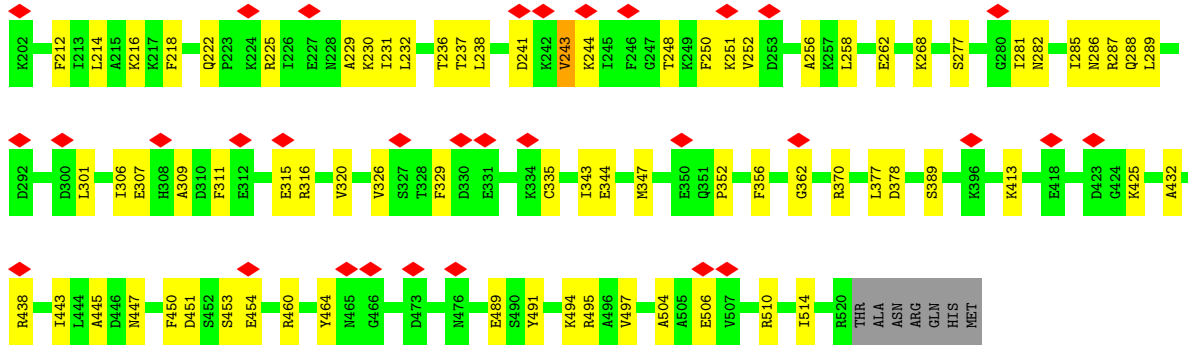

• Molecule 3: T-complex protein 1 subunit delta

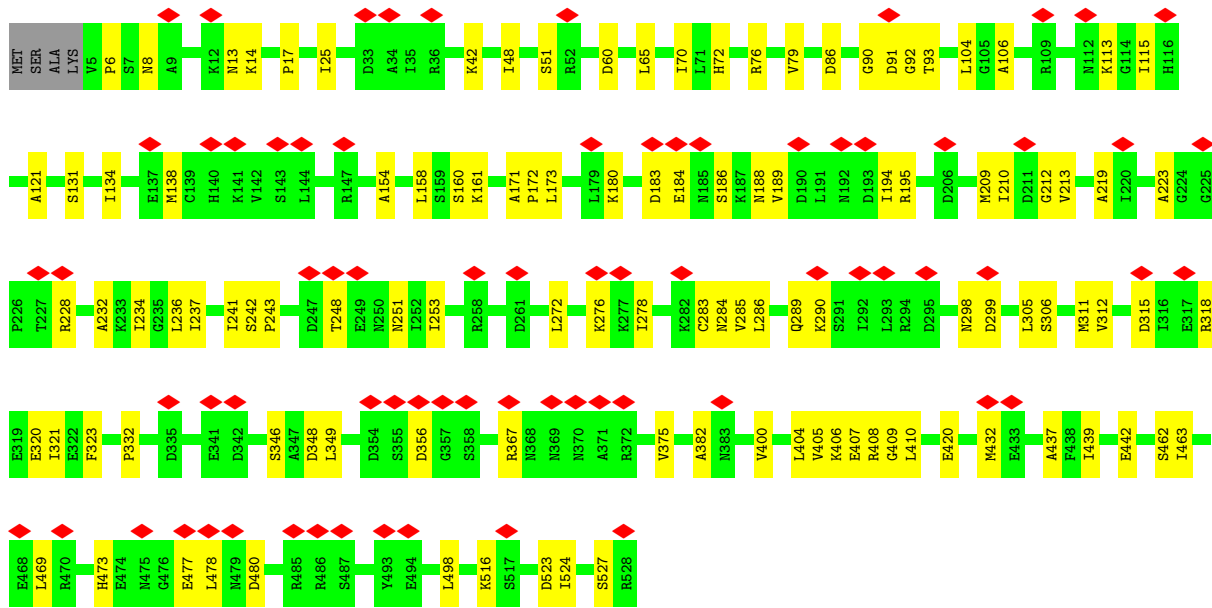
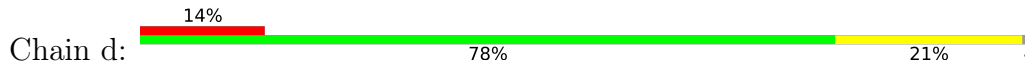

• Molecule 3: T-complex protein 1 subunit delta

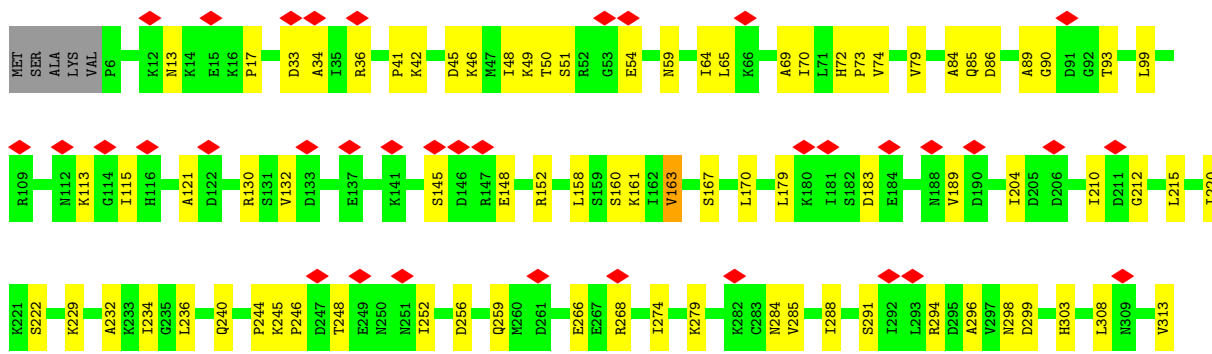
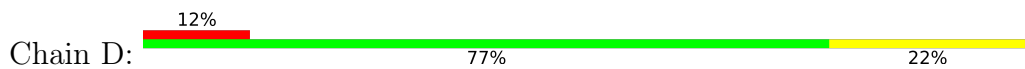

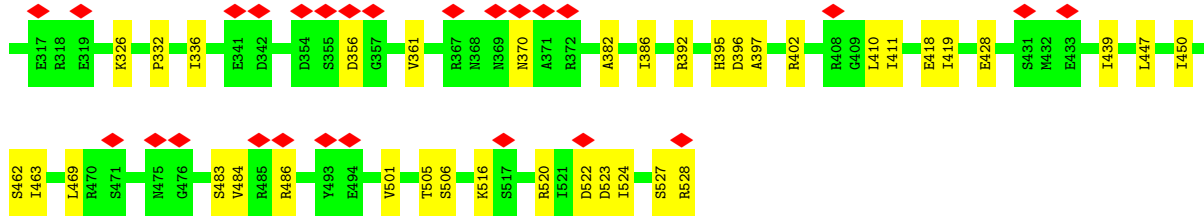

• Molecule 4: T-complex protein 1 subunit epsilon

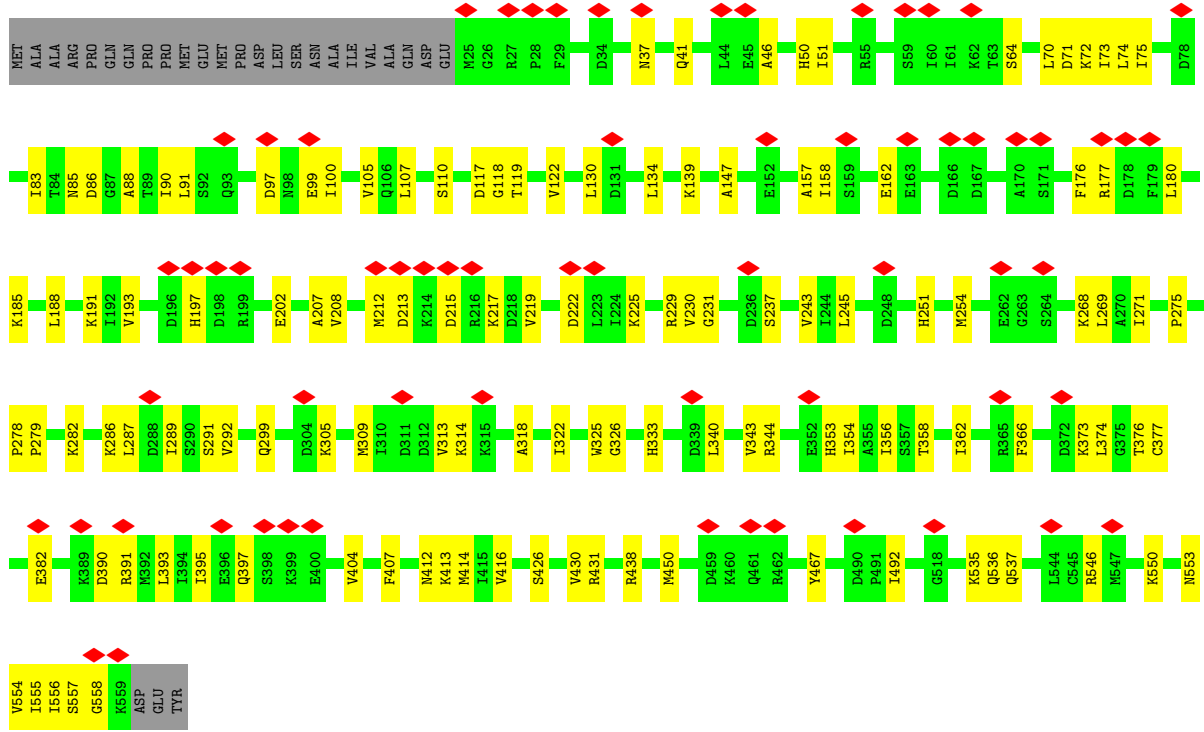

• Molecule 4: T-complex protein 1 subunit epsilon

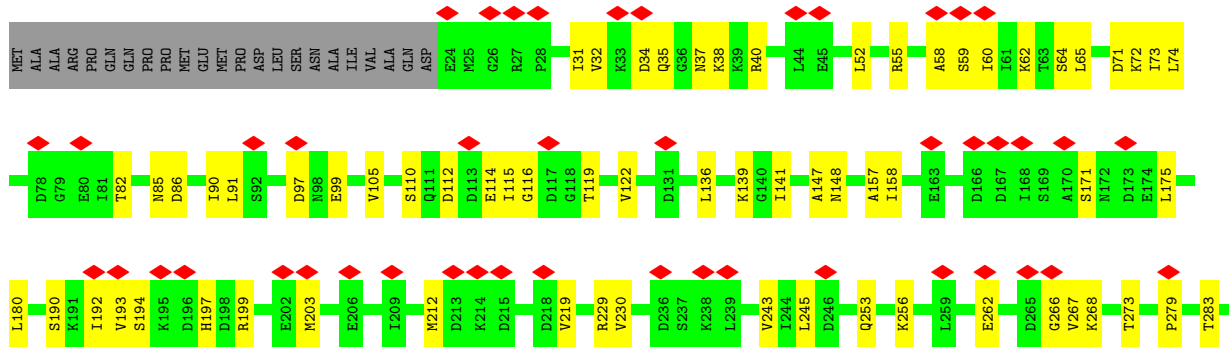
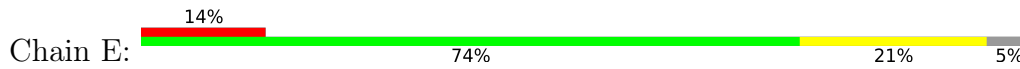

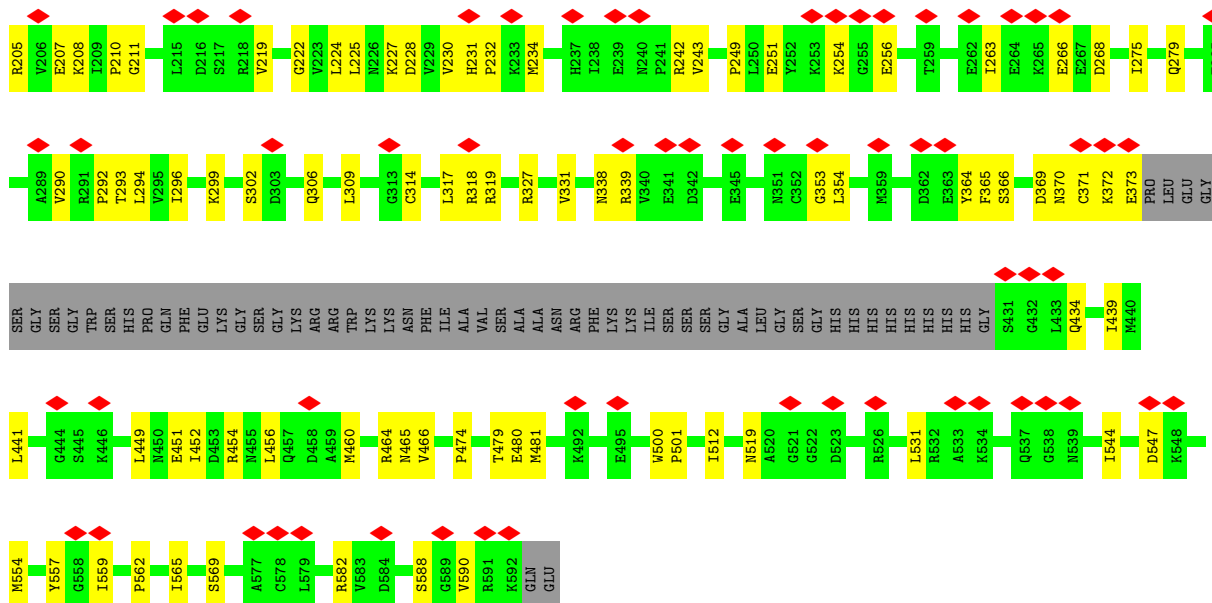

• Molecule 6: T-complex protein 1 subunit eta

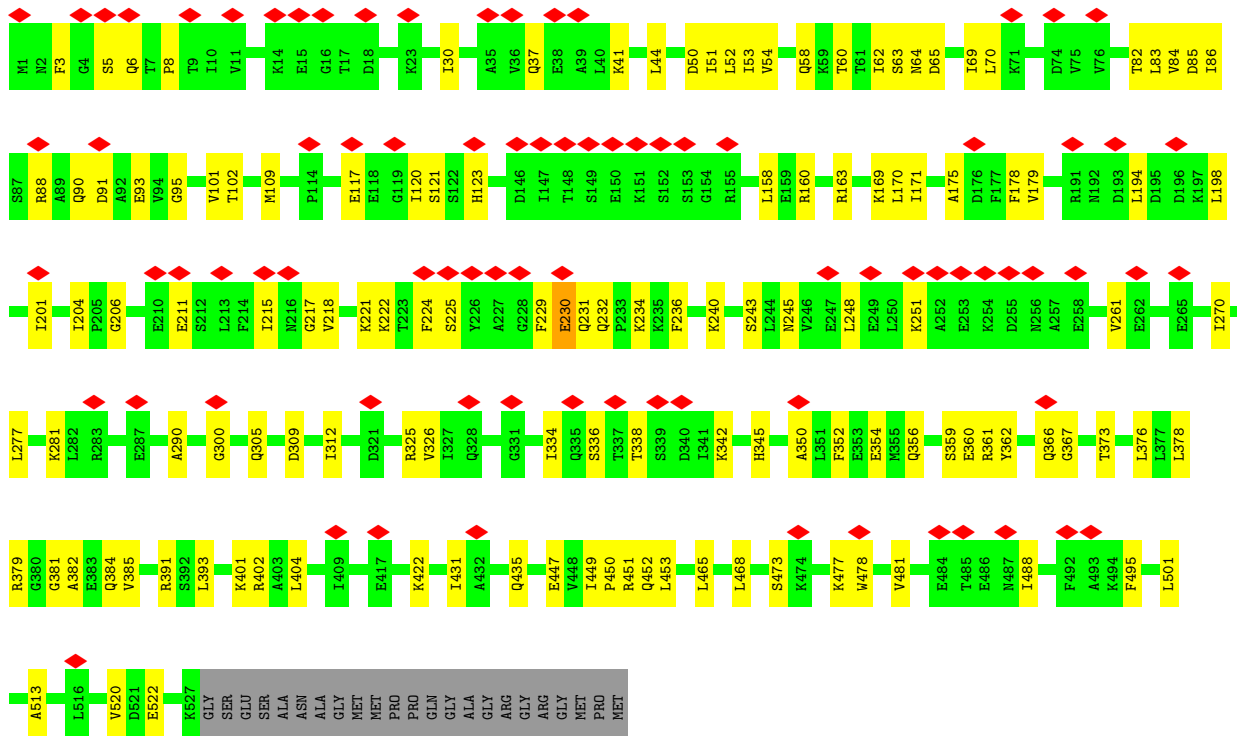
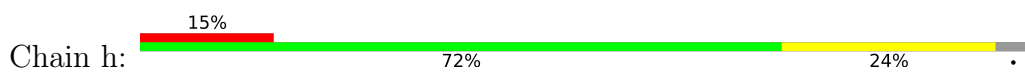

• Molecule 6: T-complex protein 1 subunit eta



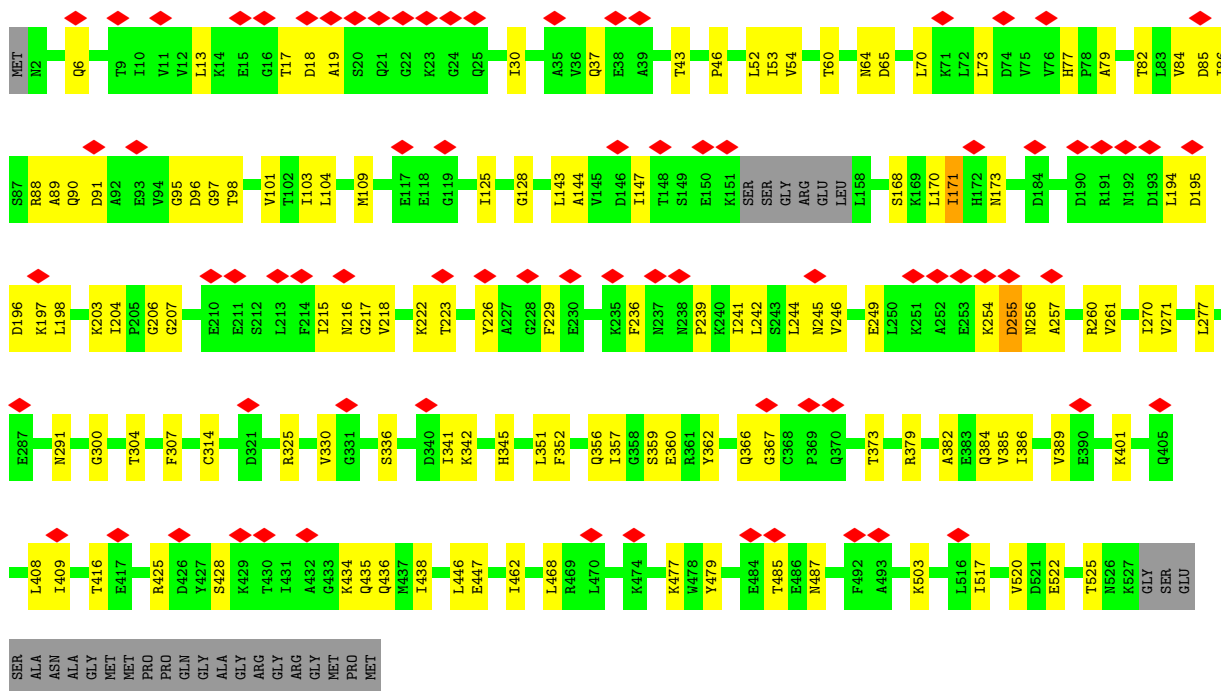

• Molecule 7: T-complex protein 1 subunit theta

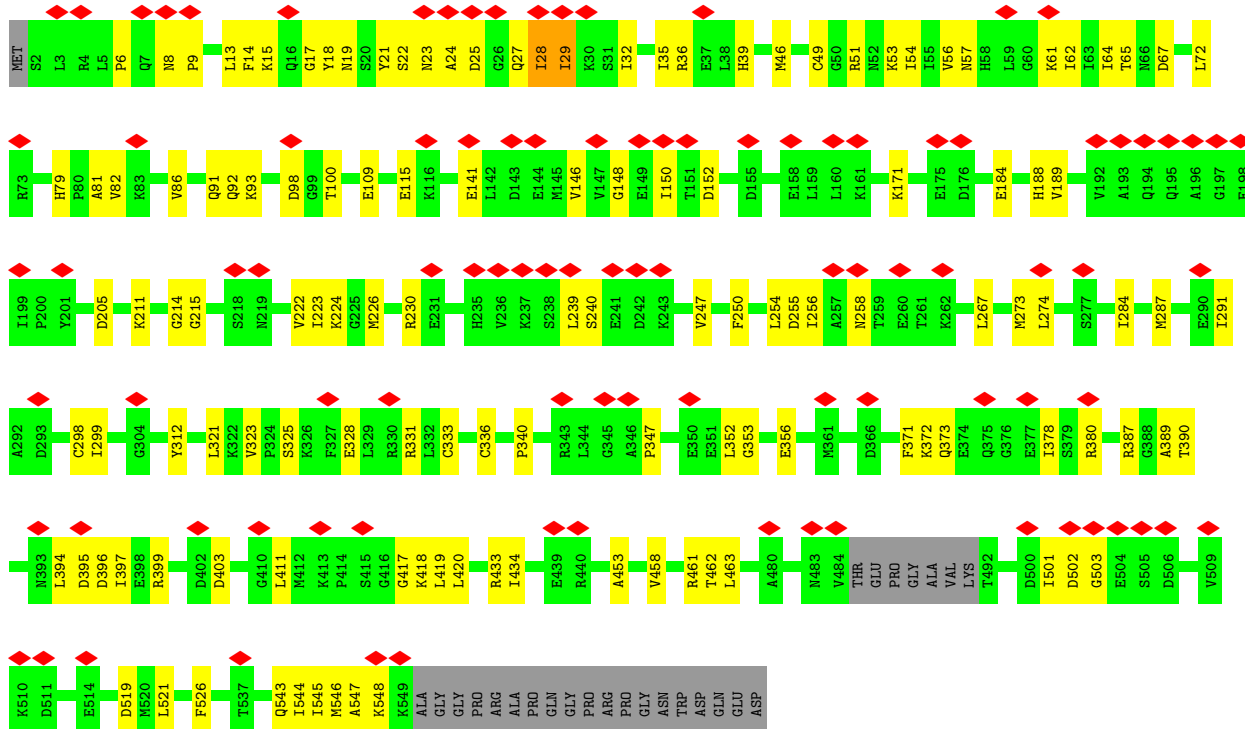

• Molecule 7: T-complex protein 1 subunit theta

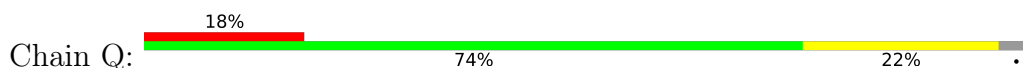

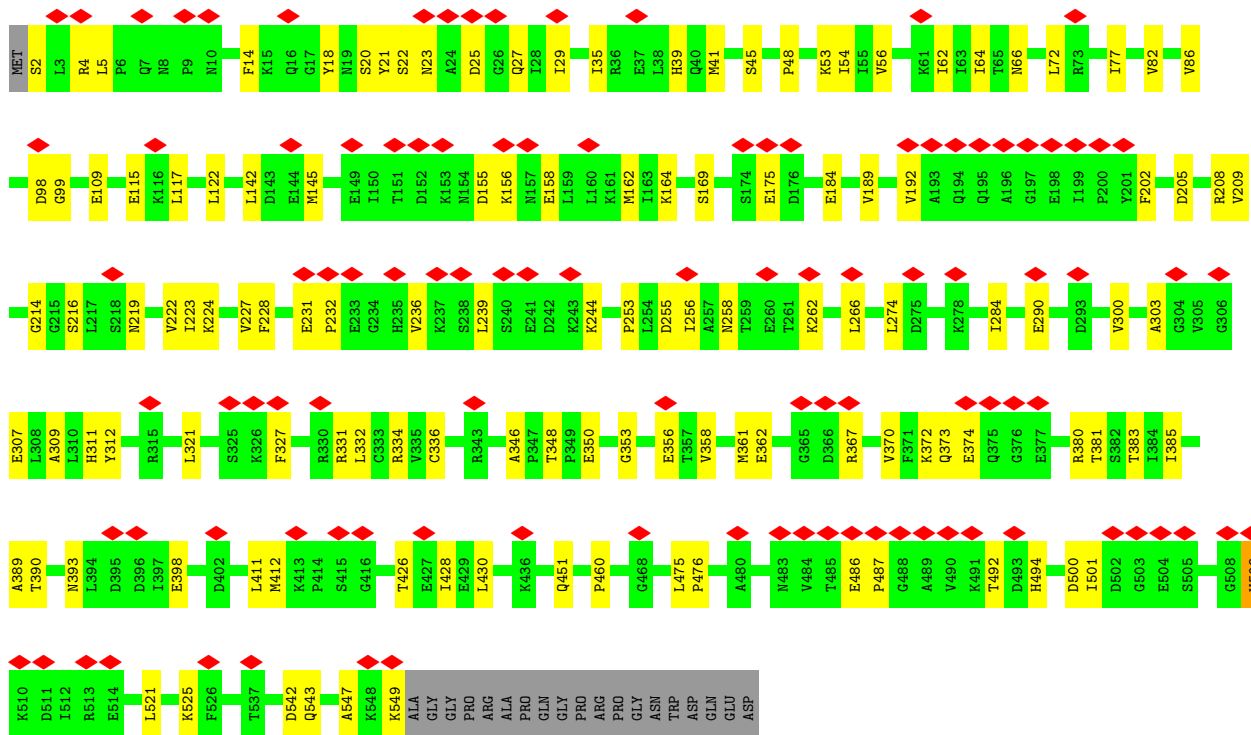

• Molecule 8: T-complex protein 1 subunit zeta

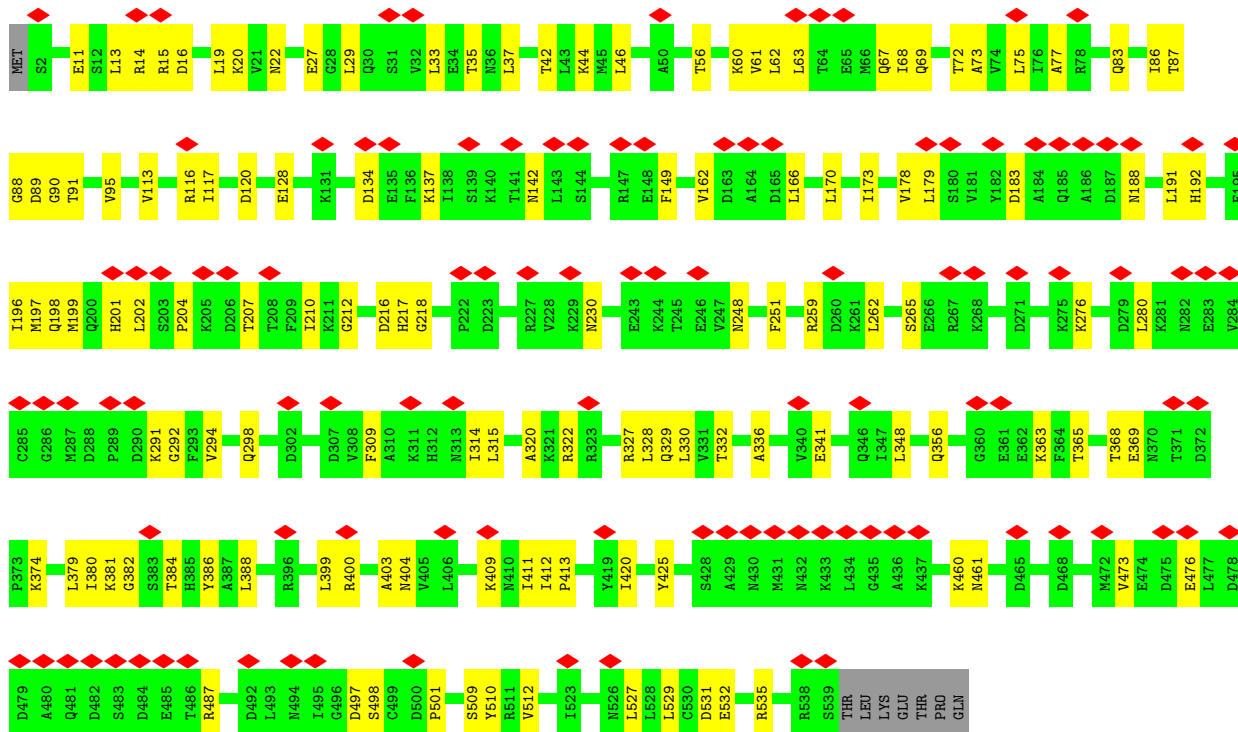
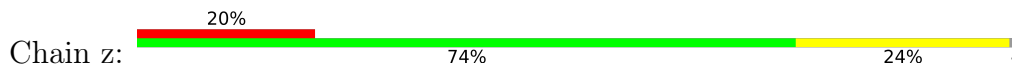

• Molecule 8: T-complex protein 1 subunit zeta

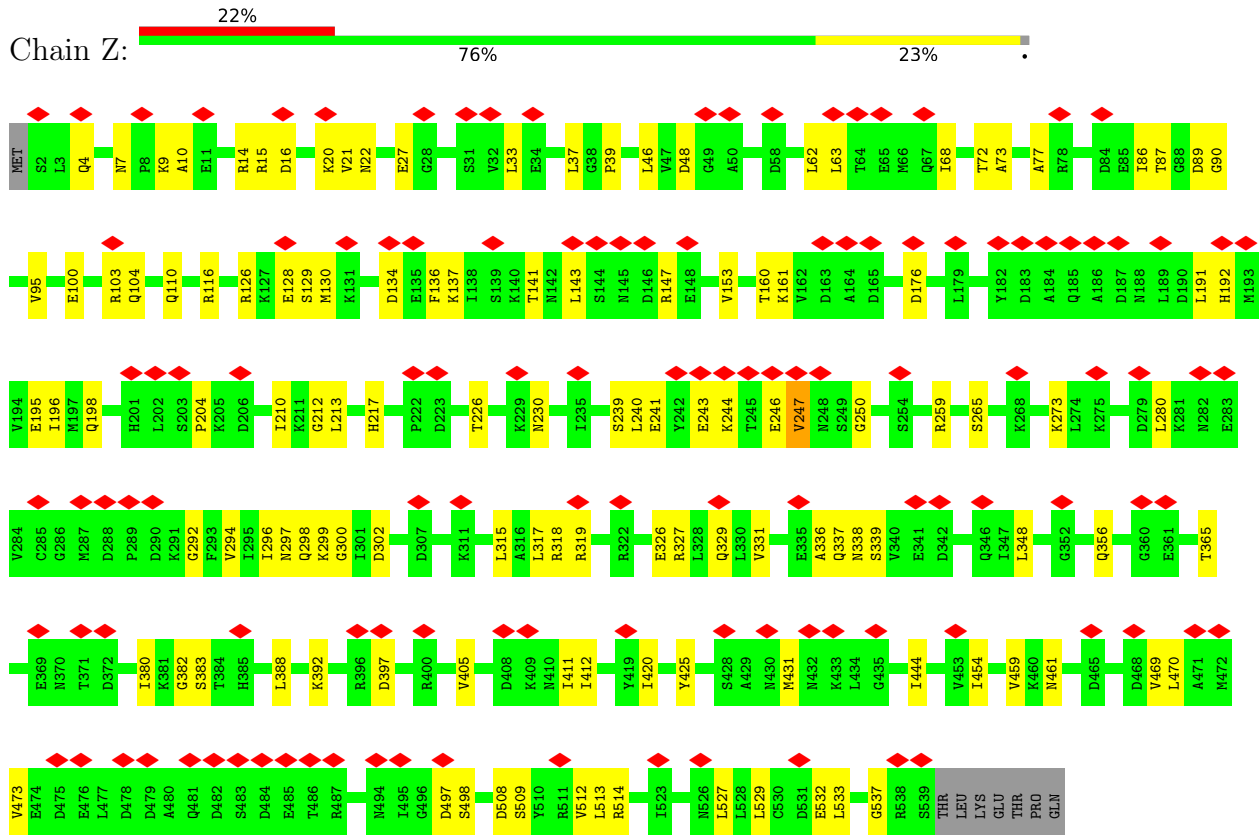

4 Experimental information

Property	Value	Source
EM reconstruction method	SINGLE PARTICLE	Depositor
Imposed symmetry	POINT, Not provided	
Number of particles used	290160	Depositor
Resolution determination method	FSC 0.143 CUT-OFF	Depositor
CTF correction method	NONE	Depositor
Microscope	FEI TITAN KRIOS	Depositor
Voltage (kV)	300	Depositor
Electron dose ($e^-/\text{\AA}^2$)	38	Depositor
Minimum defocus (nm)	1200	Depositor
Maximum defocus (nm)	2400	Depositor
Magnification	Not provided	
Image detector	GATAN K2 SUMMIT (4k x 4k)	Depositor
Maximum map value	0.121	Depositor
Minimum map value	-0.077	Depositor
Average map value	0.000	Depositor
Map value standard deviation	0.004	Depositor
Recommended contour level	0.015	Depositor
Map size (\AA)	337.408, 337.408, 337.408	wwPDB
Map dimensions	256, 256, 256	wwPDB
Map angles ($^\circ$)	90.0, 90.0, 90.0	wwPDB
Pixel spacing (\AA)	1.318, 1.318, 1.318	Depositor

5 Model quality [i](#)

5.1 Standard geometry [i](#)

The Z score for a bond length (or angle) is the number of standard deviations the observed value is removed from the expected value. A bond length (or angle) with $|Z| > 5$ is considered an outlier worth inspection. RMSZ is the root-mean-square of all Z scores of the bond lengths (or angles).

Mol	Chain	Bond lengths		Bond angles	
		RMSZ	# Z >5	RMSZ	# Z >5
1	A	0.08	0/4196	0.27	0/5661
1	a	0.08	0/4166	0.26	0/5619
2	B	0.07	0/3976	0.24	0/5358
2	b	0.07	0/3976	0.24	0/5358
3	D	0.08	0/4036	0.24	0/5440
3	d	0.08	0/4043	0.24	0/5451
4	E	0.07	0/4184	0.23	0/5629
4	e	0.07	0/4175	0.23	0/5617
5	G	0.08	0/4048	0.26	0/5459
5	g	0.08	0/4047	0.23	0/5460
6	H	0.08	0/4030	0.27	0/5440
6	h	0.08	0/4083	0.25	0/5511
7	Q	0.09	0/4214	0.28	0/5689
7	q	0.08	0/4164	0.25	0/5619
8	Z	0.08	0/4191	0.24	0/5663
8	z	0.07	0/4191	0.23	0/5663
All	All	0.08	0/65720	0.25	0/88637

There are no bond length outliers.

There are no bond angle outliers.

There are no chirality outliers.

There are no planarity outliers.

5.2 Too-close contacts [i](#)

In the following table, the Non-H and H(model) columns list the number of non-hydrogen atoms and hydrogen atoms in the chain respectively. The H(added) column lists the number of hydrogen atoms added and optimized by MolProbity. The Clashes column lists the number of clashes within the asymmetric unit, whereas Symm-Clashes lists symmetry-related clashes.

Mol	Chain	Non-H	H(model)	H(added)	Clashes	Symm-Clashes
1	A	4158	0	4322	86	0
1	a	4129	0	4291	78	0
2	B	3937	0	4043	87	0
2	b	3937	0	4043	75	0
3	D	3998	0	4170	79	0
3	d	4005	0	4178	70	0
4	E	4133	0	4237	86	0
4	e	4124	0	4231	89	0
5	G	4004	0	4152	90	0
5	g	4003	0	4154	71	0
6	H	3980	0	4060	91	0
6	h	4032	0	4116	94	0
7	Q	4163	0	4300	81	0
7	q	4115	0	4249	91	0
8	Z	4139	0	4233	83	0
8	z	4139	0	4233	83	0
All	All	64996	0	67012	1149	0

The all-atom clashscore is defined as the number of clashes found per 1000 atoms (including hydrogen atoms). The all-atom clashscore for this structure is 9.

All (1149) close contacts within the same asymmetric unit are listed below, sorted by their clash magnitude.

Atom-1	Atom-2	Interatomic distance (Å)	Clash overlap (Å)
8:z:329:GLN:HE21	8:z:336:ALA:H	1.31	0.78
1:a:540:ARG:NH2	3:d:160:SER:O	2.19	0.75
1:a:63:THR:HG21	1:a:68:THR:HB	1.71	0.72
7:q:239:LEU:HD23	7:q:240:SER:H	1.54	0.71
8:Z:195:GLU:HB3	8:Z:327:ARG:HH22	1.53	0.71
5:G:159:ILE:HG23	5:G:164:VAL:HG23	1.73	0.71
7:Q:4:ARG:HB3	8:z:69:GLN:HE21	1.56	0.71
1:a:471:SER:OG	6:H:434:LYS:NZ	2.23	0.71
7:Q:262:LYS:HB3	8:Z:250:GLY:HA3	1.73	0.70
2:b:232:LEU:HD12	2:b:337:LEU:HD11	1.73	0.70
4:E:243:VAL:HG21	4:E:354:ILE:HA	1.74	0.69
1:A:250:ASN:HB3	1:A:300:LYS:HB2	1.74	0.69
7:q:226:MET:H	7:q:371:PHE:HB2	1.57	0.69
8:Z:296:ILE:HG12	8:Z:317:LEU:HD12	1.74	0.69
1:A:431:ILE:HG21	1:A:482:ALA:HA	1.74	0.69
1:a:54:VAL:HG12	1:a:56:ASP:H	1.58	0.68
3:d:65:LEU:HB3	3:d:79:VAL:HG22	1.75	0.68
6:H:64:ASN:ND2	6:H:168:SER:O	2.26	0.68

Continued on next page...

Continued from previous page...

Atom-1	Atom-2	Interatomic distance (Å)	Clash overlap (Å)
5:G:201:LYS:HE2	5:G:464:ARG:HD2	1.76	0.68
5:g:200:ILE:HG22	5:g:202:ARG:H	1.59	0.68
6:h:91:ASP:HA	6:h:95:GLY:HA2	1.77	0.67
4:e:326:GLY:HA2	4:e:344:ARG:HB2	1.77	0.67
3:D:65:LEU:HB3	3:D:79:VAL:HG22	1.77	0.67
5:g:159:ILE:HG23	5:g:164:VAL:HG23	1.77	0.67
6:H:128:GLY:HA2	6:H:435:GLN:HE21	1.60	0.67
2:B:64:LEU:HB3	2:B:78:VAL:HG22	1.77	0.67
6:h:201:ILE:HG12	6:h:376:LEU:HB2	1.77	0.66
3:d:405:VAL:O	3:d:408:ARG:NH2	2.28	0.66
4:E:194:SER:O	4:E:197:HIS:ND1	2.28	0.66
1:A:297:LEU:HD23	1:A:318:VAL:HG21	1.77	0.66
3:d:477:GLU:HG2	3:d:478:LEU:HG	1.76	0.66
5:G:99:LEU:HB2	5:G:512:ILE:HD11	1.78	0.66
3:d:286:LEU:HB2	3:d:312:VAL:HG22	1.78	0.66
4:e:275:PRO:HG3	4:e:325:TRP:HB2	1.75	0.66
4:E:230:VAL:HA	4:E:416:VAL:HG21	1.77	0.66
6:h:221:LYS:HG2	6:h:222:LYS:H	1.60	0.66
5:g:48:LEU:HD11	5:g:64:ILE:HA	1.78	0.65
8:z:178:VAL:HG13	8:z:179:LEU:H	1.60	0.65
8:Z:198:GLN:HB2	8:Z:388:LEU:HD13	1.78	0.65
6:H:522:GLU:HB3	7:Q:53:LYS:HD2	1.79	0.65
8:z:196:ILE:HG23	8:z:380:ILE:HD12	1.79	0.65
4:e:73:ILE:HG12	4:e:83:ILE:HG12	1.78	0.65
7:q:21:TYR:HB2	7:q:544:ILE:HB	1.79	0.65
8:z:251:PHE:HB3	8:z:262:LEU:HD13	1.79	0.65
2:b:64:LEU:HB3	2:b:78:VAL:HG22	1.77	0.65
7:Q:21:TYR:HB3	7:Q:27:GLN:HG2	1.77	0.65
1:a:274:ARG:NH1	5:g:253:LYS:O	2.30	0.65
6:H:226:TYR:HB2	6:H:229:PHE:HB2	1.79	0.65
1:a:191:ASN:OD1	1:a:192:SER:N	2.30	0.64
6:h:240:LYS:HB2	6:h:290:ALA:HA	1.79	0.64
2:b:188:THR:HG23	2:b:392:SER:HB2	1.80	0.64
6:H:203:LYS:HB3	6:H:386:ILE:HD12	1.78	0.64
2:b:425:LYS:NZ	2:B:453:SER:OG	2.31	0.64
4:E:85:ASN:ND2	4:E:190:SER:O	2.31	0.64
6:H:356:GLN:HE21	6:H:359:SER:HA	1.61	0.64
7:Q:54:ILE:HG12	7:Q:64:ILE:HG12	1.79	0.64
5:G:41:PRO:O	8:Z:116:ARG:NH1	2.32	0.63
7:Q:41:MET:O	7:Q:53:LYS:NZ	2.30	0.63
6:H:239:PRO:HA	6:H:291:ASN:HD22	1.63	0.63

Continued on next page...

Continued from previous page...

Atom-1	Atom-2	Interatomic distance (Å)	Clash overlap (Å)
4:E:199:ARG:HG2	4:E:203:MET:HE2	1.81	0.63
1:a:93:GLU:O	1:a:411:ARG:NH2	2.31	0.63
5:g:298:GLU:HB3	5:g:325:ASN:HD21	1.64	0.63
7:Q:334:ARG:HE	7:Q:380:ARG:HH12	1.47	0.63
6:H:215:ILE:HG22	6:H:217:GLY:H	1.64	0.62
1:A:191:ASN:OD1	1:A:192:SER:N	2.30	0.62
1:A:256:MET:HE2	1:A:260:VAL:HG21	1.80	0.62
6:H:60:THR:O	6:H:384:GLN:NE2	2.32	0.62
7:q:6:PRO:HG2	8:Z:21:VAL:HG13	1.80	0.62
4:e:268:LYS:HB3	4:e:374:LEU:HD13	1.81	0.62
7:q:291:ILE:HG21	7:q:299:ILE:HD11	1.81	0.62
8:z:191:LEU:HD11	8:z:403:ALA:HB2	1.82	0.62
8:Z:300:GLY:HA2	8:Z:318:ARG:HB2	1.81	0.62
5:g:207:GLU:HG2	5:g:224:LEU:HD23	1.82	0.62
1:a:121:HIS:NE2	3:d:42:LYS:O	2.29	0.62
8:Z:191:LEU:O	8:Z:327:ARG:NH1	2.32	0.62
4:e:91:LEU:HB3	4:e:105:VAL:HG22	1.80	0.62
5:G:114:LYS:HD3	7:q:461:ARG:HH12	1.64	0.62
3:d:228:ARG:HE	3:d:349:LEU:HD11	1.64	0.61
7:Q:208:ARG:HB3	7:Q:383:THR:HG22	1.82	0.61
1:A:204:ASN:ND2	1:A:223:ALA:O	2.31	0.61
2:B:45:LEU:HD23	3:D:524:ILE:HG12	1.82	0.61
4:e:222:ASP:O	4:e:225:LYS:NZ	2.33	0.61
3:D:220:ILE:HG22	3:D:222:SER:H	1.65	0.61
5:g:126:LYS:NZ	5:g:575:GLU:OE2	2.33	0.61
6:H:382:ALA:HB3	6:H:385:VAL:HG23	1.81	0.61
2:B:287:ARG:HA	2:B:309:ALA:HB3	1.82	0.61
4:e:322:ILE:HG22	4:e:343:VAL:HB	1.81	0.61
8:z:191:LEU:HD13	8:z:399:LEU:HB3	1.83	0.61
2:b:197:LYS:HB3	2:b:377:LEU:HD13	1.82	0.61
1:a:13:LEU:HD21	1:a:19:LYS:HD3	1.83	0.61
1:a:325:ASP:OD1	1:a:328:ARG:NH2	2.34	0.60
6:h:350:ALA:HB3	6:h:367:GLY:HA3	1.82	0.60
6:H:245:ASN:ND2	7:Q:307:GLU:OE2	2.33	0.60
1:A:52:MET:HG2	1:A:62:VAL:HG22	1.83	0.60
5:G:184:LYS:HB2	5:G:434:GLN:HB3	1.82	0.60
6:H:6:GLN:NE2	8:z:11:GLU:OE2	2.34	0.60
6:H:196:ASP:OD1	6:H:401:LYS:NZ	2.33	0.60
2:b:46:LEU:HD11	2:b:63:ILE:HA	1.83	0.60
2:b:222:GLN:NE2	2:b:303:ILE:O	2.35	0.60
2:B:491:TYR:OH	2:B:495:ARG:NH2	2.35	0.60

Continued on next page...

Continued from previous page...

Atom-1	Atom-2	Interatomic distance (Å)	Clash overlap (Å)
3:d:432:MET:HB2	3:d:437:ALA:HB2	1.83	0.60
8:z:134:ASP:HA	8:z:137:LYS:HE2	1.83	0.60
1:a:204:ASN:ND2	1:a:223:ALA:O	2.35	0.60
4:E:243:VAL:HB	4:E:395:ILE:HD12	1.84	0.60
4:E:74:LEU:HD11	4:E:90:ILE:HA	1.84	0.60
4:E:180:LEU:HD22	4:E:430:VAL:HG13	1.84	0.60
5:G:160:GLY:HA2	5:G:165:ILE:HD13	1.84	0.60
4:e:245:LEU:HD11	4:e:354:ILE:HD11	1.83	0.59
1:A:249:LEU:HD11	1:A:340:SER:HA	1.84	0.59
2:B:87:GLU:OE1	4:E:389:LYS:NZ	2.34	0.59
5:G:296:ILE:HG12	5:G:317:LEU:HD12	1.84	0.59
6:H:70:LEU:HB3	6:H:84:VAL:HG22	1.84	0.59
1:A:23:ASP:OD1	1:A:26:ARG:NH2	2.35	0.59
6:h:85:ASP:OD1	6:h:88:ARG:NH2	2.32	0.59
6:H:194:LEU:HB3	6:H:401:LYS:HE3	1.84	0.59
7:q:205:ASP:O	7:q:331:ARG:NH1	2.36	0.59
8:Z:7:ASN:HD22	8:Z:10:ALA:HB2	1.66	0.59
2:b:248:THR:OG1	4:e:287:LEU:O	2.21	0.59
4:e:41:GLN:HB3	4:e:554:VAL:HB	1.84	0.59
5:G:86:ASP:HA	5:G:90:GLY:HA2	1.83	0.59
7:Q:216:SER:OG	7:Q:219:ASN:ND2	2.36	0.59
8:z:22:ASN:HA	8:z:72:THR:HG21	1.84	0.59
1:A:264:ILE:HG22	1:A:266:ASP:H	1.67	0.59
7:Q:14:PHE:HB3	7:Q:18:TYR:HD2	1.67	0.59
2:B:184:LEU:HB3	2:B:187:SER:HB3	1.85	0.59
2:b:45:LEU:HD11	2:b:54:CYS:HB2	1.84	0.58
2:B:197:LYS:NZ	2:B:378:ASP:OD1	2.35	0.58
7:Q:29:ILE:HD12	7:Q:115:GLU:HG3	1.85	0.58
8:z:198:GLN:HB3	8:z:388:LEU:HD13	1.85	0.58
8:Z:100:GLU:OE1	8:Z:103:ARG:NH2	2.35	0.58
5:G:266:GLU:HB2	8:Z:265:SER:HB3	1.85	0.58
8:z:33:LEU:HD12	8:z:95:VAL:HG11	1.84	0.58
1:A:477:LEU:O	1:A:481:HIS:ND1	2.33	0.58
3:D:215:LEU:HD21	3:D:313:VAL:HG11	1.84	0.58
8:z:197:MET:HE1	8:z:216:ASP:HB3	1.85	0.58
5:g:562:PRO:HD2	5:g:565:ILE:HD12	1.84	0.58
7:Q:244:LYS:HA	7:Q:356:GLU:HA	1.85	0.58
8:Z:161:LYS:NZ	8:Z:397:ASP:OD2	2.36	0.58
3:d:138:MET:HE1	3:d:420:GLU:HB3	1.84	0.58
6:h:86:ILE:HD12	6:h:101:VAL:HG12	1.85	0.58
2:B:197:LYS:HD2	2:B:377:LEU:HB3	1.85	0.58

Continued on next page...

Continued from previous page...

Atom-1	Atom-2	Interatomic distance (Å)	Clash overlap (Å)
3:D:158:LEU:HD21	3:D:397:ALA:HB2	1.86	0.58
4:e:191:LYS:HB2	4:e:193:VAL:HG12	1.85	0.58
4:E:322:ILE:HD13	4:E:354:ILE:HD13	1.85	0.58
6:h:198:LEU:HD13	6:h:373:THR:HG22	1.86	0.58
8:z:35:THR:OG1	8:z:44:LYS:NZ	2.36	0.58
8:z:88:GLY:HA3	8:z:400:ARG:HG3	1.84	0.58
1:A:49:LEU:HD22	5:G:582:ARG:HA	1.86	0.58
1:A:59:ASP:OD1	5:G:76:LYS:NZ	2.37	0.58
2:b:243:VAL:HG12	2:b:244:LYS:HG2	1.86	0.58
2:B:69:LEU:HD13	2:B:74:ALA:HB1	1.85	0.58
3:d:234:ILE:HA	3:d:285:VAL:HB	1.85	0.58
4:e:71:ASP:HA	4:e:85:ASN:HB3	1.86	0.58
4:e:555:ILE:HD12	6:h:53:ILE:HG12	1.86	0.58
5:G:251:GLU:HG2	5:G:302:SER:HB3	1.83	0.58
7:q:56:VAL:HG22	7:q:62:ILE:HG12	1.85	0.58
7:q:356:GLU:H	7:q:373:GLN:HG3	1.68	0.58
8:z:27:GLU:OE2	8:Z:110:GLN:NE2	2.36	0.58
3:D:163:VAL:HG22	3:D:204:ILE:HD13	1.86	0.57
5:G:202:ARG:O	5:G:327:ARG:NH2	2.37	0.57
6:H:147:ILE:HD13	6:H:409:ILE:HG13	1.85	0.57
7:Q:39:HIS:NE2	7:Q:109:GLU:OE2	2.35	0.57
4:e:373:LYS:NZ	6:h:309:ASP:OD2	2.37	0.57
8:Z:337:GLN:NE2	8:Z:339:SER:O	2.37	0.57
1:A:54:VAL:HG12	1:A:56:ASP:H	1.69	0.57
2:b:197:LYS:NZ	2:b:378:ASP:OD1	2.33	0.57
5:G:480:GLU:HG2	5:G:512:ILE:HD12	1.87	0.57
6:H:143:LEU:HD23	6:H:477:LYS:HD2	1.85	0.57
1:a:90:GLN:HB3	1:a:98:THR:HG22	1.86	0.57
4:e:550:LYS:O	6:h:50:ASP:N	2.38	0.57
6:H:255:ASP:OD1	6:H:256:ASN:ND2	2.38	0.57
8:Z:21:VAL:HG11	8:Z:533:LEU:HD13	1.86	0.57
1:a:23:ASP:OD1	1:a:26:ARG:NH2	2.37	0.57
7:Q:486:GLU:HG2	7:Q:492:THR:HG21	1.85	0.57
3:d:195:ARG:NH2	3:d:320:GLU:OE2	2.37	0.57
4:e:162:GLU:OE2	4:e:438:ARG:NH1	2.38	0.57
6:H:226:TYR:HB3	6:H:304:THR:HG21	1.87	0.57
6:H:241:ILE:HD13	6:H:330:VAL:HG11	1.85	0.57
7:Q:56:VAL:HG22	7:Q:62:ILE:HG12	1.86	0.57
3:D:298:ASN:OD1	3:D:299:ASP:N	2.38	0.57
6:H:342:LYS:HB2	6:H:345:HIS:HD2	1.68	0.57
1:a:430:ASN:HD22	1:a:456:LEU:HD21	1.70	0.57

Continued on next page...

Continued from previous page...

Atom-1	Atom-2	Interatomic distance (Å)	Clash overlap (Å)
2:b:223:PRO:HG2	2:b:226:ILE:HD11	1.86	0.57
6:h:236:PHE:HB2	6:h:352:PHE:HB3	1.86	0.57
8:Z:196:ILE:HG21	8:Z:392:LYS:HG3	1.87	0.57
5:G:43:ALA:O	8:Z:116:ARG:NH2	2.37	0.57
6:h:221:LYS:HG3	6:h:362:TYR:HE1	1.70	0.57
5:G:18:ARG:NH1	5:G:112:ILE:O	2.38	0.57
7:q:92:GLN:NE2	7:q:98:ASP:O	2.37	0.57
7:q:347:PRO:HB3	7:q:352:LEU:HD21	1.87	0.57
5:g:557:TYR:HD2	5:g:559:ILE:HG13	1.69	0.56
1:A:342:SER:OG	3:D:268:ARG:NH1	2.38	0.56
1:A:462:LEU:HB3	1:A:504:LEU:HD11	1.86	0.56
2:B:110:ILE:O	3:d:13:ASN:ND2	2.38	0.56
2:b:212:PHE:HB2	2:b:320:VAL:HG21	1.86	0.56
6:h:62:ILE:O	6:h:391:ARG:NH2	2.38	0.56
7:q:39:HIS:NE2	7:q:109:GLU:OE2	2.36	0.56
7:q:267:LEU:HD13	7:q:273:MET:HG2	1.86	0.56
8:z:116:ARG:NH1	8:z:120:ASP:OD1	2.39	0.56
8:z:210:ILE:HG22	8:z:212:GLY:H	1.70	0.56
8:Z:246:GLU:O	8:Z:247:VAL:HG22	2.05	0.56
2:b:510:ARG:O	4:e:71:ASP:N	2.37	0.56
5:G:174:LEU:HD22	5:G:219:VAL:HG23	1.88	0.56
5:G:263:ILE:HG23	5:G:268:ASP:HB2	1.88	0.56
6:h:171:ILE:HG23	6:h:178:PHE:HD2	1.71	0.56
6:h:234:LYS:HB3	6:h:354:GLU:HB3	1.86	0.56
7:q:93:LYS:NZ	7:q:403:ASP:OD1	2.36	0.56
1:A:39:VAL:O	1:A:51:LYS:NZ	2.38	0.56
6:h:215:ILE:HD13	6:h:366:GLN:HG2	1.87	0.56
6:H:277:LEU:HD21	7:Q:274:LEU:HA	1.87	0.56
7:q:25:ASP:OD1	8:Z:15:ARG:NH1	2.37	0.56
7:Q:162:MET:HE3	7:Q:411:LEU:HD21	1.86	0.56
1:A:236:ARG:HG3	1:A:362:VAL:HG12	1.87	0.56
1:A:549:PRO:HA	3:D:51:SER:HB2	1.88	0.56
4:E:74:LEU:HB2	4:E:82:THR:HB	1.87	0.56
5:G:70:VAL:HB	5:G:79:LEU:HD11	1.88	0.56
7:q:19:ASN:HB2	7:q:546:MET:HB2	1.87	0.56
8:z:42:THR:OG1	8:z:44:LYS:NZ	2.35	0.56
2:B:218:PHE:HB3	2:B:222:GLN:HB2	1.87	0.56
4:E:148:ASN:OD1	6:H:173:ASN:ND2	2.39	0.56
5:G:353:GLY:N	5:G:369:ASP:O	2.35	0.56
3:D:34:ALA:O	3:D:46:LYS:NZ	2.37	0.56
4:e:222:ASP:HB2	6:h:361:ARG:HH21	1.71	0.56

Continued on next page...

Continued from previous page...

Atom-1	Atom-2	Interatomic distance (Å)	Clash overlap (Å)
5:g:45:LEU:N	8:z:529:LEU:O	2.39	0.56
1:a:301:GLY:HA2	1:a:319:ARG:HB2	1.88	0.55
2:b:45:LEU:HD23	3:d:524:ILE:HG12	1.89	0.55
2:B:425:LYS:HG2	3:d:8:ASN:HD22	1.71	0.55
2:B:451:ASP:OD2	2:B:454:GLU:N	2.39	0.55
4:E:91:LEU:HB3	4:E:105:VAL:HG22	1.88	0.55
7:Q:45:SER:HB3	7:Q:66:ASN:HB2	1.88	0.55
8:z:29:LEU:HD22	8:z:73:ALA:HB1	1.88	0.55
1:A:90:GLN:HE22	1:A:94:ILE:HD12	1.72	0.55
3:D:70:ILE:HG22	3:D:72:HIS:H	1.72	0.55
3:D:161:LYS:NZ	3:D:396:ASP:OD2	2.39	0.55
4:e:230:VAL:HA	4:e:416:VAL:HG21	1.88	0.55
4:e:358:THR:HB	4:e:376:THR:H	1.71	0.55
6:h:70:LEU:HB3	6:h:84:VAL:HG22	1.89	0.55
1:a:251:LEU:HD12	1:a:302:ILE:HG12	1.87	0.55
1:a:549:PRO:HA	3:d:51:SER:HB2	1.87	0.55
1:A:227:THR:OG1	1:A:319:ARG:NH2	2.35	0.55
2:b:33:VAL:HB	2:b:93:THR:HG23	1.87	0.55
3:d:6:PRO:HD2	4:E:516:GLY:HA3	1.88	0.55
3:D:392:ARG:HA	3:D:395:HIS:HD2	1.71	0.55
4:E:283:THR:HB	6:H:257:ALA:HB1	1.89	0.55
8:Z:196:ILE:HG23	8:Z:380:ILE:HG13	1.88	0.55
2:b:335:CYS:SG	4:e:333:HIS:NE2	2.76	0.55
3:D:326:LYS:O	3:D:370:ASN:ND2	2.39	0.55
5:G:231:HIS:HB3	5:G:234:MET:HG2	1.87	0.55
6:h:215:ILE:HG22	6:h:217:GLY:H	1.70	0.55
7:q:211:LYS:NZ	7:q:395:ASP:OD1	2.40	0.55
7:Q:209:VAL:HB	7:Q:398:GLU:HG3	1.88	0.55
7:Q:224:LYS:HB2	7:Q:373:GLN:H	1.72	0.55
8:z:86:ILE:HG13	8:z:87:THR:HG23	1.88	0.55
3:d:106:ALA:HB1	3:d:442:GLU:HB3	1.87	0.55
5:g:309:LEU:HB3	5:g:314:CYS:HB2	1.87	0.55
5:G:111:LEU:HA	5:G:115:ASN:HA	1.89	0.55
7:q:79:HIS:HE1	7:q:81:ALA:HB3	1.72	0.55
7:Q:164:LYS:HE3	7:Q:175:GLU:HB3	1.89	0.55
7:Q:290:GLU:HB3	7:Q:346:ALA:HB2	1.88	0.55
3:d:60:ASP:OD1	3:d:93:THR:OG1	2.22	0.55
5:g:242:ARG:N	5:g:293:THR:OG1	2.34	0.55
5:G:242:ARG:H	5:G:293:THR:HG1	1.54	0.55
5:G:290:VAL:HG23	5:G:292:PRO:HD3	1.88	0.55
7:Q:77:ILE:HG13	7:Q:86:VAL:HG21	1.87	0.55

Continued on next page...

Continued from previous page...

Atom-1	Atom-2	Interatomic distance (Å)	Clash overlap (Å)
7:Q:521:LEU:HG	7:Q:525:LYS:HE3	1.87	0.55
8:z:183:ASP:OD2	8:z:188:ASN:N	2.40	0.55
4:e:313:VAL:HG13	4:e:318:ALA:HB3	1.87	0.55
4:E:382:GLU:HG2	4:E:393:LEU:HA	1.89	0.55
2:b:408:GLU:OE2	2:b:494:LYS:NZ	2.35	0.55
5:g:183:ARG:HB2	5:g:197:GLU:HB3	1.88	0.55
5:g:224:LEU:HD11	5:g:365:PHE:HB3	1.89	0.55
8:Z:46:LEU:HD11	8:Z:62:LEU:HD23	1.88	0.55
1:a:143:VAL:O	1:a:498:ARG:NH1	2.40	0.55
2:b:221:ASN:HD21	3:d:332:PRO:HD2	1.71	0.55
3:D:183:ASP:HB3	3:D:189:VAL:HG22	1.89	0.55
5:G:309:LEU:HB3	5:G:314:CYS:HB2	1.89	0.55
6:h:163:ARG:HG2	6:h:179:VAL:HG21	1.89	0.55
8:Z:7:ASN:ND2	8:Z:9:LYS:O	2.40	0.55
2:b:230:LYS:HB2	2:b:281:ILE:HA	1.89	0.54
2:B:514:ILE:HG12	4:E:73:ILE:HD12	1.89	0.54
7:q:29:ILE:HD12	7:q:115:GLU:HG3	1.89	0.54
5:g:111:LEU:HD21	5:g:118:PRO:HG3	1.88	0.54
7:q:14:PHE:HB3	7:q:18:TYR:HD2	1.72	0.54
7:Q:202:PHE:HB2	7:Q:412:MET:HE3	1.89	0.54
1:A:199:PRO:HB2	1:A:202:ALA:HB2	1.90	0.54
4:e:271:ILE:HG12	4:e:322:ILE:HD11	1.89	0.54
5:G:41:PRO:HA	5:G:161:THR:HA	1.89	0.54
5:G:474:PRO:O	5:G:479:THR:OG1	2.23	0.54
8:Z:128:GLU:HB3	8:Z:425:TYR:HE2	1.72	0.54
2:b:245:ILE:HG22	4:e:278:PRO:HB3	1.88	0.54
2:B:121:ILE:HG23	2:B:506:GLU:HG2	1.90	0.54
6:H:65:ASP:OD1	6:H:98:THR:OG1	2.23	0.54
7:q:28:ILE:O	7:q:29:ILE:HG12	2.06	0.54
8:Z:86:ILE:HG13	8:Z:87:THR:HG23	1.89	0.54
4:e:74:LEU:HD11	4:e:90:ILE:HA	1.88	0.54
3:d:236:LEU:HB2	3:d:332:PRO:HA	1.90	0.54
4:e:122:VAL:HG22	4:e:537:GLN:HA	1.88	0.54
4:e:212:MET:HE2	4:e:217:LYS:HD2	1.89	0.54
4:e:356:ILE:HD11	6:h:230:GLU:HG3	1.90	0.54
4:E:273:THR:HG22	4:E:351:LEU:HD13	1.90	0.54
4:E:556:ILE:HA	6:H:54:VAL:HB	1.89	0.54
2:B:125:ARG:NH2	4:E:194:SER:OG	2.41	0.54
2:B:225:ARG:NH1	2:B:344:GLU:OE1	2.40	0.54
2:B:287:ARG:HH21	2:B:311:PHE:HB3	1.71	0.54
8:z:37:LEU:O	8:z:461:ASN:ND2	2.37	0.54

Continued on next page...

Continued from previous page...

Atom-1	Atom-2	Interatomic distance (Å)	Clash overlap (Å)
8:Z:141:THR:HG22	8:Z:143:LEU:H	1.72	0.54
1:a:184:LEU:HD11	1:a:198:TYR:HB3	1.90	0.54
1:a:202:ALA:HA	1:a:328:ARG:HH11	1.73	0.54
3:d:298:ASN:OD1	3:d:299:ASP:N	2.41	0.54
4:e:291:SER:OG	4:e:292:VAL:N	2.41	0.54
6:H:144:ALA:HB1	6:H:408:LEU:HD22	1.90	0.54
8:z:149:PHE:HZ	8:z:411:ILE:HG13	1.72	0.54
1:a:138:ARG:NH2	1:a:432:TYR:OH	2.40	0.54
1:A:126:ILE:HD13	1:A:536:VAL:HG13	1.90	0.54
4:E:401:THR:HG23	4:E:403:THR:H	1.72	0.54
3:D:130:ARG:NH2	3:D:428:GLU:OE2	2.41	0.54
6:H:85:ASP:OD1	6:H:88:ARG:NH2	2.38	0.54
8:z:230:ASN:O	8:z:292:GLY:N	2.36	0.54
2:b:242:LYS:HG2	3:d:248:THR:HG21	1.88	0.53
4:e:64:SER:OG	4:e:72:LYS:NZ	2.37	0.53
5:G:80:GLU:OE1	5:G:83:ARG:NH1	2.41	0.53
6:H:170:LEU:O	6:H:171:ILE:HG12	2.08	0.53
1:A:501:GLY:HA2	1:A:509:ILE:HG23	1.89	0.53
2:B:111:ASP:O	2:B:114:LYS:NZ	2.32	0.53
2:B:241:ASP:OD2	2:B:268:LYS:NZ	2.41	0.53
2:B:335:CYS:HG	4:E:333:HIS:HE2	1.56	0.53
4:e:157:ALA:HB1	4:e:450:MET:HB3	1.90	0.53
7:Q:373:GLN:HG3	7:Q:374:GLU:H	1.74	0.53
1:A:110:LYS:NZ	6:h:117:GLU:OE2	2.41	0.53
2:b:83:VAL:HG13	4:e:231:GLY:HA2	1.91	0.53
3:d:473:HIS:NE2	3:d:480:ASP:O	2.41	0.53
3:D:411:ILE:HG23	3:D:501:VAL:HG22	1.90	0.53
4:e:412:ASN:OD1	4:e:413:LYS:N	2.41	0.53
5:G:45:LEU:N	8:Z:529:LEU:O	2.41	0.53
7:q:258:ASN:HD21	8:z:259:ARG:HH21	1.56	0.53
7:Q:72:LEU:HB3	7:Q:86:VAL:HG13	1.91	0.53
2:B:105:GLU:HB3	2:B:432:ALA:HB1	1.89	0.53
2:B:252:VAL:HG21	2:B:258:LEU:HD13	1.90	0.53
2:B:510:ARG:O	4:E:71:ASP:N	2.40	0.53
6:H:206:GLY:O	6:H:379:ARG:NE	2.34	0.53
1:A:130:ARG:HG2	1:A:532:LEU:HD21	1.89	0.53
5:g:456:LEU:HG	5:g:460:MET:HE2	1.91	0.53
5:G:96:VAL:HG22	5:G:569:SER:HA	1.91	0.53
4:E:358:THR:HG22	4:E:377:CYS:HB3	1.89	0.53
5:G:72:HIS:HB3	5:G:75:ALA:HB3	1.91	0.53
5:G:562:PRO:HD2	5:G:565:ILE:HD12	1.89	0.53

Continued on next page...

Continued from previous page...

Atom-1	Atom-2	Interatomic distance (Å)	Clash overlap (Å)
7:q:250:PHE:HD2	7:q:254:LEU:HD11	1.73	0.53
7:Q:327:PHE:HB3	7:Q:331:ARG:HH12	1.73	0.53
1:A:115:LEU:HD21	1:A:450:GLU:HG3	1.91	0.53
8:z:309:PHE:HB3	8:z:314:ILE:HB	1.91	0.53
8:Z:241:GLU:HA	8:Z:302:ASP:HB2	1.91	0.53
2:B:277:SER:HB3	2:B:301:LEU:HD13	1.91	0.53
3:d:523:ASP:OD1	3:d:524:ILE:N	2.42	0.53
3:D:121:ALA:HB1	3:D:516:LYS:HG3	1.89	0.53
4:E:397:GLN:HG3	4:E:401:THR:HG21	1.90	0.53
5:g:66:ARG:HH21	5:g:454:ARG:HH22	1.57	0.53
2:B:289:LEU:HA	2:B:307:GLU:HB2	1.90	0.53
4:e:237:SER:OG	4:e:407:PHE:O	2.24	0.53
5:g:42:LYS:HE3	5:g:547:ASP:HA	1.91	0.53
5:G:205:ARG:HE	5:G:207:GLU:HB2	1.74	0.53
6:h:431:ILE:HG21	6:h:435:GLN:HB2	1.90	0.53
2:B:14:ARG:NH2	4:E:59:SER:OG	2.42	0.52
5:g:205:ARG:NH2	5:g:324:ASP:OD1	2.42	0.52
5:g:339:ARG:NH2	5:g:341:GLU:OE1	2.42	0.52
5:g:361:GLY:HA2	8:z:192:HIS:HE1	1.74	0.52
6:H:204:ILE:HG21	6:H:357:ILE:HG22	1.92	0.52
7:q:27:GLN:HG2	7:q:28:ILE:H	1.74	0.52
7:q:91:GLN:HG2	7:q:526:PHE:HZ	1.74	0.52
2:B:285:ILE:HG12	2:B:306:ILE:HD12	1.90	0.52
5:g:231:HIS:HB3	5:g:234:MET:HG2	1.91	0.52
5:G:481:MET:HE3	5:G:531:LEU:HD23	1.92	0.52
2:b:310:ASP:OD1	2:b:311:PHE:N	2.42	0.52
3:d:346:SER:HB3	3:d:367:ARG:HB2	1.92	0.52
4:e:279:PRO:HG2	4:e:305:LYS:HE2	1.91	0.52
4:E:122:VAL:HG12	4:E:537:GLN:HA	1.92	0.52
4:E:243:VAL:H	4:E:395:ILE:HB	1.75	0.52
6:h:44:LEU:HD23	6:h:452:GLN:HB2	1.92	0.52
7:q:79:HIS:CE1	7:q:81:ALA:HB3	2.44	0.52
8:z:113:VAL:HG13	8:z:117:ILE:HD11	1.92	0.52
1:a:4:LEU:O	4:E:35:GLN:NE2	2.43	0.52
3:d:219:ALA:HB2	3:d:311:MET:HE3	1.92	0.52
5:G:45:LEU:HD23	5:G:59:ASN:HB3	1.90	0.52
4:e:362:ILE:HB	6:h:305:GLN:HE22	1.74	0.52
5:g:42:LYS:HG2	8:z:116:ARG:HG2	1.90	0.52
5:G:145:VAL:HG12	5:G:466:VAL:HG22	1.92	0.52
7:q:8:ASN:OD1	7:q:9:PRO:HD2	2.10	0.52
7:q:15:LYS:NZ	8:z:67:GLN:OE1	2.37	0.52

Continued on next page...

Continued from previous page...

Atom-1	Atom-2	Interatomic distance (Å)	Clash overlap (Å)
7:Q:428:ILE:HD11	7:Q:460:PRO:HB3	1.92	0.52
8:z:89:ASP:OD1	8:z:90:GLY:N	2.43	0.52
8:Z:68:ILE:HG21	8:Z:73:ALA:HB3	1.90	0.52
1:a:198:TYR:HD2	1:a:410:LYS:HG3	1.75	0.52
2:b:514:ILE:HG12	4:e:73:ILE:HD12	1.90	0.52
5:g:121:ILE:HG12	5:g:501:PRO:HB3	1.90	0.52
2:b:192:HIS:HB3	2:b:364:ALA:HA	1.91	0.52
4:E:212:MET:HA	4:E:219:VAL:HG23	1.92	0.52
6:h:360:GLU:OE1	6:h:362:TYR:OH	2.26	0.52
7:Q:227:VAL:HG21	7:Q:385:ILE:HD11	1.90	0.52
8:Z:329:GLN:HE21	8:Z:336:ALA:H	1.57	0.52
3:d:25:ILE:HG23	3:d:104:LEU:HB3	1.92	0.52
3:D:215:LEU:HB3	3:D:361:VAL:HB	1.92	0.52
4:E:554:VAL:HG13	6:H:52:LEU:HD23	1.92	0.52
5:g:18:ARG:NH2	5:g:115:ASN:OD1	2.42	0.52
6:h:121:SER:HB3	6:h:123:HIS:CE1	2.45	0.52
6:H:86:ILE:HD12	6:H:101:VAL:HG12	1.91	0.52
6:H:307:PHE:HD2	6:H:314:CYS:HB2	1.75	0.52
1:A:118:ASN:OD1	6:h:451:ARG:NH1	2.43	0.52
1:A:287:LYS:NZ	1:A:348:GLU:O	2.43	0.52
1:A:300:LYS:HA	1:A:320:ARG:HG2	1.92	0.52
2:B:237:THR:O	2:B:238:LEU:HG	2.10	0.52
4:E:279:PRO:HB3	6:H:271:VAL:HG11	1.90	0.52
6:H:197:LYS:NZ	7:Q:231:GLU:OE2	2.43	0.52
7:q:148:GLY:HA3	7:q:419:LEU:HB2	1.92	0.52
7:Q:258:ASN:OD1	8:Z:259:ARG:NH2	2.35	0.52
8:z:204:PRO:HG3	8:z:382:GLY:HA2	1.91	0.52
8:Z:89:ASP:OD1	8:Z:90:GLY:N	2.43	0.52
1:a:96:ASP:OD1	1:a:97:GLY:N	2.43	0.51
4:e:229:ARG:NH2	4:e:390:ASP:OD2	2.43	0.51
6:H:216:ASN:HD22	6:H:367:GLY:H	1.56	0.51
7:Q:25:ASP:OD1	8:z:14:ARG:NH1	2.44	0.51
7:q:502:ASP:OD1	7:q:503:GLY:N	2.42	0.51
8:Z:37:LEU:O	8:Z:461:ASN:ND2	2.43	0.51
8:Z:280:LEU:HD21	8:Z:348:LEU:HD21	1.92	0.51
1:A:363:GLN:HE21	1:A:370:GLU:HB3	1.75	0.51
4:e:188:LEU:HD21	4:e:426:SER:HB2	1.93	0.51
5:g:110:TYR:O	5:g:115:ASN:N	2.42	0.51
1:A:64:ASN:ND2	1:A:166:SER:O	2.43	0.51
2:B:59:ASP:OD1	2:B:92:THR:OG1	2.28	0.51
2:B:95:VAL:HG22	2:B:497:VAL:HA	1.92	0.51

Continued on next page...

Continued from previous page...

Atom-1	Atom-2	Interatomic distance (Å)	Clash overlap (Å)
2:B:256:ALA:HB2	3:D:266:GLU:HG3	1.93	0.51
3:D:462:SER:OG	4:e:139:LYS:O	2.29	0.51
5:G:205:ARG:HG3	5:G:207:GLU:H	1.76	0.51
7:q:109:GLU:HG3	7:q:458:VAL:HG11	1.91	0.51
7:q:146:VAL:HG21	7:q:521:LEU:HD22	1.91	0.51
7:Q:2:SER:N	8:z:69:GLN:O	2.44	0.51
6:h:206:GLY:O	6:h:379:ARG:NE	2.41	0.51
7:q:146:VAL:HG11	7:q:418:LYS:HD3	1.91	0.51
7:q:214:GLY:O	7:q:387:ARG:NE	2.38	0.51
7:q:247:VAL:HG22	7:q:298:CYS:HB3	1.92	0.51
1:A:47:VAL:O	5:G:117:HIS:NE2	2.39	0.51
1:A:53:LEU:HD22	5:G:590:VAL:HG21	1.93	0.51
7:Q:155:ASP:HB3	7:Q:158:GLU:HB2	1.92	0.51
7:Q:361:MET:HE3	7:Q:370:VAL:HG21	1.93	0.51
8:z:201:HIS:ND1	8:z:202:LEU:HG	2.26	0.51
2:B:118:GLN:HE21	2:B:122:GLU:HG3	1.76	0.51
2:B:252:VAL:HB	3:D:252:ILE:HG12	1.92	0.51
3:D:113:LYS:HB3	4:e:492:ILE:HD11	1.92	0.51
5:g:242:ARG:H	5:g:293:THR:HG1	1.57	0.51
8:Z:134:ASP:HA	8:Z:137:LYS:HE2	1.92	0.51
1:A:322:LYS:HE2	1:A:324:GLU:HB2	1.92	0.51
2:b:69:LEU:HD13	2:b:74:ALA:HB1	1.92	0.51
3:d:289:GLN:HE21	3:d:321:ILE:HD11	1.75	0.51
3:D:89:ALA:O	3:D:402:ARG:NH2	2.40	0.51
4:e:188:LEU:HD22	4:e:193:VAL:HG11	1.93	0.51
5:g:42:LYS:HD2	5:g:520:ALA:HA	1.93	0.51
5:G:230:VAL:HG22	5:G:318:ARG:NH2	2.26	0.51
7:Q:255:ASP:OD1	7:Q:256:ILE:N	2.43	0.51
8:z:207:THR:OG1	8:z:379:LEU:O	2.28	0.51
8:Z:230:ASN:O	8:Z:292:GLY:N	2.43	0.51
1:A:343:ASN:H	3:D:268:ARG:HH12	1.59	0.51
3:D:210:ILE:HG22	3:D:212:GLY:H	1.76	0.51
5:g:86:ASP:HA	5:g:90:GLY:HA2	1.93	0.51
2:B:90:ASP:OD1	2:B:91:GLY:N	2.42	0.50
3:d:223:ALA:HB1	3:d:306:SER:HB2	1.92	0.50
4:e:282:LYS:HB3	6:h:251:LYS:HB2	1.93	0.50
6:h:60:THR:O	6:h:384:GLN:NE2	2.44	0.50
6:h:158:LEU:HD11	6:h:404:LEU:HD21	1.93	0.50
6:H:342:LYS:HB2	6:H:345:HIS:CD2	2.46	0.50
8:Z:210:ILE:HG22	8:Z:212:GLY:H	1.76	0.50
8:Z:239:SER:HB3	8:Z:299:LYS:HB2	1.93	0.50

Continued on next page...

Continued from previous page...

Atom-1	Atom-2	Interatomic distance (Å)	Clash overlap (Å)
8:Z:240:LEU:HD21	8:Z:273:LYS:HD2	1.93	0.50
2:B:214:LEU:HG	2:B:216:LYS:H	1.76	0.50
4:E:147:ALA:HB1	4:E:546:ARG:HG3	1.93	0.50
5:G:39:LEU:O	5:G:519:ASN:ND2	2.44	0.50
7:q:49:CYS:O	7:q:51:ARG:NH1	2.44	0.50
7:Q:253:PRO:HB3	7:Q:303:ALA:HB3	1.94	0.50
8:z:60:LYS:HB2	8:z:91:THR:HG21	1.92	0.50
1:a:93:GLU:HG3	3:d:356:ASP:HB3	1.93	0.50
4:E:555:ILE:HD12	6:H:53:ILE:HG12	1.93	0.50
6:h:218:VAL:HG11	6:h:325:ARG:HG2	1.93	0.50
7:q:54:ILE:HG12	7:q:64:ILE:HG12	1.93	0.50
1:a:156:LEU:HD11	1:a:413:LEU:HD21	1.93	0.50
4:e:377:CYS:HA	4:e:397:GLN:HE22	1.76	0.50
4:E:256:LYS:HE2	4:E:391:ARG:HH12	1.77	0.50
4:E:383:GLN:HG3	4:E:385:PHE:H	1.77	0.50
7:q:17:GLY:HA3	7:q:548:LYS:HB2	1.94	0.50
1:a:11:ASP:O	1:a:12:THR:OG1	2.27	0.50
2:b:237:THR:HG23	2:b:286:ASN:HD21	1.77	0.50
3:d:462:SER:OG	4:E:139:LYS:O	2.24	0.50
4:E:65:LEU:O	4:E:486:ASN:ND2	2.43	0.50
8:z:404:ASN:ND2	8:z:509:SER:OG	2.39	0.50
8:Z:420:ILE:HD13	8:Z:473:VAL:HG11	1.93	0.50
5:g:65:LEU:HD11	5:g:97:ILE:HG13	1.94	0.50
6:h:86:ILE:HG22	7:q:389:ALA:HB1	1.94	0.50
7:q:255:ASP:OD1	7:q:256:ILE:N	2.44	0.50
1:A:94:ILE:HG21	1:A:523:SER:HA	1.93	0.50
2:b:193:ILE:HD13	2:b:388:LEU:HD13	1.93	0.50
2:B:315:GLU:OE1	4:E:253:GLN:NE2	2.45	0.50
3:D:115:ILE:HG21	3:D:439:ILE:HD11	1.94	0.50
6:H:216:ASN:HB2	6:H:366:GLN:HA	1.94	0.50
7:q:184:GLU:HB3	7:q:222:VAL:HG21	1.93	0.50
7:Q:184:GLU:HB3	7:Q:222:VAL:HG21	1.92	0.50
1:A:47:VAL:HG22	1:A:504:LEU:HD13	1.94	0.50
1:A:308:LYS:HE2	5:G:339:ARG:HB2	1.94	0.50
2:b:110:ILE:O	3:D:13:ASN:ND2	2.35	0.50
2:B:489:GLU:HB2	2:B:494:LYS:HE2	1.94	0.50
3:D:42:LYS:HE2	3:D:484:VAL:HB	1.93	0.50
5:g:160:GLY:HA2	5:g:165:ILE:HD13	1.93	0.50
5:G:225:LEU:HB2	5:G:366:SER:HB3	1.92	0.50
8:z:298:GLN:HA	8:z:320:ALA:HB3	1.94	0.50
4:e:41:GLN:HE21	4:e:46:ALA:HA	1.76	0.49

Continued on next page...

Continued from previous page...

Atom-1	Atom-2	Interatomic distance (Å)	Clash overlap (Å)
4:E:268:LYS:HB3	4:E:374:LEU:HD13	1.94	0.49
8:Z:153:VAL:HG11	8:Z:405:VAL:HG21	1.94	0.49
8:Z:294:VAL:HG12	8:Z:315:LEU:HB3	1.93	0.49
2:b:191:GLU:O	2:b:316:ARG:NE	2.33	0.49
4:e:251:HIS:H	4:e:254:MET:HE3	1.77	0.49
5:G:89:VAL:HG13	5:G:465:ASN:HD21	1.77	0.49
6:h:85:ASP:HB3	7:q:390:THR:HA	1.94	0.49
7:Q:22:SER:HA	7:Q:543:GLN:HA	1.95	0.49
1:a:115:LEU:HD21	1:a:450:GLU:HG3	1.93	0.49
2:B:347:MET:HA	2:B:352:PRO:HA	1.93	0.49
3:D:86:ASP:HA	3:D:90:GLY:HA2	1.95	0.49
3:D:132:VAL:HG22	3:D:505:THR:HG23	1.93	0.49
6:h:243:SER:HB2	6:h:334:ILE:HG12	1.94	0.49
6:h:481:VAL:HA	6:h:488:ILE:HG22	1.93	0.49
1:A:153:LYS:NZ	1:A:182:ASP:OD1	2.42	0.49
2:b:249:LYS:HE3	4:e:286:LYS:HD3	1.94	0.49
2:B:150:ARG:NH2	2:B:175:GLU:OE2	2.45	0.49
5:G:227:LYS:NZ	5:G:319:ARG:O	2.45	0.49
5:G:254:LYS:NZ	8:Z:246:GLU:OE1	2.44	0.49
7:q:46:MET:HB3	7:q:462:THR:HG21	1.95	0.49
7:q:65:THR:OG1	7:q:396:ASP:OD1	2.29	0.49
3:d:469:LEU:O	3:d:473:HIS:ND1	2.35	0.49
6:H:416:THR:HG21	6:H:503:LYS:HG3	1.94	0.49
7:q:411:LEU:HD12	7:q:417:GLY:H	1.78	0.49
8:z:27:GLU:OE2	8:Z:20:LYS:NZ	2.37	0.49
8:Z:37:LEU:HD21	8:Z:454:ILE:HG23	1.93	0.49
1:a:206:LEU:HD12	1:a:386:ILE:HG12	1.95	0.49
2:B:72:PRO:HB2	4:E:73:ILE:HD13	1.94	0.49
6:H:96:ASP:OD1	6:H:97:GLY:N	2.45	0.49
7:q:35:ILE:HG22	7:q:82:VAL:HG22	1.95	0.49
2:b:39:PRO:HB3	2:b:162:SER:HB2	1.95	0.49
4:e:554:VAL:HG13	6:h:52:LEU:HD23	1.95	0.49
4:E:52:LEU:HD23	4:E:55:ARG:HD3	1.95	0.49
7:q:150:ILE:HG22	7:q:152:ASP:H	1.78	0.49
7:q:224:LYS:HB3	7:q:378:ILE:HD13	1.94	0.49
8:z:63:LEU:HD22	8:z:68:ILE:HD11	1.94	0.49
1:a:226:CYS:SG	1:a:227:THR:N	2.86	0.49
1:A:342:SER:HB3	3:D:303:HIS:HD2	1.78	0.49
2:B:58:ASN:ND2	2:B:163:SER:O	2.46	0.49
2:B:230:LYS:HB2	2:B:281:ILE:HA	1.95	0.49
6:h:51:ILE:HD12	6:h:69:ILE:HD13	1.95	0.49

Continued on next page...

Continued from previous page...

Atom-1	Atom-2	Interatomic distance (Å)	Clash overlap (Å)
7:q:226:MET:HB2	7:q:371:PHE:HD2	1.78	0.49
1:a:487:ALA:O	1:a:488:LYS:HG2	2.12	0.49
4:e:208:VAL:O	4:e:212:MET:HG3	2.13	0.49
1:a:39:VAL:HG11	1:a:69:ILE:HG21	1.95	0.49
1:a:462:LEU:HB3	1:a:504:LEU:HD11	1.95	0.49
3:D:234:ILE:HA	3:D:285:VAL:HB	1.94	0.49
4:e:536:GLN:NE2	6:h:211:GLU:OE2	2.46	0.49
5:g:474:PRO:O	5:g:479:THR:OG1	2.26	0.49
6:H:428:SER:HB2	6:H:436:GLN:HG3	1.93	0.49
1:A:39:VAL:HG13	1:A:51:LYS:HD2	1.95	0.48
4:E:412:ASN:OD1	4:E:413:LYS:N	2.46	0.48
6:h:3:PHE:HZ	7:q:545:ILE:HG12	1.78	0.48
6:h:229:PHE:C	6:h:231:GLN:H	2.21	0.48
8:z:476:GLU:OE2	8:z:487:ARG:NH1	2.41	0.48
1:A:42:SER:OG	1:A:51:LYS:NZ	2.41	0.48
1:A:192:SER:HB2	1:A:195:GLU:HB3	1.94	0.48
2:b:347:MET:HA	2:b:352:PRO:HA	1.95	0.48
2:B:66:SER:HB3	3:D:527:SER:HB2	1.94	0.48
7:Q:223:ILE:HG23	7:Q:372:LYS:HB2	1.95	0.48
1:A:264:ILE:HG21	1:A:269:GLN:HB2	1.95	0.48
3:d:131:SER:HA	3:d:134:ILE:HD12	1.95	0.48
3:D:523:ASP:OD1	3:D:524:ILE:N	2.47	0.48
5:g:5:VAL:HG12	5:g:7:PHE:H	1.79	0.48
6:h:63:SER:OG	6:h:65:ASP:OD1	2.31	0.48
1:A:243:LYS:HD3	1:A:355:LEU:HD13	1.94	0.48
2:b:47:GLN:OE1	3:d:76:ARG:NH2	2.45	0.48
2:B:232:LEU:HD11	2:B:326:VAL:HB	1.95	0.48
4:E:32:VAL:HG21	6:H:73:LEU:HD13	1.95	0.48
6:h:218:VAL:HG21	6:h:326:VAL:HG22	1.96	0.48
3:d:272:LEU:HG	3:d:276:LYS:HE3	1.94	0.48
4:E:99:GLU:OE1	6:H:60:THR:OG1	2.31	0.48
7:Q:98:ASP:OD1	7:Q:99:GLY:N	2.47	0.48
1:a:120:ILE:HD11	6:H:462:ILE:HD11	1.95	0.48
1:a:363:GLN:HA	1:a:372:ILE:HA	1.96	0.48
1:A:78:PRO:HG3	3:D:49:LYS:HD2	1.95	0.48
5:g:48:LEU:HD13	5:g:67:GLU:HB2	1.96	0.48
6:H:468:LEU:HA	6:H:479:TYR:HE2	1.78	0.48
7:Q:390:THR:OG1	7:Q:393:ASN:ND2	2.31	0.48
8:Z:63:LEU:HD13	8:Z:77:ALA:HA	1.96	0.48
2:B:237:THR:OG1	2:B:241:ASP:OD1	2.30	0.48
4:e:176:PHE:HE2	4:e:212:MET:HE1	1.79	0.48

Continued on next page...

Continued from previous page...

Atom-1	Atom-2	Interatomic distance (Å)	Clash overlap (Å)
5:g:221:LYS:HA	5:g:437:CYS:HA	1.96	0.48
6:h:123:HIS:HB3	7:q:51:ARG:HH12	1.79	0.48
6:H:351:LEU:HD11	6:H:366:GLN:HE21	1.78	0.48
6:H:520:VAL:HG11	7:Q:54:ILE:HG13	1.96	0.48
1:a:55:ASP:HA	5:g:591:ARG:H	1.78	0.48
4:e:37:ASN:HB3	4:e:558:GLY:H	1.79	0.48
4:E:243:VAL:HG13	4:E:353:HIS:HD2	1.79	0.48
5:G:58:THR:HG21	5:G:63:ALA:HB3	1.95	0.48
1:A:497:TYR:O	1:A:498:ARG:HG2	2.13	0.48
3:D:50:THR:OG1	3:D:54:GLU:O	2.22	0.48
3:D:291:SER:HB2	3:D:296:ALA:HB2	1.96	0.48
6:H:197:LYS:O	6:H:325:ARG:NE	2.42	0.48
8:z:20:LYS:NZ	8:Z:27:GLU:OE2	2.43	0.48
8:z:328:LEU:O	8:z:332:THR:OG1	2.30	0.48
8:Z:100:GLU:OE2	8:Z:104:GLN:NE2	2.40	0.48
4:e:51:ILE:HG23	4:e:130:LEU:HB3	1.96	0.48
5:G:371:CYS:O	5:G:372:LYS:HG2	2.13	0.48
6:h:277:LEU:HD21	7:q:274:LEU:HA	1.95	0.48
6:H:336:SER:HB2	7:Q:311:HIS:HB2	1.96	0.48
7:Q:189:VAL:HG12	7:Q:381:THR:H	1.79	0.48
7:Q:232:PRO:HG2	7:Q:236:VAL:HG12	1.96	0.48
1:A:180:VAL:HG13	1:A:406:LEU:HD23	1.94	0.47
1:A:495:ARG:HD3	1:A:498:ARG:HH21	1.79	0.47
2:b:80:ILE:HG21	2:b:504:ALA:HB2	1.96	0.47
2:b:233:ILE:HG21	2:b:314:VAL:HG13	1.95	0.47
3:D:145:SER:H	3:D:179:LEU:HD21	1.79	0.47
6:h:422:LYS:HE3	6:h:473:SER:HA	1.95	0.47
6:H:171:ILE:HD13	6:H:389:VAL:HG13	1.96	0.47
1:a:135:GLU:HB3	1:a:432:TYR:HE2	1.79	0.47
1:a:220:PRO:HD2	1:a:375:LYS:HE2	1.95	0.47
2:b:55:MET:SD	2:b:382:ARG:NH1	2.85	0.47
5:g:197:GLU:O	5:g:198:ILE:HG13	2.14	0.47
7:q:57:ASN:OD1	7:q:61:LYS:N	2.47	0.47
7:q:394:LEU:HD23	7:q:397:ILE:HD12	1.96	0.47
1:A:219:VAL:HG21	1:A:373:LEU:HD22	1.96	0.47
2:B:68:PRO:HB3	3:D:528:ARG:HD3	1.96	0.47
3:D:41:PRO:HA	3:D:160:SER:HA	1.96	0.47
3:D:236:LEU:HB2	3:D:332:PRO:HA	1.95	0.47
4:e:88:ALA:HB2	4:e:119:THR:HG21	1.96	0.47
4:e:269:LEU:HD23	4:e:358:THR:HG21	1.96	0.47
5:G:114:LYS:NZ	7:q:461:ARG:HH22	2.13	0.47

Continued on next page...

Continued from previous page...

Atom-1	Atom-2	Interatomic distance (Å)	Clash overlap (Å)
6:h:465:LEU:HD23	6:h:468:LEU:HD12	1.97	0.47
6:H:37:GLN:HE21	6:H:103:ILE:HG23	1.77	0.47
7:q:29:ILE:HA	7:q:32:ILE:HD12	1.96	0.47
7:q:36:ARG:NH2	7:q:115:GLU:OE1	2.45	0.47
3:d:115:ILE:HG21	3:d:439:ILE:HD11	1.95	0.47
4:e:117:ASP:OD1	4:e:118:GLY:N	2.47	0.47
5:G:232:PRO:HG3	8:Z:326:GLU:HG2	1.96	0.47
6:h:229:PHE:O	6:h:230:GLU:HG2	2.14	0.47
6:h:382:ALA:HB3	6:h:385:VAL:HG23	1.97	0.47
7:q:21:TYR:O	7:q:544:ILE:N	2.37	0.47
1:a:252:GLN:HA	1:a:303:ASP:HB2	1.96	0.47
2:b:347:MET:O	3:d:188:ASN:ND2	2.47	0.47
2:B:5:ILE:O	4:E:97:ASP:N	2.47	0.47
2:B:198:ILE:HB	2:B:370:ARG:HD2	1.96	0.47
3:d:210:ILE:HG22	3:d:212:GLY:H	1.79	0.47
3:d:404:LEU:HD21	3:d:410:LEU:HD13	1.96	0.47
1:a:13:LEU:HG	1:a:15:LEU:HG	1.96	0.47
2:b:292:ASP:OD1	3:d:318:ARG:NH2	2.48	0.47
4:E:114:GLU:HB2	6:H:379:ARG:HH22	1.80	0.47
5:G:62:HIS:HE1	5:G:83:ARG:HG2	1.79	0.47
6:h:221:LYS:HG3	6:h:362:TYR:CE1	2.48	0.47
6:H:222:LYS:O	6:H:223:THR:OG1	2.29	0.47
8:Z:213:LEU:HB2	8:Z:331:VAL:HG21	1.97	0.47
1:a:64:ASN:ND2	1:a:166:SER:O	2.47	0.47
1:A:40:VAL:HB	1:A:99:THR:HG23	1.96	0.47
2:B:24:VAL:HA	2:B:27:ILE:HD12	1.96	0.47
2:B:43:ASP:N	3:D:520:ARG:O	2.47	0.47
2:B:212:PHE:HB2	2:B:320:VAL:HG21	1.96	0.47
3:D:59:ASN:ND2	3:D:160:SER:O	2.47	0.47
4:e:245:LEU:HB2	4:e:393:LEU:HB2	1.96	0.47
6:H:198:LEU:HD23	6:H:325:ARG:HG2	1.96	0.47
6:H:218:VAL:HB	6:H:373:THR:HG21	1.97	0.47
7:Q:23:ASN:N	7:Q:542:ASP:O	2.45	0.47
8:z:75:LEU:HD12	8:z:527:LEU:HD21	1.97	0.47
8:Z:217:HIS:NE2	8:Z:319:ARG:O	2.48	0.47
8:Z:412:ILE:HG21	8:Z:513:LEU:HD12	1.95	0.47
8:Z:431:MET:HE1	8:Z:444:ILE:HD12	1.96	0.47
1:A:207:LYS:NZ	1:A:396:ASP:OD1	2.38	0.47
4:E:112:ASP:HA	4:E:116:GLY:HA2	1.96	0.47
5:G:354:LEU:H	5:G:369:ASP:HB3	1.80	0.47
7:Q:22:SER:O	7:Q:27:GLN:HB3	2.14	0.47

Continued on next page...

Continued from previous page...

Atom-1	Atom-2	Interatomic distance (Å)	Clash overlap (Å)
1:a:295:VAL:HG21	1:a:361:VAL:HG11	1.97	0.47
2:b:95:VAL:HG22	2:b:497:VAL:HA	1.97	0.47
2:b:252:VAL:HG21	2:b:258:LEU:HD13	1.96	0.47
4:E:501:LYS:HG2	4:E:510:ILE:HG13	1.96	0.47
6:H:425:ARG:NH2	6:H:447:GLU:OE2	2.48	0.47
7:Q:500:ASP:OD1	7:Q:501:ILE:N	2.48	0.47
3:d:180:LYS:HD2	3:d:375:VAL:HG22	1.97	0.47
6:h:82:THR:HG23	7:q:390:THR:HG21	1.96	0.47
1:a:141:ASN:HA	1:a:144:LEU:HD23	1.95	0.46
1:A:462:LEU:HD12	1:A:502:LEU:HD21	1.97	0.46
2:b:76:VAL:HG21	2:b:508:LEU:HD21	1.97	0.46
2:b:345:GLU:HG3	2:b:354:LEU:HA	1.97	0.46
3:D:99:LEU:HD11	3:D:447:LEU:HD23	1.98	0.46
3:D:245:LYS:HB3	3:D:294:ARG:HD3	1.97	0.46
1:A:75:VAL:HA	5:G:8:MET:HB3	1.96	0.46
1:A:244:ILE:HD12	1:A:333:THR:HG21	1.96	0.46
2:b:513:ASN:OD1	2:b:514:ILE:N	2.48	0.46
2:B:252:VAL:HG11	2:B:258:LEU:HB2	1.96	0.46
4:E:421:ARG:HA	4:E:424:HIS:HB3	1.97	0.46
5:g:197:GLU:C	5:g:198:ILE:HG13	2.40	0.46
6:h:171:ILE:O	6:h:175:ALA:N	2.48	0.46
7:q:420:LEU:HD21	7:q:521:LEU:HD13	1.96	0.46
1:a:5:PHE:HB2	4:E:40:ARG:HB2	1.97	0.46
1:A:159:ILE:HG12	1:A:518:LEU:HB2	1.98	0.46
3:D:33:ASP:OD1	3:D:36:ARG:NH1	2.48	0.46
3:D:72:HIS:CE1	3:D:74:VAL:HB	2.50	0.46
4:E:32:VAL:HG11	6:H:73:LEU:HD22	1.98	0.46
4:E:229:ARG:HH22	4:E:389:LYS:HB3	1.81	0.46
4:E:382:GLU:OE1	4:E:391:ARG:NH2	2.49	0.46
8:Z:192:HIS:NE2	8:Z:326:GLU:OE1	2.39	0.46
1:a:430:ASN:HA	1:a:452:ALA:HB1	1.98	0.46
5:g:534:LYS:HE3	5:g:551:ILE:HD12	1.96	0.46
5:G:208:LYS:HB2	5:G:449:LEU:HD13	1.96	0.46
7:Q:35:ILE:HD13	7:Q:82:VAL:HG22	1.96	0.46
7:Q:145:MET:HE1	7:Q:426:THR:HA	1.98	0.46
8:z:413:PRO:HB3	8:z:501:PRO:HB2	1.97	0.46
3:D:291:SER:OG	3:D:294:ARG:O	2.33	0.46
4:e:185:LYS:HD3	4:e:197:HIS:HD2	1.80	0.46
6:h:224:PHE:O	6:h:225:SER:OG	2.26	0.46
7:q:22:SER:HB3	7:q:543:GLN:HG3	1.97	0.46
1:a:30:VAL:HG22	1:a:109:LEU:HG	1.97	0.46

Continued on next page...

Continued from previous page...

Atom-1	Atom-2	Interatomic distance (Å)	Clash overlap (Å)
1:A:171:ALA:HB1	5:G:126:LYS:HG3	1.98	0.46
2:B:34:LYS:HG3	2:B:443:ILE:HD13	1.98	0.46
5:G:243:VAL:HG22	5:G:294:LEU:HD23	1.98	0.46
7:q:239:LEU:HD23	7:q:240:SER:N	2.26	0.46
8:z:276:LYS:NZ	8:z:341:GLU:OE1	2.49	0.46
8:Z:14:ARG:HB3	8:Z:532:GLU:HG3	1.97	0.46
2:B:16:GLU:OE2	2:B:19:ARG:NH2	2.49	0.46
5:g:260:ASN:OD1	8:z:248:ASN:ND2	2.49	0.46
7:q:395:ASP:HB3	7:q:399:ARG:HH12	1.81	0.46
2:b:471:GLY:HA3	2:b:482:MET:HE3	1.97	0.46
3:d:290:LYS:HG2	3:d:315:ASP:HA	1.98	0.46
4:e:50:HIS:HB3	4:e:100:ILE:HG13	1.97	0.46
4:e:99:GLU:OE1	6:h:60:THR:OG1	2.29	0.46
4:E:58:ALA:HB1	4:E:62:LYS:HE3	1.98	0.46
5:g:441:LEU:HD13	5:g:452:ILE:HG22	1.98	0.46
5:G:228:ASP:HB3	5:G:364:TYR:CG	2.51	0.46
6:H:254:LYS:O	6:H:256:ASN:N	2.45	0.46
8:z:192:HIS:O	8:z:327:ARG:NH2	2.32	0.46
2:b:198:ILE:HD11	2:b:353:PHE:HE2	1.80	0.46
2:B:229:ALA:HA	2:B:282:ASN:HB2	1.97	0.46
3:D:48:ILE:HD11	3:D:64:ILE:HG23	1.98	0.46
3:D:232:ALA:HB1	3:D:284:ASN:HB2	1.98	0.46
3:D:382:ALA:HB3	3:D:386:ILE:HD12	1.98	0.46
3:D:418:GLU:HG2	3:D:450:ILE:HB	1.97	0.46
4:E:60:ILE:HG23	4:E:72:LYS:HE3	1.97	0.46
6:H:249:GLU:HB3	6:H:300:GLY:H	1.81	0.46
8:z:15:ARG:N	8:z:531:ASP:O	2.49	0.46
1:a:46:PRO:HG3	1:a:165:SER:HB3	1.97	0.46
1:a:205:VAL:HG11	1:a:399:GLU:HG3	1.97	0.46
1:a:289:ILE:HD11	1:a:309:GLU:HB3	1.98	0.46
1:A:255:ARG:HG2	5:G:256:GLU:HB3	1.97	0.46
2:B:286:ASN:ND2	2:B:288:GLN:O	2.48	0.46
3:d:186:SER:HB3	3:d:406:LYS:HA	1.97	0.46
5:g:5:VAL:C	5:g:7:PHE:H	2.22	0.46
5:g:72:HIS:HE1	5:g:74:ALA:HB3	1.81	0.46
8:z:230:ASN:HB2	8:z:291:LYS:HA	1.97	0.46
3:d:121:ALA:HB1	3:d:516:LYS:HG3	1.97	0.45
4:E:171:SER:HB2	4:E:175:LEU:HB2	1.98	0.45
5:g:96:VAL:HG22	5:g:569:SER:HA	1.97	0.45
6:h:194:LEU:HD13	6:h:401:LYS:HG3	1.98	0.45
6:h:232:GLN:NE2	6:h:312:ILE:O	2.49	0.45

Continued on next page...

Continued from previous page...

Atom-1	Atom-2	Interatomic distance (Å)	Clash overlap (Å)
6:H:86:ILE:HG22	7:Q:389:ALA:HB1	1.98	0.45
8:z:142:ASN:HD22	8:z:409:LYS:HG2	1.81	0.45
2:b:39:PRO:HA	2:b:163:SER:HA	1.99	0.45
3:d:173:LEU:HD12	3:d:209:MET:HE3	1.98	0.45
5:g:228:ASP:OD1	5:g:229:VAL:N	2.42	0.45
5:G:354:LEU:N	5:G:369:ASP:HB3	2.31	0.45
6:H:82:THR:HG21	6:H:517:ILE:HD11	1.99	0.45
8:Z:459:VAL:HG21	8:Z:469:VAL:HG21	1.98	0.45
1:a:67:ALA:HB2	1:a:98:THR:HG21	1.98	0.45
1:A:540:ARG:O	3:D:45:ASP:N	2.49	0.45
2:B:37:LEU:O	2:B:447:ASN:ND2	2.49	0.45
3:d:242:SER:HB2	3:d:243:PRO:HD2	1.97	0.45
4:e:243:VAL:HG22	4:e:353:HIS:CD2	2.50	0.45
6:H:104:LEU:HD11	6:H:446:LEU:HD23	1.97	0.45
7:q:13:LEU:HG	7:q:14:PHE:CD2	2.51	0.45
8:z:330:LEU:HB3	8:z:374:LYS:HB2	1.98	0.45
2:b:287:ARG:HA	2:b:309:ALA:HB3	1.98	0.45
6:h:356:GLN:HE21	6:h:359:SER:HA	1.81	0.45
6:h:378:LEU:HD11	6:h:393:LEU:HD12	1.98	0.45
6:H:360:GLU:OE1	6:H:362:TYR:OH	2.31	0.45
7:q:141:GLU:OE1	7:q:433:ARG:NH2	2.50	0.45
7:Q:547:ALA:HB3	8:Z:48:ASP:HA	1.98	0.45
2:b:5:ILE:O	4:e:97:ASP:N	2.49	0.45
2:b:66:SER:HB3	3:d:527:SER:HB2	1.99	0.45
2:b:343:ILE:HG13	2:b:356:PHE:CE1	2.51	0.45
3:d:14:LYS:O	3:d:17:PRO:HD2	2.17	0.45
5:g:39:LEU:O	5:g:519:ASN:ND2	2.49	0.45
6:h:245:ASN:HB2	6:h:336:SER:HB3	1.98	0.45
8:z:56:THR:HG21	8:z:61:VAL:HB	1.99	0.45
1:a:50:ASP:N	5:g:582:ARG:O	2.50	0.45
5:G:85:GLN:HB3	5:G:93:THR:HG22	1.99	0.45
6:H:30:ILE:HA	6:H:109:MET:HE2	1.99	0.45
1:A:495:ARG:HH21	1:A:498:ARG:NH2	2.15	0.45
2:b:251:LYS:HE3	3:d:253:ILE:HD12	1.98	0.45
2:B:445:ALA:HB1	2:B:450:PHE:HB2	1.99	0.45
4:e:546:ARG:HE	6:h:170:LEU:HD22	1.81	0.45
5:g:266:GLU:O	8:z:265:SER:OG	2.32	0.45
8:z:280:LEU:HD21	8:z:348:LEU:HD21	1.98	0.45
1:a:545:ILE:HB	3:d:48:ILE:HG12	1.99	0.45
2:b:167:SER:O	2:b:170:LYS:NZ	2.46	0.45
3:d:348:ASP:OD2	3:d:367:ARG:NH2	2.50	0.45

Continued on next page...

Continued from previous page...

Atom-1	Atom-2	Interatomic distance (Å)	Clash overlap (Å)
4:e:180:LEU:HD22	4:e:430:VAL:HG13	1.98	0.45
6:h:281:LYS:HB3	6:h:338:THR:HG21	1.98	0.45
6:H:43:THR:HB	6:H:64:ASN:HB2	1.99	0.45
7:q:321:LEU:HG	7:q:323:VAL:HG23	1.99	0.45
7:Q:228:PHE:HE2	7:Q:332:LEU:HD21	1.81	0.45
8:Z:508:ASP:OD1	8:Z:509:SER:N	2.50	0.45
2:B:45:LEU:HD21	3:D:73:PRO:HG2	1.99	0.45
2:B:80:ILE:HG21	2:B:504:ALA:HB2	1.98	0.45
4:e:177:ARG:NH2	4:e:202:GLU:OE1	2.50	0.45
4:e:219:VAL:HG11	4:e:431:ARG:HB2	1.99	0.45
4:E:74:LEU:N	4:E:82:THR:O	2.43	0.45
5:G:557:TYR:CE2	5:G:559:ILE:HB	2.51	0.45
6:h:261:VAL:HG21	6:h:270:ILE:HD13	1.98	0.45
7:q:22:SER:OG	7:q:25:ASP:OD2	2.35	0.45
8:z:83:GLN:O	8:z:87:THR:OG1	2.34	0.45
8:Z:297:ASN:OD1	8:Z:298:GLN:N	2.50	0.45
1:a:351:GLU:HG2	1:a:353:SER:H	1.82	0.44
2:b:516:ARG:HG2	4:e:75:ILE:HD13	1.99	0.44
3:D:256:ASP:HB3	3:D:259:GLN:HG3	1.97	0.44
4:e:207:ALA:HB1	4:e:404:VAL:HG21	1.98	0.44
4:e:557:SER:O	6:h:58:GLN:NE2	2.50	0.44
5:G:48:LEU:HD23	5:G:67:GLU:HB2	1.99	0.44
6:h:402:ARG:HB3	6:h:501:LEU:HD12	1.99	0.44
6:h:520:VAL:HG11	7:q:54:ILE:HG13	1.99	0.44
1:a:308:LYS:HD2	5:g:337:VAL:HG13	1.99	0.44
3:d:410:LEU:HD21	3:d:498:LEU:HD13	1.99	0.44
6:h:447:GLU:O	6:h:451:ARG:HG2	2.16	0.44
8:z:162:VAL:HG11	8:z:166:LEU:HD23	1.99	0.44
8:z:199:MET:SD	8:z:381:LYS:NZ	2.90	0.44
8:Z:22:ASN:HA	8:Z:72:THR:HG21	1.98	0.44
2:b:154:ILE:HG23	2:b:174:ALA:HB1	1.99	0.44
5:G:224:LEU:HD11	5:G:365:PHE:HB3	1.99	0.44
6:h:86:ILE:HG21	6:h:513:ALA:HB2	2.00	0.44
1:a:496:SER:OG	1:a:497:TYR:N	2.47	0.44
1:A:308:LYS:HD3	5:G:338:ASN:H	1.82	0.44
1:A:441:GLY:HA2	1:A:445:GLN:HB2	1.98	0.44
3:D:279:LYS:HD2	3:D:308:LEU:HD22	2.00	0.44
5:g:178:ALA:HB2	5:g:439:ILE:HD11	2.00	0.44
5:g:557:TYR:CD2	5:g:559:ILE:HG13	2.50	0.44
5:G:531:LEU:HD22	5:G:544:ILE:HD11	1.98	0.44
6:h:160:ARG:HD3	6:h:495:PHE:HB3	2.00	0.44

Continued on next page...

Continued from previous page...

Atom-1	Atom-2	Interatomic distance (Å)	Clash overlap (Å)
6:h:449:ILE:HB	6:h:450:PRO:HD3	1.99	0.44
8:Z:87:THR:HB	8:Z:512:VAL:HG22	1.99	0.44
4:e:382:GLU:HG2	4:e:391:ARG:HD2	1.98	0.44
4:E:34:ASP:HB3	4:E:37:ASN:HB2	1.99	0.44
5:G:51:PRO:HD3	8:Z:537:GLY:HA3	1.99	0.44
6:h:83:LEU:HD22	6:h:102:THR:HG23	1.99	0.44
7:q:24:ALA:O	8:Z:14:ARG:NH2	2.51	0.44
7:Q:492:THR:HB	7:Q:494:HIS:CD2	2.53	0.44
1:A:423:GLY:HA3	1:A:502:LEU:HD23	2.00	0.44
2:B:212:PHE:H	2:B:356:PHE:HB2	1.82	0.44
3:D:17:PRO:HB3	3:D:522:ASP:HB2	1.99	0.44
4:e:553:ASN:HB3	6:h:51:ILE:HG23	1.99	0.44
4:E:245:LEU:HD11	4:E:354:ILE:HD11	1.99	0.44
4:E:448:VAL:HG21	4:E:498:LEU:HD13	2.00	0.44
5:G:306:GLN:HE21	8:Z:338:ASN:HD21	1.66	0.44
6:h:5:SER:OG	6:h:6:GLN:OE1	2.33	0.44
6:h:90:GLN:O	6:h:95:GLY:N	2.50	0.44
8:Z:39:PRO:HA	8:Z:160:THR:HA	1.97	0.44
4:e:243:VAL:HB	4:e:395:ILE:HD12	2.00	0.44
5:g:236:ARG:HB3	5:g:357:VAL:HB	1.98	0.44
5:g:296:ILE:HG23	5:g:320:VAL:HG21	1.99	0.44
6:h:93:GLU:OE1	7:q:215:GLY:N	2.51	0.44
6:H:170:LEU:HG	6:H:171:ILE:HG23	1.98	0.44
7:q:336:CYS:HB2	7:q:353:GLY:HA3	1.98	0.44
3:D:419:ILE:HG13	3:D:469:LEU:HD13	1.99	0.44
4:E:115:ILE:HG21	4:E:533:GLY:HA2	2.00	0.44
4:E:192:ILE:HG12	4:E:193:VAL:HG23	2.00	0.44
5:g:21:GLN:NE2	5:g:583:VAL:O	2.51	0.44
5:G:205:ARG:NE	5:G:207:GLU:HB2	2.33	0.44
6:h:8:PRO:HA	8:Z:4:GLN:HG2	2.00	0.44
6:H:261:VAL:HG21	6:H:270:ILE:HG13	2.00	0.44
7:Q:205:ASP:HB3	7:Q:331:ARG:HH21	1.82	0.44
8:Z:243:GLU:HG2	8:Z:244:LYS:H	1.83	0.44
2:B:68:PRO:HD3	3:D:528:ARG:HG3	2.00	0.44
4:E:136:LEU:HB3	4:E:141:ILE:HD12	2.00	0.44
4:E:438:ARG:HD2	4:E:531:PHE:CD2	2.52	0.44
7:q:284:ILE:HG23	7:q:312:TYR:HE2	1.82	0.44
7:q:463:LEU:HB3	7:q:501:ILE:HD11	2.00	0.44
8:z:68:ILE:HG21	8:z:73:ALA:HB3	1.99	0.44
1:A:37:ALA:O	1:A:41:LYS:HG3	2.18	0.43
1:A:387:LEU:HD22	1:A:398:MET:HE2	2.00	0.43

Continued on next page...

Continued from previous page...

Atom-1	Atom-2	Interatomic distance (Å)	Clash overlap (Å)
2:b:285:ILE:HG13	2:b:306:ILE:HB	1.99	0.43
4:e:51:ILE:HG21	4:e:134:LEU:HB2	2.00	0.43
6:H:13:LEU:HD13	6:H:17:THR:HG21	2.00	0.43
6:H:90:GLN:HB3	6:H:98:THR:HG22	2.00	0.43
7:q:72:LEU:HD13	7:q:86:VAL:HG22	1.99	0.43
8:Z:136:PHE:HE2	8:Z:412:ILE:HG23	1.81	0.43
8:Z:497:ASP:OD1	8:Z:498:SER:N	2.44	0.43
1:a:390:ALA:O	5:g:84:THR:OG1	2.35	0.43
1:a:460:LYS:HG2	1:a:474:VAL:HG21	2.00	0.43
2:b:85:ASP:HA	2:b:89:GLY:HA2	2.00	0.43
4:E:157:ALA:HB1	4:E:450:MET:HB3	2.00	0.43
5:g:45:LEU:HD23	5:g:59:ASN:HB3	1.99	0.43
5:G:451:GLU:OE1	5:G:454:ARG:NH2	2.51	0.43
6:h:229:PHE:CG	6:h:230:GLU:N	2.86	0.43
6:H:91:ASP:HA	6:H:95:GLY:HA2	2.01	0.43
6:H:147:ILE:HG21	6:H:409:ILE:HD12	1.99	0.43
7:Q:509:VAL:HG12	7:Q:509:VAL:O	2.18	0.43
1:a:155:THR:O	1:a:159:ILE:HG12	2.17	0.43
1:a:156:LEU:HD22	1:a:409:VAL:HG13	1.99	0.43
1:A:525:VAL:C	1:A:527:SER:H	2.26	0.43
2:B:262:GLU:HB2	3:D:246:PRO:HG3	2.00	0.43
3:d:91:ASP:OD1	3:d:92:GLY:N	2.51	0.43
3:D:410:LEU:HA	3:D:501:VAL:HG23	2.00	0.43
5:G:441:LEU:HD21	5:G:452:ILE:HB	1.98	0.43
7:q:23:ASN:C	7:q:25:ASP:H	2.26	0.43
1:a:248:ASP:HB2	1:a:339:SER:HA	1.99	0.43
1:a:334:GLY:HA3	1:a:379:LYS:HG3	2.00	0.43
2:b:287:ARG:HH11	2:b:311:PHE:HE1	1.67	0.43
3:d:113:LYS:HG2	4:E:481:MET:HE1	1.99	0.43
5:G:59:ASN:HD21	5:G:162:LYS:HD3	1.82	0.43
7:Q:348:THR:HG22	7:Q:350:GLU:H	1.83	0.43
1:a:11:ASP:C	1:a:13:LEU:H	2.26	0.43
1:A:471:SER:HB3	6:h:120:ILE:HD11	2.00	0.43
2:B:200:GLY:HA2	3:D:84:ALA:HB1	2.00	0.43
2:B:250:PHE:HE2	3:D:248:THR:HB	1.83	0.43
6:H:91:ASP:HB2	6:H:98:THR:HG21	1.99	0.43
7:q:171:LYS:HG3	7:q:397:ILE:HG12	2.01	0.43
8:Z:33:LEU:HD12	8:Z:95:VAL:HG11	1.99	0.43
5:G:456:LEU:HB3	5:G:460:MET:HE2	2.01	0.43
7:Q:284:ILE:HG21	7:Q:309:ALA:HA	2.00	0.43
8:z:201:HIS:CE1	8:z:202:LEU:HG	2.54	0.43

Continued on next page...

Continued from previous page...

Atom-1	Atom-2	Interatomic distance (Å)	Clash overlap (Å)
8:z:217:HIS:O	8:z:365:THR:OG1	2.29	0.43
8:z:497:ASP:OD1	8:z:498:SER:N	2.44	0.43
4:E:502:GLN:HE22	4:E:508:SER:HA	1.84	0.43
6:H:18:ASP:OD1	6:H:19:ALA:N	2.43	0.43
8:Z:130:MET:SD	8:Z:514:ARG:NH1	2.92	0.43
1:a:391:ASN:OD1	1:a:394:SER:N	2.46	0.43
2:b:46:LEU:HD13	2:b:66:SER:HB2	2.00	0.43
2:B:251:LYS:HB2	4:E:288:ASP:HB3	2.01	0.43
4:e:309:MET:HE2	4:e:366:PHE:HE2	1.84	0.43
2:B:244:LYS:NZ	4:E:302:GLU:OE2	2.36	0.43
2:B:248:THR:HA	4:E:287:LEU:HB3	2.00	0.43
4:e:556:ILE:HA	6:h:54:VAL:HB	2.00	0.43
4:E:38:LYS:HG2	4:E:557:SER:HA	2.00	0.43
4:E:479:ILE:HB	4:E:480:PRO:HD3	2.01	0.43
6:H:85:ASP:HB3	7:Q:390:THR:HA	2.01	0.43
7:Q:117:LEU:HD21	7:Q:451:GLN:HG3	2.00	0.43
7:Q:336:CYS:HB2	7:Q:353:GLY:HA3	2.00	0.43
7:Q:475:LEU:HB3	7:Q:476:PRO:HD3	2.01	0.43
8:z:384:THR:HG21	8:z:386:TYR:CZ	2.53	0.43
8:Z:22:ASN:ND2	8:Z:527:LEU:O	2.52	0.43
1:A:120:ILE:HG23	1:A:125:ILE:HD11	2.01	0.43
2:B:191:GLU:O	2:B:316:ARG:NE	2.34	0.43
3:d:407:GLU:HG3	3:d:409:GLY:H	1.84	0.43
5:G:210:PRO:HA	5:G:449:LEU:HD11	2.01	0.43
8:z:356:GLN:HG2	8:z:365:THR:HA	2.00	0.43
8:Z:356:GLN:HG2	8:Z:365:THR:HA	2.01	0.43
2:b:76:VAL:HG22	4:e:414:MET:HE1	2.01	0.42
3:D:288:ILE:HG21	3:D:296:ALA:HB1	2.00	0.42
4:e:110:SER:OG	6:h:381:GLY:O	2.28	0.42
4:e:213:ASP:C	4:e:215:ASP:H	2.26	0.42
4:e:219:VAL:HG21	4:e:431:ARG:HB3	2.01	0.42
6:H:236:PHE:HB2	6:H:352:PHE:HB3	2.00	0.42
8:Z:469:VAL:HG23	8:Z:470:LEU:HD12	2.00	0.42
1:a:493:LYS:C	1:a:495:ARG:H	2.26	0.42
1:A:93:GLU:HG2	3:D:356:ASP:HB3	2.01	0.42
2:B:88:VAL:O	2:B:389:SER:OG	2.31	0.42
2:B:243:VAL:HG12	2:B:244:LYS:H	1.84	0.42
5:G:554:MET:HA	5:G:557:TYR:HB3	2.01	0.42
6:h:450:PRO:HA	6:h:453:LEU:HD12	2.00	0.42
1:a:231:GLN:O	5:g:330:ARG:NH2	2.52	0.42
1:A:545:ILE:HB	3:D:48:ILE:HG12	2.02	0.42

Continued on next page...

Continued from previous page...

Atom-1	Atom-2	Interatomic distance (Å)	Clash overlap (Å)
2:b:249:LYS:NZ	3:d:251:ASN:HD22	2.18	0.42
2:B:39:PRO:HA	2:B:163:SER:HA	2.01	0.42
5:G:222:GLY:HA2	5:G:331:VAL:HG21	2.01	0.42
8:z:420:ILE:HD13	8:z:473:VAL:HG11	2.01	0.42
1:A:327:ARG:HH22	3:D:222:SER:HA	1.85	0.42
2:B:243:VAL:HG12	2:B:244:LYS:N	2.35	0.42
3:d:183:ASP:OD1	3:d:184:GLU:N	2.52	0.42
3:D:229:LYS:HE2	3:D:284:ASN:HB3	2.00	0.42
4:E:110:SER:OG	6:H:207:GLY:N	2.51	0.42
8:z:218:GLY:HA3	8:z:363:LYS:HB2	2.01	0.42
8:Z:226:THR:HG23	8:Z:356:GLN:HB2	2.00	0.42
2:b:206:SER:OG	2:b:368:VAL:O	2.34	0.42
2:B:167:SER:O	2:B:170:LYS:NZ	2.40	0.42
2:B:183:ARG:HB3	2:B:362:GLY:O	2.19	0.42
3:d:171:ALA:HB3	3:d:172:PRO:HD3	2.02	0.42
5:g:221:LYS:HD3	5:g:370:ASN:HD21	1.85	0.42
5:g:585:ASP:OD1	5:g:586:ILE:N	2.52	0.42
6:H:46:PRO:HA	6:H:168:SER:H	1.84	0.42
6:H:485:THR:C	6:H:487:ASN:H	2.28	0.42
7:Q:48:PRO:HA	7:Q:169:SER:HA	2.01	0.42
8:z:128:GLU:HB3	8:z:425:TYR:HE2	1.85	0.42
8:Z:126:ARG:O	8:Z:129:SER:OG	2.30	0.42
1:a:25:ILE:HD12	1:a:544:MET:HB3	2.02	0.42
2:b:189:ASN:OD1	2:b:190:LEU:N	2.53	0.42
2:b:413:LYS:HD2	2:b:463:ILE:HG22	2.01	0.42
3:D:85:GLN:NE2	3:D:506:SER:OG	2.43	0.42
5:g:263:ILE:HG23	5:g:268:ASP:HB2	2.02	0.42
6:H:525:THR:HA	7:Q:56:VAL:HB	2.00	0.42
7:Q:5:LEU:HD21	8:z:535:ARG:HB2	2.01	0.42
8:z:13:LEU:O	8:z:532:GLU:HA	2.20	0.42
2:b:20:LEU:H	2:b:23:PHE:HD2	1.67	0.42
5:g:89:VAL:HG11	5:g:565:ILE:HG12	2.01	0.42
6:h:477:LYS:HG3	6:h:478:TRP:CE3	2.55	0.42
6:h:522:GLU:HB3	7:q:53:LYS:HD2	2.02	0.42
7:q:333:CYS:SG	7:q:340:PRO:HG3	2.60	0.42
1:A:251:LEU:HB2	1:A:302:ILE:HG23	2.01	0.42
2:b:34:LYS:HG3	2:b:443:ILE:HD13	2.02	0.42
2:b:312:GLU:OE1	2:b:316:ARG:NH2	2.52	0.42
2:B:109:LEU:HA	2:B:113:SER:HB2	2.02	0.42
2:B:232:LEU:HD21	2:B:329:PHE:HE1	1.83	0.42
2:B:413:LYS:HG3	2:B:464:TYR:HE1	1.85	0.42

Continued on next page...

Continued from previous page...

Atom-1	Atom-2	Interatomic distance (Å)	Clash overlap (Å)
3:d:70:ILE:HG22	3:d:72:HIS:H	1.85	0.42
3:d:213:VAL:HG13	3:d:323:PHE:CE2	2.55	0.42
6:h:37:GLN:O	6:h:41:LYS:HG3	2.20	0.42
6:H:89:ALA:HB1	7:Q:214:GLY:HA2	2.01	0.42
8:z:170:LEU:HD23	8:z:173:ILE:HD12	2.02	0.42
3:D:240:GLN:NE2	3:D:291:SER:OG	2.53	0.42
5:G:25:ILE:HG12	5:G:104:LEU:HG	2.01	0.42
6:H:125:ILE:HA	6:H:438:ILE:HD13	2.02	0.42
7:q:230:ARG:HG3	7:q:321:LEU:HD11	2.01	0.42
7:Q:20:SER:OG	7:Q:543:GLN:NE2	2.53	0.42
8:Z:147:ARG:NH2	8:Z:176:ASP:OD1	2.44	0.42
8:Z:405:VAL:HG22	8:Z:411:ILE:HD13	2.02	0.42
1:A:46:PRO:HD2	1:A:504:LEU:HD12	2.02	0.42
1:A:67:ALA:HB2	1:A:98:THR:HG21	2.02	0.42
1:A:157:ILE:HG23	1:A:177:SER:HB2	2.01	0.42
5:G:275:ILE:O	5:G:279:GLN:N	2.40	0.42
6:H:242:LEU:HD21	6:H:341:ILE:HD13	2.01	0.42
7:q:184:GLU:OE2	7:q:188:HIS:NE2	2.52	0.42
1:a:165:SER:O	1:a:166:SER:OG	2.32	0.41
1:a:209:HIS:HB3	5:g:84:THR:HG23	2.02	0.41
1:A:216:SER:OG	1:A:386:ILE:O	2.28	0.41
3:d:237:ILE:HD13	3:d:241:ILE:HD11	2.02	0.41
3:D:167:SER:HA	3:D:170:LEU:HB2	2.01	0.41
5:G:211:GLY:HA3	8:Z:86:ILE:HD13	2.00	0.41
5:G:219:VAL:HG22	5:G:439:ILE:HG12	2.02	0.41
6:h:53:ILE:HD11	6:h:69:ILE:HG23	2.02	0.41
3:D:274:ILE:HG23	3:D:336:ILE:HD13	2.02	0.41
4:e:147:ALA:HB1	4:e:546:ARG:HG3	2.03	0.41
4:E:64:SER:HB2	4:E:85:ASN:HB2	2.01	0.41
5:G:500:TRP:HB2	5:G:501:PRO:HD3	2.02	0.41
7:q:24:ALA:H	7:q:28:ILE:HD12	1.84	0.41
7:q:223:ILE:HG23	7:q:372:LYS:HB2	2.02	0.41
8:z:86:ILE:HG13	8:z:87:THR:N	2.35	0.41
5:G:58:THR:HB	5:G:454:ARG:HH21	1.84	0.41
7:q:434:ILE:HB	7:q:453:ALA:HB2	2.03	0.41
8:z:368:THR:HG23	8:z:369:GLU:HG2	2.01	0.41
1:A:165:SER:O	1:A:166:SER:OG	2.32	0.41
2:b:268:LYS:HD2	4:e:299:GLN:HE21	1.84	0.41
2:B:27:ILE:HG12	2:B:104:ARG:HD3	2.02	0.41
4:E:266:GLY:HA3	4:E:376:THR:HG23	2.02	0.41
5:G:242:ARG:NH1	5:G:290:VAL:O	2.40	0.41

Continued on next page...

Continued from previous page...

Atom-1	Atom-2	Interatomic distance (Å)	Clash overlap (Å)
5:G:370:ASN:OD1	5:G:371:CYS:N	2.52	0.41
7:q:239:LEU:CD2	7:q:240:SER:H	2.28	0.41
7:Q:142:LEU:HD21	7:Q:430:LEU:HD11	2.01	0.41
8:Z:204:PRO:HG3	8:Z:382:GLY:HA2	2.01	0.41
2:B:77:LEU:HD23	2:B:96:THR:HG23	2.03	0.41
3:d:86:ASP:HA	3:d:90:GLY:HA2	2.02	0.41
4:E:320:VAL:HG22	4:E:341:PRO:HB2	2.03	0.41
5:G:42:LYS:HE3	5:G:547:ASP:HA	2.03	0.41
6:h:225:SER:HB2	6:h:229:PHE:CG	2.55	0.41
6:H:239:PRO:HG3	6:H:352:PHE:HB2	2.02	0.41
8:Z:329:GLN:HE21	8:Z:336:ALA:N	2.18	0.41
1:a:89:GLN:HE22	3:d:382:ALA:HA	1.86	0.41
1:a:90:GLN:HE21	1:a:94:ILE:HB	1.86	0.41
2:b:243:VAL:HG21	4:e:289:ILE:HD12	2.02	0.41
5:g:74:ALA:HB1	5:g:580:LEU:HD22	2.02	0.41
5:g:230:VAL:O	8:z:322:ARG:NH2	2.54	0.41
8:z:87:THR:HB	8:z:512:VAL:HG22	2.01	0.41
8:z:460:LYS:NZ	8:Z:110:GLN:O	2.44	0.41
3:d:154:ALA:HA	3:d:400:VAL:HG11	2.03	0.41
4:e:314:LYS:HD3	4:e:340:LEU:HD11	2.01	0.41
4:E:267:VAL:HG22	4:E:377:CYS:H	1.86	0.41
5:g:72:HIS:CE1	5:g:74:ALA:HB3	2.55	0.41
5:G:91:ASP:OD2	5:G:158:SER:OG	2.38	0.41
5:G:371:CYS:C	5:G:373:GLU:H	2.28	0.41
6:h:204:ILE:HG12	6:h:362:TYR:CE2	2.55	0.41
6:H:260:ARG:HH21	7:Q:266:LEU:HD13	1.86	0.41
7:q:67:ASP:OD1	7:q:100:THR:OG1	2.27	0.41
7:q:420:LEU:N	7:q:519:ASP:O	2.53	0.41
8:z:63:LEU:HD13	8:z:77:ALA:HA	2.01	0.41
8:z:294:VAL:HG22	8:z:315:LEU:HB3	2.02	0.41
1:a:37:ALA:O	1:a:41:LYS:HG3	2.21	0.41
1:a:192:SER:HB2	1:a:195:GLU:HB3	2.03	0.41
1:A:46:PRO:HG3	1:A:165:SER:HB2	2.03	0.41
2:b:167:SER:HA	2:b:170:LYS:HD3	2.02	0.41
4:E:31:ILE:HG22	4:E:32:VAL:HG23	2.03	0.41
5:G:113:GLU:HG2	7:q:461:ARG:NH1	2.35	0.41
6:h:248:LEU:O	6:h:300:GLY:N	2.54	0.41
6:H:401:LYS:NZ	7:Q:362:GLU:OE1	2.49	0.41
1:a:19:LYS:HE2	1:a:543:THR:HG21	2.03	0.41
1:a:270:LEU:HD13	5:g:261:ILE:HD11	2.03	0.41
1:A:15:LEU:HB3	3:D:69:ALA:HB3	2.02	0.41

Continued on next page...

Continued from previous page...

Atom-1	Atom-2	Interatomic distance (Å)	Clash overlap (Å)
1:A:25:ILE:HD12	1:A:544:MET:HB3	2.03	0.41
1:A:506:ARG:HH21	1:A:510:VAL:HG21	1.86	0.41
2:b:19:ARG:O	2:b:20:LEU:HB3	2.20	0.41
3:d:278:ILE:HG23	3:d:283:CYS:HB3	2.02	0.41
3:d:305:LEU:HD13	3:d:312:VAL:HG21	2.03	0.41
3:D:463:ILE:HG23	4:e:467:TYR:HE2	1.86	0.41
4:e:158:ILE:HG21	4:e:535:LYS:HE3	2.03	0.41
6:h:64:ASN:HB3	6:h:169:LYS:NZ	2.35	0.41
7:Q:300:VAL:HG22	7:Q:321:LEU:HD23	2.03	0.41
7:Q:486:GLU:HA	7:Q:487:PRO:HD3	1.85	0.41
8:z:16:ASP:HA	8:z:19:LEU:HB3	2.03	0.41
1:A:379:LYS:HG2	1:A:380:HIS:CD2	2.56	0.41
2:b:320:VAL:HG23	2:b:364:ALA:HB3	2.03	0.41
3:d:158:LEU:O	3:d:161:LYS:HG2	2.20	0.41
3:D:483:SER:HB3	3:D:486:ARG:HB2	2.02	0.41
4:e:278:PRO:HA	4:e:279:PRO:HD3	1.98	0.41
4:E:448:VAL:HG11	4:E:498:LEU:HB3	2.03	0.41
5:G:249:PRO:HB3	5:G:299:LYS:HB2	2.02	0.41
6:h:342:LYS:HB2	6:h:345:HIS:CD2	2.55	0.41
1:a:64:ASN:HD21	1:a:166:SER:HB2	1.84	0.40
1:a:180:VAL:HG13	1:a:406:LEU:HD23	2.03	0.40
4:e:86:ASP:OD1	4:e:119:THR:OG1	2.38	0.40
4:E:385:PHE:CE2	4:E:392:MET:HB2	2.55	0.40
5:g:471:SER:OG	5:g:563:GLU:OE1	2.36	0.40
5:g:525:ILE:HD13	7:Q:122:LEU:HD23	2.03	0.40
6:h:201:ILE:HG21	6:h:378:LEU:HD12	2.02	0.40
6:h:243:SER:CB	6:h:334:ILE:HG12	2.51	0.40
7:q:189:VAL:HB	7:q:380:ARG:HA	2.03	0.40
7:q:284:ILE:HD12	7:q:287:MET:HE3	2.03	0.40
7:Q:547:ALA:C	7:Q:549:LYS:H	2.29	0.40
8:z:412:ILE:HD11	8:z:510:TYR:HD1	1.86	0.40
8:Z:15:ARG:HG3	8:Z:16:ASP:H	1.86	0.40
1:A:54:VAL:HB	5:G:588:SER:HA	2.02	0.40
1:A:295:VAL:HG21	1:A:361:VAL:HG11	2.03	0.40
2:B:258:LEU:HG	3:D:244:PRO:HB2	2.03	0.40
3:d:232:ALA:HB1	3:d:284:ASN:HB2	2.02	0.40
4:E:86:ASP:OD1	4:E:119:THR:OG1	2.31	0.40
7:Q:155:ASP:OD1	7:Q:156:LYS:N	2.53	0.40
7:Q:239:LEU:HD12	7:Q:358:VAL:HB	2.03	0.40
1:a:308:LYS:NZ	5:g:342:ASP:OD2	2.54	0.40
1:A:33:THR:HG23	1:A:83:LEU:HD11	2.01	0.40

Continued on next page...

Continued from previous page...

Atom-1	Atom-2	Interatomic distance (Å)	Clash overlap (Å)
2:B:192:HIS:HA	2:B:316:ARG:HG2	2.03	0.40
2:B:231:ILE:HD11	2:B:343:ILE:HD11	2.03	0.40
2:B:236:THR:HG23	2:B:237:THR:HG22	2.04	0.40
3:d:463:ILE:HD11	4:E:141:ILE:HD11	2.03	0.40
3:D:85:GLN:HG2	3:D:93:THR:HA	2.03	0.40
4:E:438:ARG:HB3	4:E:531:PHE:HB3	2.03	0.40
7:Q:284:ILE:HG22	7:Q:312:TYR:HD2	1.86	0.40
8:Z:204:PRO:HG3	8:Z:383:SER:H	1.87	0.40
2:b:77:LEU:HD23	2:b:96:THR:HG23	2.04	0.40
2:b:510:ARG:HA	4:e:70:LEU:HD22	2.03	0.40
2:B:438:ARG:HH11	2:B:460:ARG:CZ	2.34	0.40
3:D:148:GLU:O	3:D:152:ARG:NE	2.41	0.40
5:g:545:ASP:OD1	5:g:546:GLY:N	2.55	0.40
6:h:30:ILE:HG23	6:h:109:MET:HB3	2.03	0.40
6:H:195:ASP:HA	7:Q:367:ARG:NH2	2.36	0.40
7:q:325:SER:HB2	7:q:328:GLU:HG2	2.03	0.40
8:z:46:LEU:HD11	8:z:62:LEU:HD23	2.02	0.40
1:a:38:ASN:C	5:g:14:ARG:HH12	2.30	0.40
3:d:194:ILE:HG12	3:d:375:VAL:HB	2.03	0.40
4:e:107:LEU:HD21	4:e:122:VAL:HG12	2.04	0.40
4:E:158:ILE:HG21	4:E:535:LYS:HE3	2.03	0.40
6:H:77:HIS:HE1	6:H:79:ALA:HB3	1.87	0.40
6:H:244:LEU:HB3	6:H:246:VAL:HG22	2.04	0.40
7:q:18:TYR:HD1	7:q:547:ALA:HA	1.87	0.40

There are no symmetry-related clashes.

5.3 Torsion angles [i](#)

5.3.1 Protein backbone [i](#)

In the following table, the Percentiles column shows the percent Ramachandran outliers of the chain as a percentile score with respect to all PDB entries followed by that with respect to all EM entries.

The Analysed column shows the number of residues for which the backbone conformation was analysed, and the total number of residues.

Mol	Chain	Analysed	Favoured	Allowed	Outliers	Percentiles
1	A	548/559 (98%)	528 (96%)	19 (4%)	1 (0%)	43 72

Continued on next page...

Continued from previous page...

Mol	Chain	Analysed	Favoured	Allowed	Outliers	Percentiles	
1	a	542/559 (97%)	510 (94%)	32 (6%)	0	100	100
2	B	516/527 (98%)	499 (97%)	16 (3%)	1 (0%)	43	72
2	b	516/527 (98%)	503 (98%)	13 (2%)	0	100	100
3	D	521/528 (99%)	500 (96%)	20 (4%)	1 (0%)	43	72
3	d	522/528 (99%)	503 (96%)	18 (3%)	1 (0%)	43	72
4	E	534/562 (95%)	514 (96%)	19 (4%)	1 (0%)	43	72
4	e	533/562 (95%)	521 (98%)	12 (2%)	0	100	100
5	G	514/594 (86%)	501 (98%)	13 (2%)	0	100	100
5	g	514/594 (86%)	502 (98%)	11 (2%)	1 (0%)	43	72
6	H	516/550 (94%)	494 (96%)	20 (4%)	2 (0%)	30	61
6	h	525/550 (96%)	506 (96%)	18 (3%)	1 (0%)	43	72
7	Q	546/568 (96%)	516 (94%)	28 (5%)	2 (0%)	30	61
7	q	537/568 (94%)	511 (95%)	24 (4%)	2 (0%)	30	61
8	Z	536/546 (98%)	522 (97%)	13 (2%)	1 (0%)	43	72
8	z	536/546 (98%)	518 (97%)	18 (3%)	0	100	100
All	All	8456/8868 (95%)	8148 (96%)	294 (4%)	14 (0%)	44	72

All (14) Ramachandran outliers are listed below:

Mol	Chain	Res	Type
3	D	163	VAL
5	g	6	VAL
7	q	29	ILE
6	H	171	ILE
8	Z	247	VAL
1	A	492	VAL
2	B	243	VAL
7	Q	192	VAL
4	E	262	GLU
6	H	255	ASP
6	h	230	GLU
7	q	28	ILE
7	Q	509	VAL
3	d	189	VAL

5.3.2 Protein sidechains [i](#)

In the following table, the Percentiles column shows the percent sidechain outliers of the chain as a percentile score with respect to all PDB entries followed by that with respect to all EM entries.

The Analysed column shows the number of residues for which the sidechain conformation was analysed, and the total number of residues.

Mol	Chain	Analysed	Rotameric	Outliers	Percentiles	
1	A	462/471 (98%)	462 (100%)	0	100	100
1	a	458/471 (97%)	458 (100%)	0	100	100
2	B	433/441 (98%)	433 (100%)	0	100	100
2	b	433/441 (98%)	433 (100%)	0	100	100
3	D	449/453 (99%)	449 (100%)	0	100	100
3	d	450/453 (99%)	450 (100%)	0	100	100
4	E	461/483 (95%)	461 (100%)	0	100	100
4	e	460/483 (95%)	460 (100%)	0	100	100
5	G	443/501 (88%)	443 (100%)	0	100	100
5	g	443/501 (88%)	443 (100%)	0	100	100
6	H	434/454 (96%)	434 (100%)	0	100	100
6	h	440/454 (97%)	440 (100%)	0	100	100
7	Q	458/473 (97%)	458 (100%)	0	100	100
7	q	453/473 (96%)	453 (100%)	0	100	100
8	Z	455/463 (98%)	455 (100%)	0	100	100
8	z	455/463 (98%)	455 (100%)	0	100	100
All	All	7187/7478 (96%)	7187 (100%)	0	100	100

There are no protein residues with a non-rotameric sidechain to report.

Sometimes sidechains can be flipped to improve hydrogen bonding and reduce clashes. All (106) such sidechains are listed below:

Mol	Chain	Res	Type
1	a	64	ASN
1	a	89	GLN
1	a	90	GLN
1	a	190	GLN
1	a	269	GLN
1	a	380	HIS

Continued on next page...

Continued from previous page...

Mol	Chain	Res	Type
1	a	430	ASN
1	A	7	ASN
1	A	90	GLN
1	A	261	GLN
1	A	263	ASN
1	A	363	GLN
1	A	485	GLN
2	b	4	GLN
2	b	144	HIS
2	b	221	ASN
2	b	351	GLN
2	B	118	GLN
2	B	168	GLN
2	B	286	ASN
2	B	288	GLN
2	B	304	ASN
2	B	351	GLN
3	d	8	ASN
3	d	67	GLN
3	d	85	GLN
3	d	149	GLN
3	d	188	ASN
3	d	303	HIS
3	d	496	HIS
3	d	499	GLN
3	D	85	GLN
3	D	240	GLN
3	D	303	HIS
3	D	395	HIS
4	e	41	GLN
4	e	197	HIS
4	e	299	GLN
4	e	337	GLN
4	e	397	GLN
4	e	424	HIS
4	E	35	GLN
4	E	93	GLN
4	E	253	GLN
4	E	337	GLN
4	E	353	HIS
4	E	397	GLN
4	E	502	GLN

Continued on next page...

Continued from previous page...

Mol	Chain	Res	Type
4	E	537	GLN
4	E	543	GLN
5	g	21	GLN
5	g	85	GLN
5	g	325	ASN
5	G	166	HIS
5	G	270	ASN
5	G	306	GLN
5	G	465	ASN
6	h	64	ASN
6	h	90	GLN
6	h	238	ASN
6	h	268	GLN
6	h	291	ASN
6	h	305	GLN
6	h	328	GLN
6	h	345	HIS
6	h	356	GLN
6	h	472	HIS
6	h	508	ASN
6	h	526	ASN
6	H	6	GLN
6	H	37	GLN
6	H	90	GLN
6	H	174	ASN
6	H	216	ASN
6	H	263	HIS
6	H	291	ASN
6	H	345	HIS
6	H	356	GLN
6	H	366	GLN
6	H	384	GLN
6	H	435	GLN
7	q	27	GLN
7	q	283	GLN
7	q	373	GLN
7	q	375	GLN
7	Q	92	GLN
7	Q	219	ASN
7	Q	283	GLN
7	Q	494	HIS
8	z	69	GLN

Continued on next page...

Continued from previous page...

Mol	Chain	Res	Type
8	z	192	HIS
8	z	230	ASN
8	z	298	GLN
8	z	312	HIS
8	z	329	GLN
8	z	338	ASN
8	z	356	GLN
8	z	370	ASN
8	z	404	ASN
8	Z	7	ASN
8	Z	83	GLN
8	Z	230	ASN
8	Z	329	GLN
8	Z	370	ASN
8	Z	385	HIS
8	Z	410	ASN

5.3.3 RNA [i](#)

There are no RNA molecules in this entry.

5.4 Non-standard residues in protein, DNA, RNA chains [i](#)

There are no non-standard protein/DNA/RNA residues in this entry.

5.5 Carbohydrates [i](#)

There are no oligosaccharides in this entry.

5.6 Ligand geometry [i](#)

There are no ligands in this entry.

5.7 Other polymers [i](#)

There are no such residues in this entry.

5.8 Polymer linkage issues

There are no chain breaks in this entry.

6 Map visualisation [i](#)

This section contains visualisations of the EMDB entry EMD-45889. These allow visual inspection of the internal detail of the map and identification of artifacts.

No raw map or half-maps were deposited for this entry and therefore no images, graphs, etc. pertaining to the raw map can be shown.

6.1 Orthogonal projections [i](#)

6.1.1 Primary map

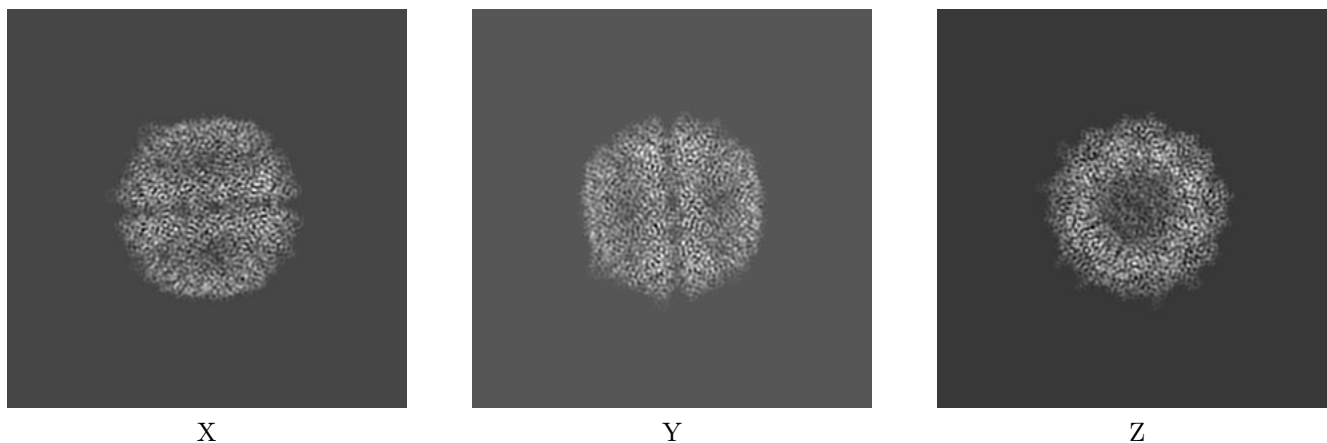

The images above show the map projected in three orthogonal directions.

6.2 Central slices [i](#)

6.2.1 Primary map

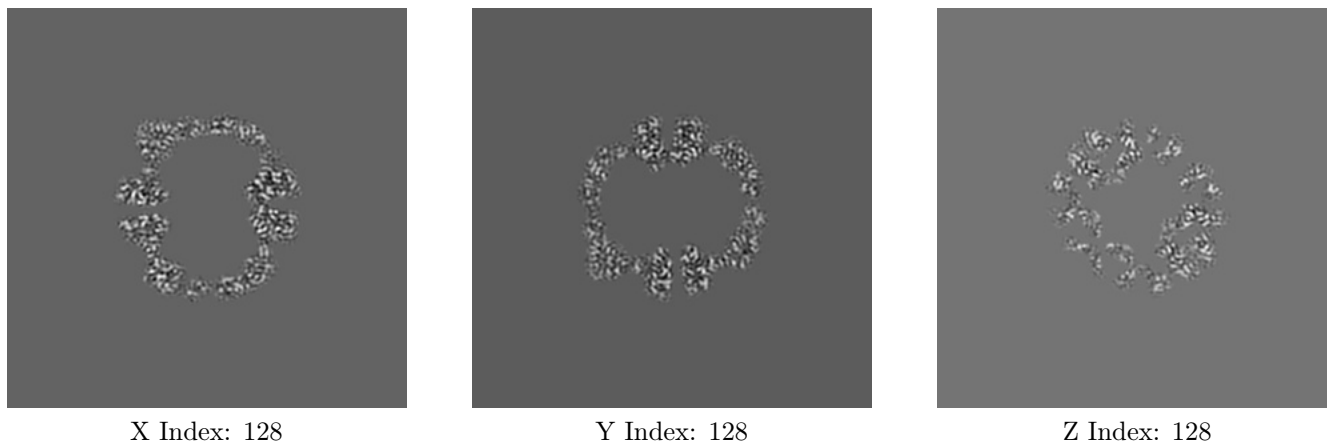

The images above show central slices of the map in three orthogonal directions.

6.3 Largest variance slices [\(i\)](#)

6.3.1 Primary map



X Index: 153

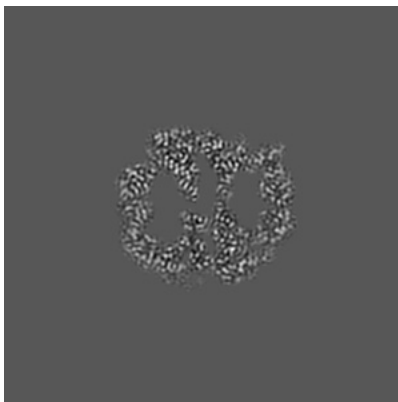

Y Index: 152

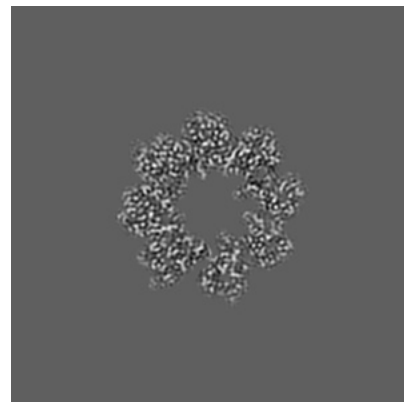

Z Index: 140

The images above show the largest variance slices of the map in three orthogonal directions.

6.4 Orthogonal standard-deviation projections (False-color) [\(i\)](#)

6.4.1 Primary map

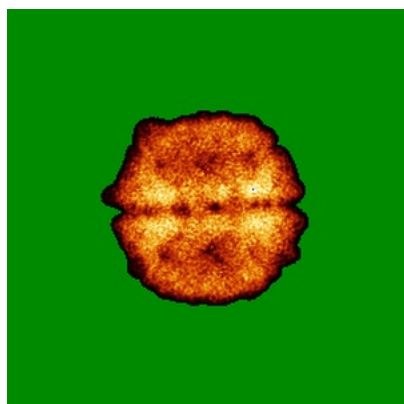

X

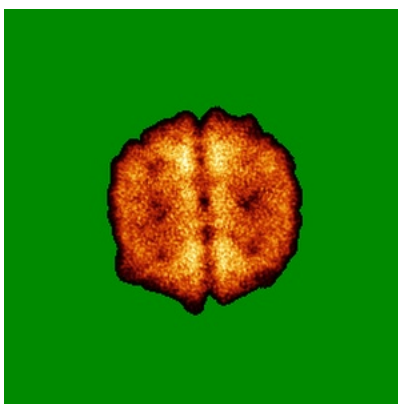

Y

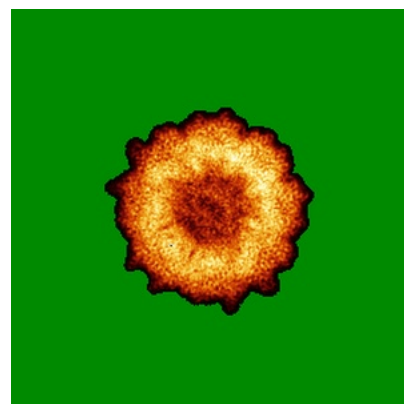

Z

The images above show the map standard deviation projections with false color in three orthogonal directions. Minimum values are shown in green, max in blue, and dark to light orange shades represent small to large values respectively.

6.5 Orthogonal surface views

This section was not generated.

6.6 Mask visualisation

This section was not generated. No masks/segmentation were deposited.

7 Map analysis [i](#)

This section contains the results of statistical analysis of the map.

7.1 Map-value distribution [i](#)

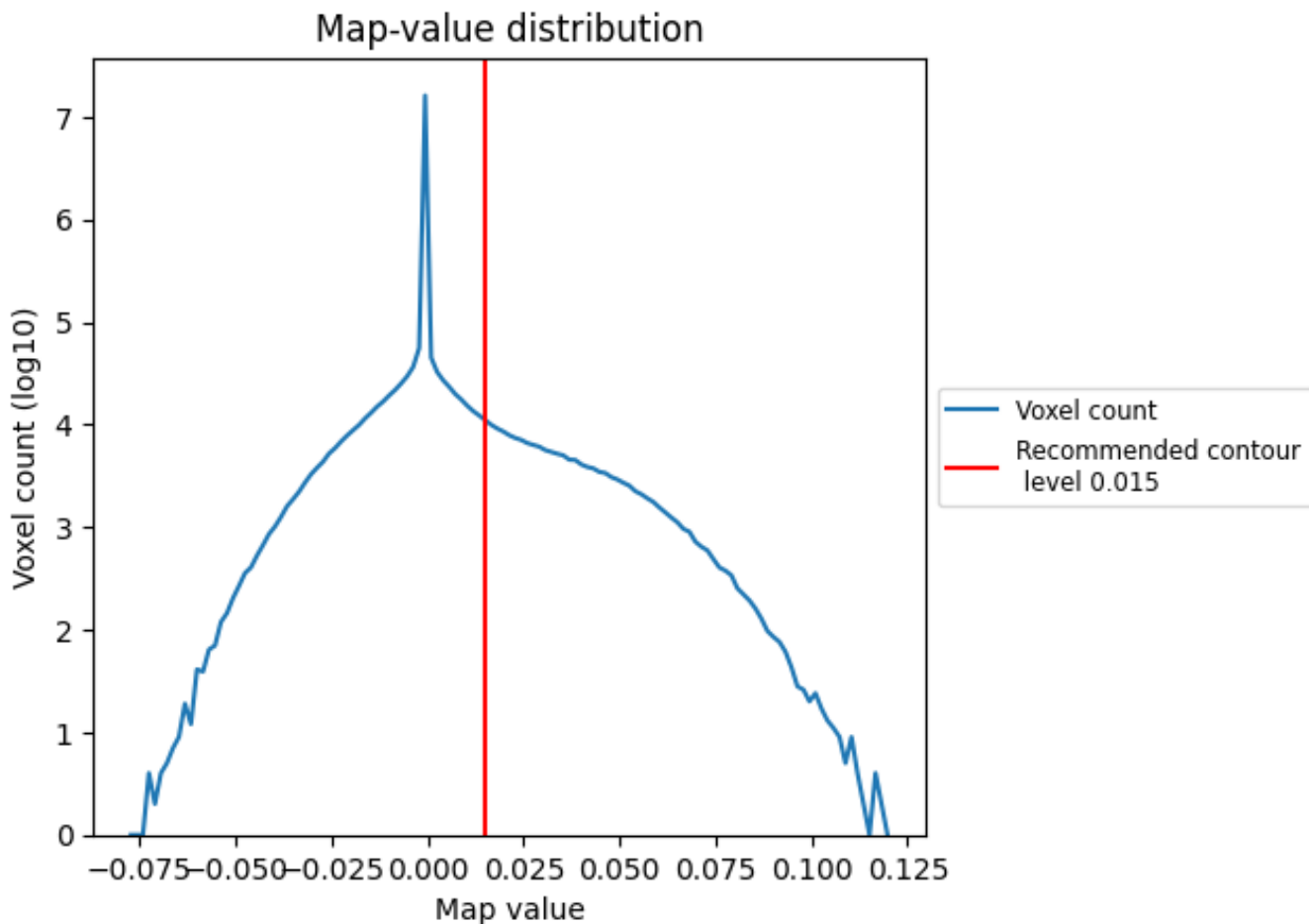

The map-value distribution is plotted in 128 intervals along the x-axis. The y-axis is logarithmic. A spike in this graph at zero usually indicates that the volume has been masked.

7.2 Volume estimate [i](#)

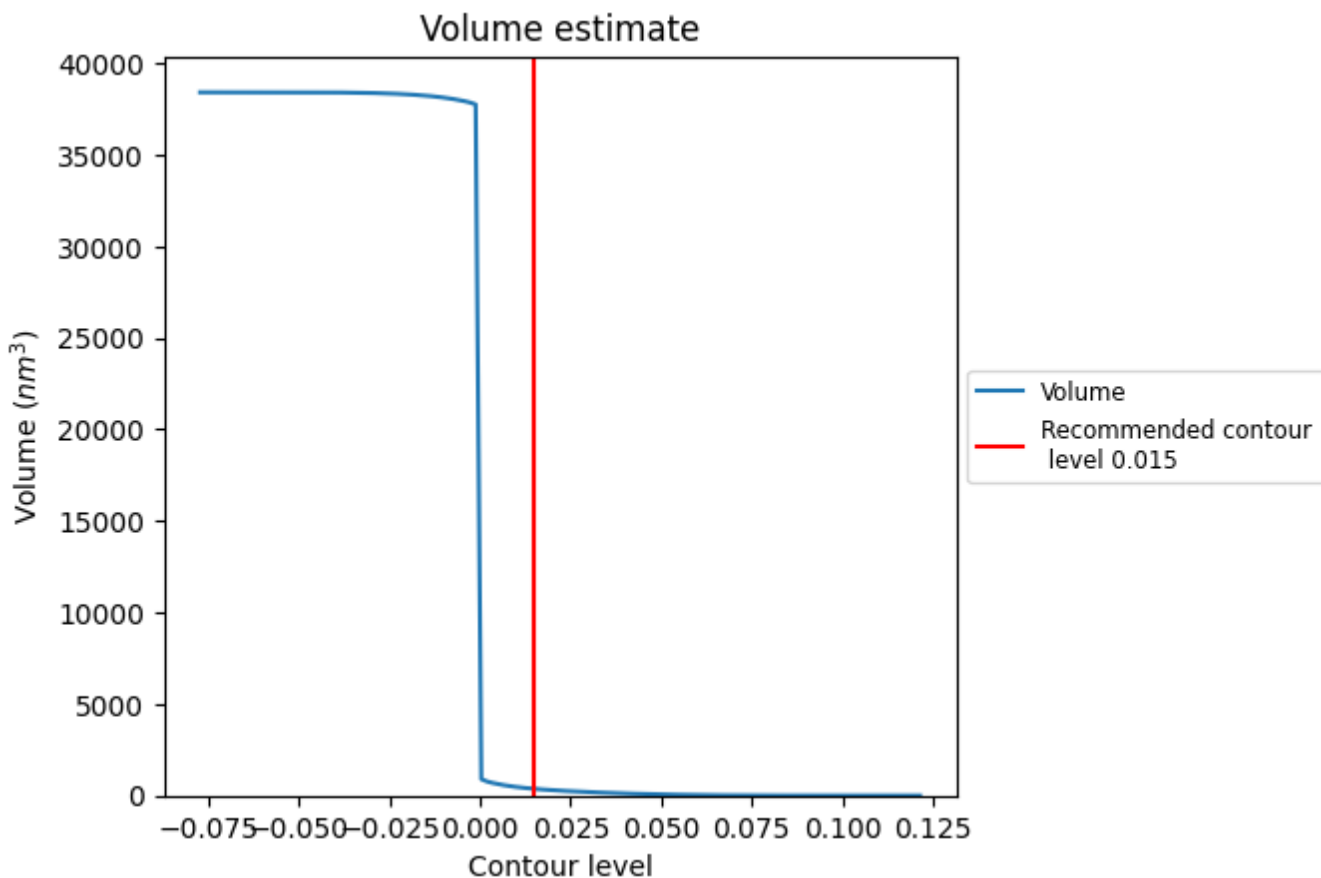

The volume at the recommended contour level is 368 nm³; this corresponds to an approximate mass of 333 kDa.

The volume estimate graph shows how the enclosed volume varies with the contour level. The recommended contour level is shown as a vertical line and the intersection between the line and the curve gives the volume of the enclosed surface at the given level.

7.3 Rotationally averaged power spectrum [i](#)

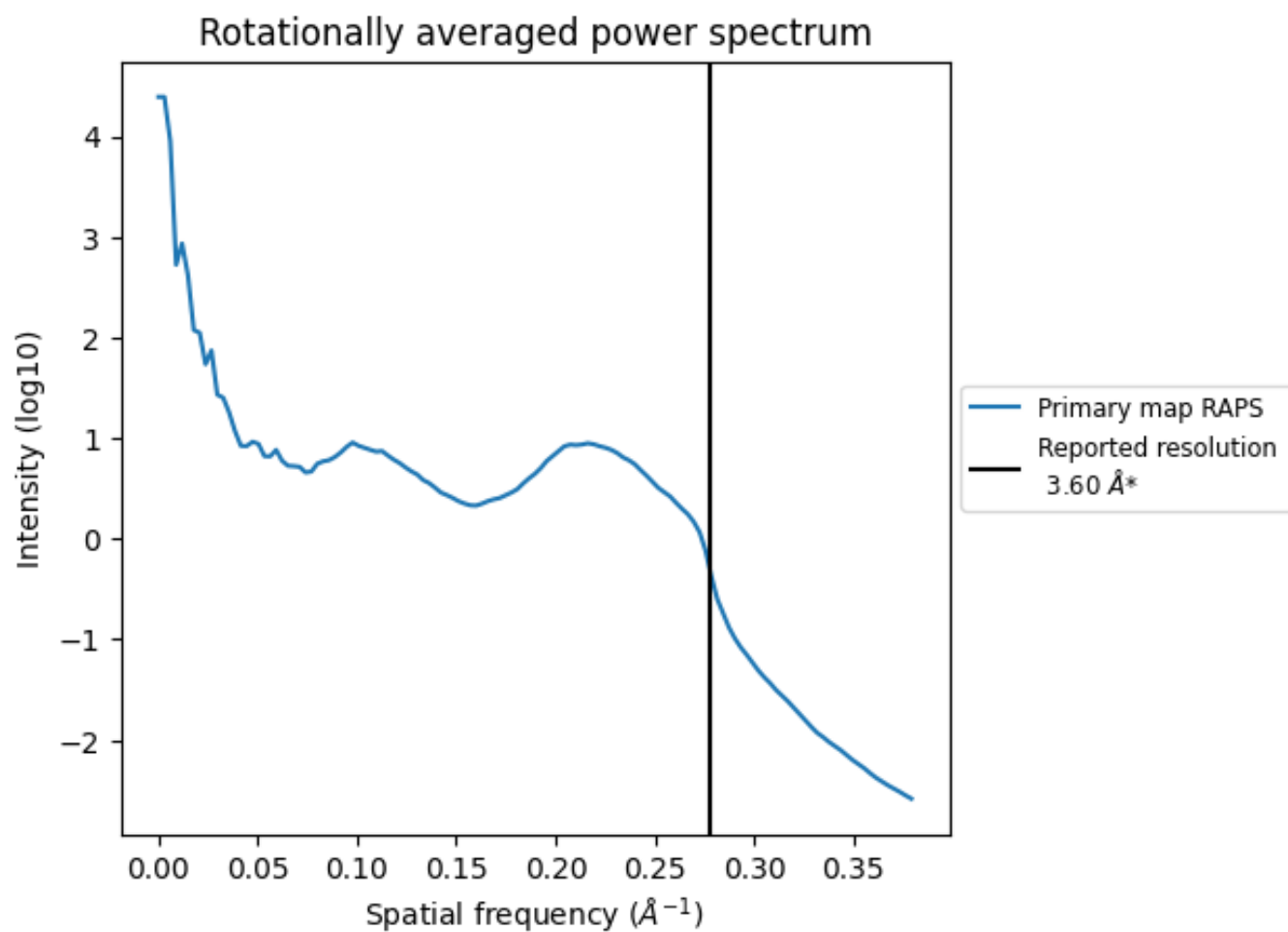

*Reported resolution corresponds to spatial frequency of 0.278 Å⁻¹

8 Fourier-Shell correlation

This section was not generated. No FSC curve or half-maps provided.

9 Map-model fit [i](#)

This section contains information regarding the fit between EMDB map EMD-45889 and PDB model 9CSA. Per-residue inclusion information can be found in section 3 on page 9.

9.1 Map-model overlay [i](#)

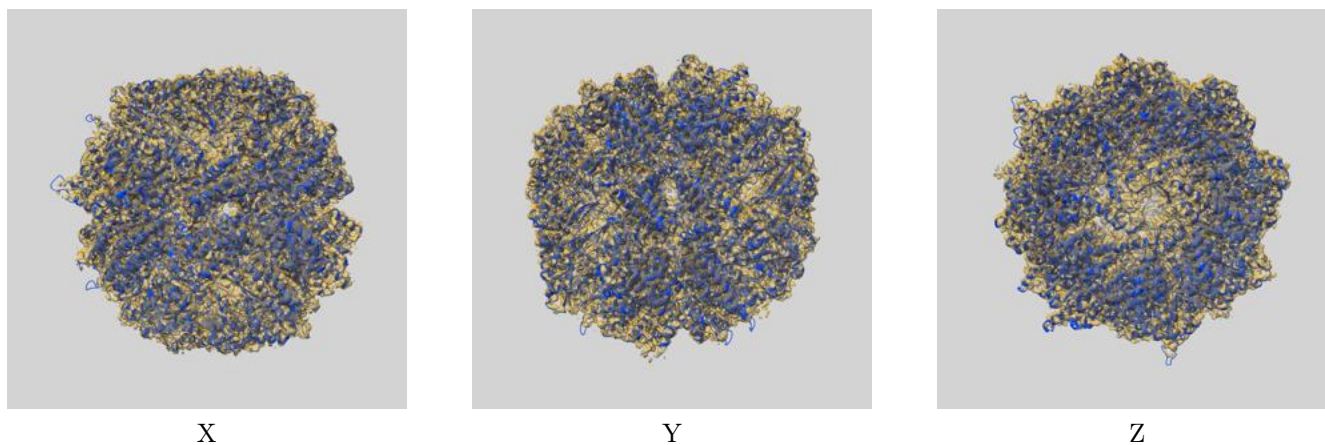

The images above show the 3D surface view of the map at the recommended contour level 0.015 at 50% transparency in yellow overlaid with a ribbon representation of the model coloured in blue. These images allow for the visual assessment of the quality of fit between the atomic model and the map.

9.2 Q-score mapped to coordinate model [i](#)

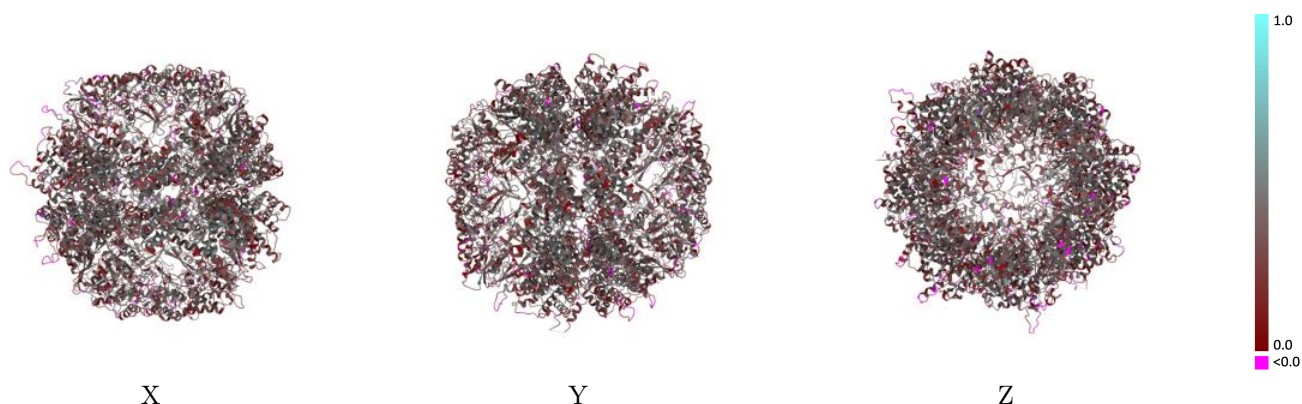

The images above show the model with each residue coloured according to its Q-score. This shows their resolvability in the map with higher Q-score values reflecting better resolvability. Please note: Q-score is calculating the resolvability of atoms, and thus high values are only expected at resolutions at which atoms can be resolved. Low Q-score values may therefore be expected for many entries.

9.3 Atom inclusion mapped to coordinate model [i](#)

This section was not generated.



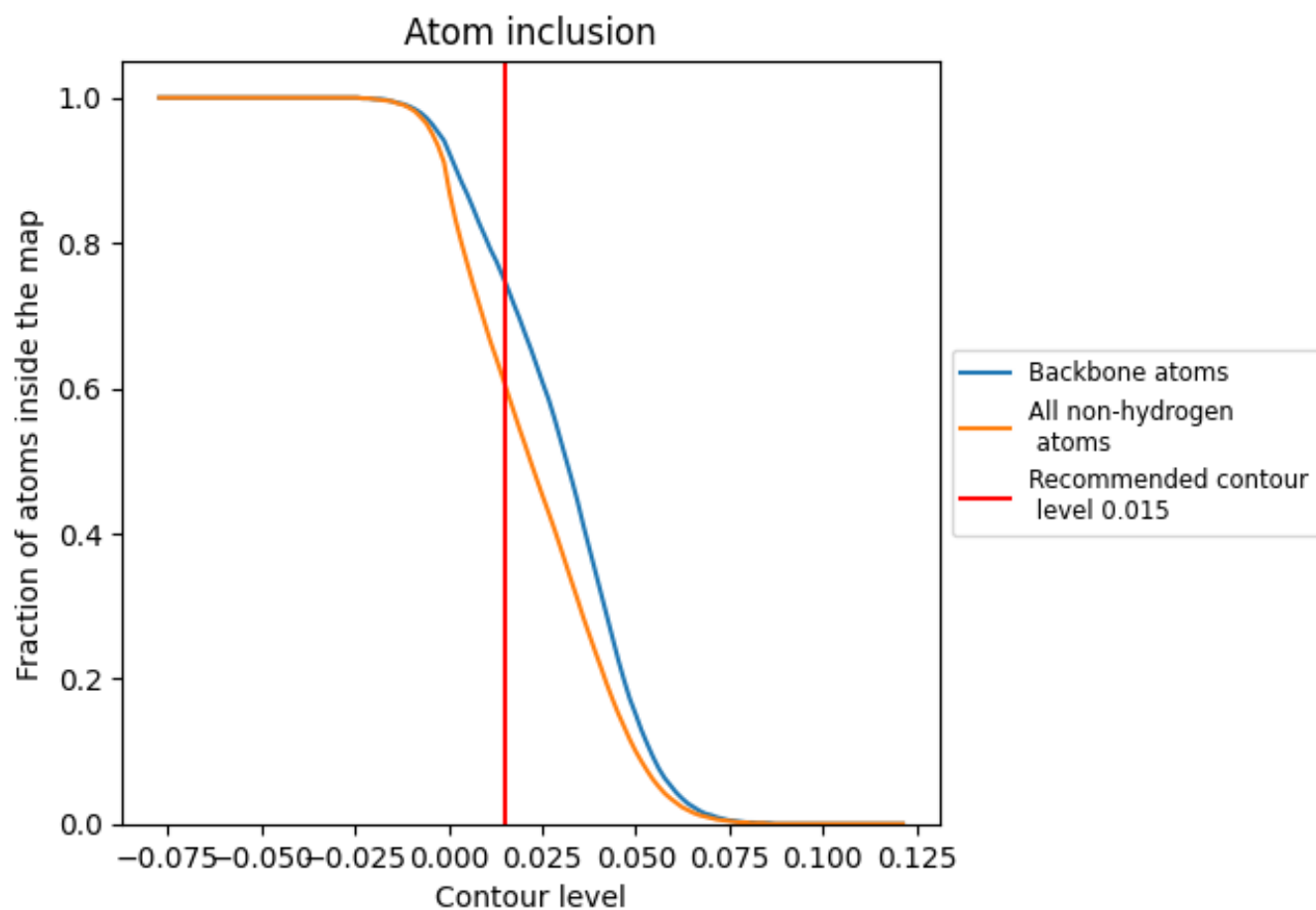































9.4 Atom inclusion [i](#)



At the recommended contour level, 75% of all backbone atoms, 61% of all non-hydrogen atoms, are inside the map.

9.5 Map-model fit summary

The table lists the average atom inclusion at the recommended contour level (0.015) and Q-score for the entire model and for each chain.

Chain	Atom inclusion	Q-score
All	 0.6060	 0.3330
A	 0.5860	 0.3200
B	 0.6460	 0.3550
D	 0.6280	 0.3480
E	 0.6220	 0.3430
G	 0.5990	 0.3300
H	 0.6140	 0.3340
Q	 0.5750	 0.3230
Z	 0.5780	 0.3110
a	 0.5940	 0.3240
b	 0.6400	 0.3520
d	 0.6200	 0.3400
e	 0.6210	 0.3420
g	 0.6080	 0.3390
h	 0.5980	 0.3280
q	 0.5850	 0.3220
z	 0.5910	 0.3260

