



wwPDB EM Validation Summary Report ⓘ

Apr 15, 2026 – 11:33 AM UTC

PDB ID : 6F9E / pdb_00006f9e
EMDB ID : EMD-4200
Title : Model of the Rift Valley fever virus glycoprotein hexamer type 3
Authors : Halldorsson, S.; Bowden, T.A.; Huiskonen, J.T.
Deposited on : 2017-12-14
Resolution : 13.30 Å(reported)

This is a wwPDB EM Validation Summary Report for a publicly released PDB entry.

We welcome your comments at validation@mail.wwpdb.org

A user guide is available at

<https://www.wwpdb.org/validation/2017/EMValidationReportHelp>

with specific help available everywhere you see the ⓘ symbol.

The types of validation reports are described at

<http://www.wwpdb.org/validation/2017/FAQs#types>.

The following versions of software and data (see [references ⓘ](#)) were used in the production of this report:

EMDB validation analysis : 0.0.1.dev132
MolProbity : 4-5-2 with Phenix2.0
Percentile statistics : 20250101.v01 (using entries in the PDB archive January 1st 2025)
EM percentile statistics : 202505.v01 (Using data in the EMDB archive up until May 2025)
MapQ : 1.9.13
Ideal geometry (proteins) : Engh & Huber (2001)
Ideal geometry (DNA, RNA) : Parkinson et al. (1996)
Validation Pipeline (wwPDB-VP) : 2.49

1 Overall quality at a glance

The following experimental techniques were used to determine the structure:
ELECTRON MICROSCOPY

The reported resolution of this entry is 13.30 Å.

Percentile scores (ranging between 0-100) for global validation metrics of the entry are shown in the following graphic. The table shows the number of entries on which the scores are based.

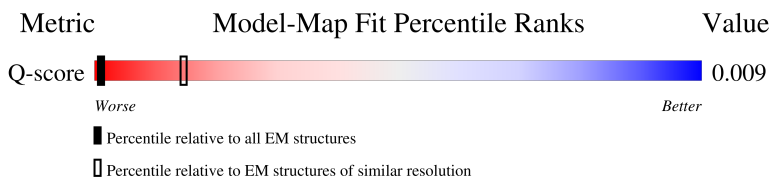
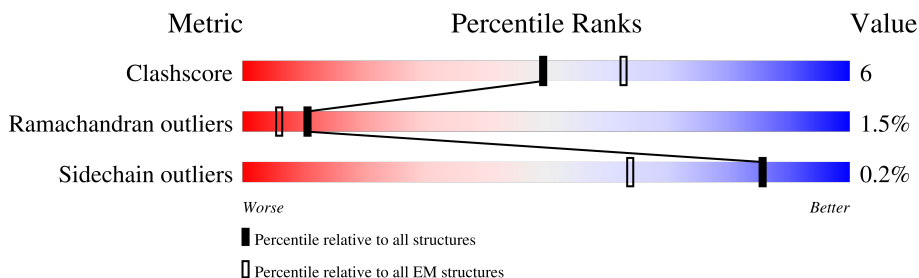

Metric	Whole archive (#Entries)	EM structures (#Entries)	Similar EM resolution (#Entries, resolution range(Å))
Clashscore	229148	23984	-
Ramachandran outliers	224038	23583	-
Sidechain outliers	223484	23102	-
Q-score	-	25397	62 (12.80 - 13.80)

The table below summarises the geometric issues observed across the polymeric chains and their fit to the map. The red, orange, yellow and green segments of the bar indicate the fraction of residues that contain outliers for ≥ 3 , 2, 1 and 0 types of geometric quality criteria respectively. A grey segment represents the fraction of residues that are not modelled. The numeric value for each fraction is indicated below the corresponding segment, with a dot representing fractions $\leq 5\%$. The upper red bar (where present) indicates the fraction of residues that have poor fit to the EM map (all-atom inclusion $< 40\%$). The numeric value is given above the bar.

Mol	Chain	Length	Quality of chain
1	A	316	<p>43% (poor fit), 81% (0 outliers), 14% (1 outlier), 5% (2 outliers)</p>
1	C	316	<p>46% (poor fit), 80% (0 outliers), 15% (1 outlier), 5% (2 outliers)</p>
1	E	316	<p>46% (poor fit), 80% (0 outliers), 16% (1 outlier), 5% (2 outliers)</p>
1	G	316	<p>43% (poor fit), 78% (0 outliers), 17% (1 outlier), 5% (2 outliers)</p>

Continued on next page...

Continued from previous page...

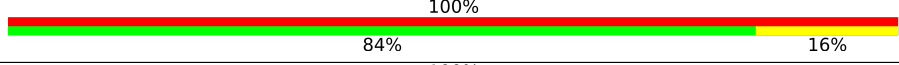
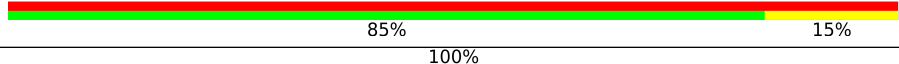
Mol	Chain	Length	Quality of chain
1	I	316	
1	K	316	
2	B	431	
2	D	431	
2	F	431	
2	H	431	
2	J	431	
2	L	431	

2 Entry composition i

There are 2 unique types of molecules in this entry. The entry contains 33048 atoms, of which 0 are hydrogens and 0 are deuteriums.

In the tables below, the AltConf column contains the number of residues with at least one atom in alternate conformation and the Trace column contains the number of residues modelled with at most 2 atoms.

- Molecule 1 is a protein called Glycoprotein.

Mol	Chain	Residues	Atoms					AltConf	Trace
			Total	C	N	O	S		
1	A	301	2284	1437	400	441	6	0	0
1	C	301	2284	1437	400	441	6	0	0
1	E	301	2284	1437	400	441	6	0	0
1	G	301	2284	1437	400	441	6	0	0
1	I	301	2284	1437	400	441	6	0	0
1	K	301	2284	1437	400	441	6	0	0

- Molecule 2 is a protein called Glycoprotein.

Mol	Chain	Residues	Atoms					AltConf	Trace
			Total	C	N	O	S		
2	B	431	3224	2006	561	652	5	0	0
2	D	431	3224	2006	561	652	5	0	0
2	F	431	3224	2006	561	652	5	0	0
2	H	431	3224	2006	561	652	5	0	0
2	J	431	3224	2006	561	652	5	0	0
2	L	431	3224	2006	561	652	5	0	0

There are 18 discrepancies between the modelled and reference sequences:

Chain	Residue	Modelled	Actual	Comment	Reference
B	688	ASP	-	expression tag	UNP A2T072
B	689	PRO	-	expression tag	UNP A2T072

Continued on next page...

Continued from previous page...

Chain	Residue	Modelled	Actual	Comment	Reference
B	690	GLY	-	expression tag	UNP A2T072
D	688	ASP	-	expression tag	UNP A2T072
D	689	PRO	-	expression tag	UNP A2T072
D	690	GLY	-	expression tag	UNP A2T072
F	688	ASP	-	expression tag	UNP A2T072
F	689	PRO	-	expression tag	UNP A2T072
F	690	GLY	-	expression tag	UNP A2T072
H	688	ASP	-	expression tag	UNP A2T072
H	689	PRO	-	expression tag	UNP A2T072
H	690	GLY	-	expression tag	UNP A2T072
J	688	ASP	-	expression tag	UNP A2T072
J	689	PRO	-	expression tag	UNP A2T072
J	690	GLY	-	expression tag	UNP A2T072
L	688	ASP	-	expression tag	UNP A2T072
L	689	PRO	-	expression tag	UNP A2T072
L	690	GLY	-	expression tag	UNP A2T072

3 Residue-property plots [i](#)

These plots are drawn for all protein, RNA, DNA and oligosaccharide chains in the entry. The first graphic for a chain summarises the proportions of the various outlier classes displayed in the second graphic. The second graphic shows the sequence view annotated by issues in geometry and atom inclusion in map density. Residues are color-coded according to the number of geometric quality criteria for which they contain at least one outlier: green = 0, yellow = 1, orange = 2 and red = 3 or more. A red diamond above a residue indicates a poor fit to the EM map for this residue (all-atom inclusion < 40%). Stretches of 2 or more consecutive residues without any outlier are shown as a green connector. Residues present in the sample, but not in the model, are shown in grey.

- Molecule 1: Glycoprotein

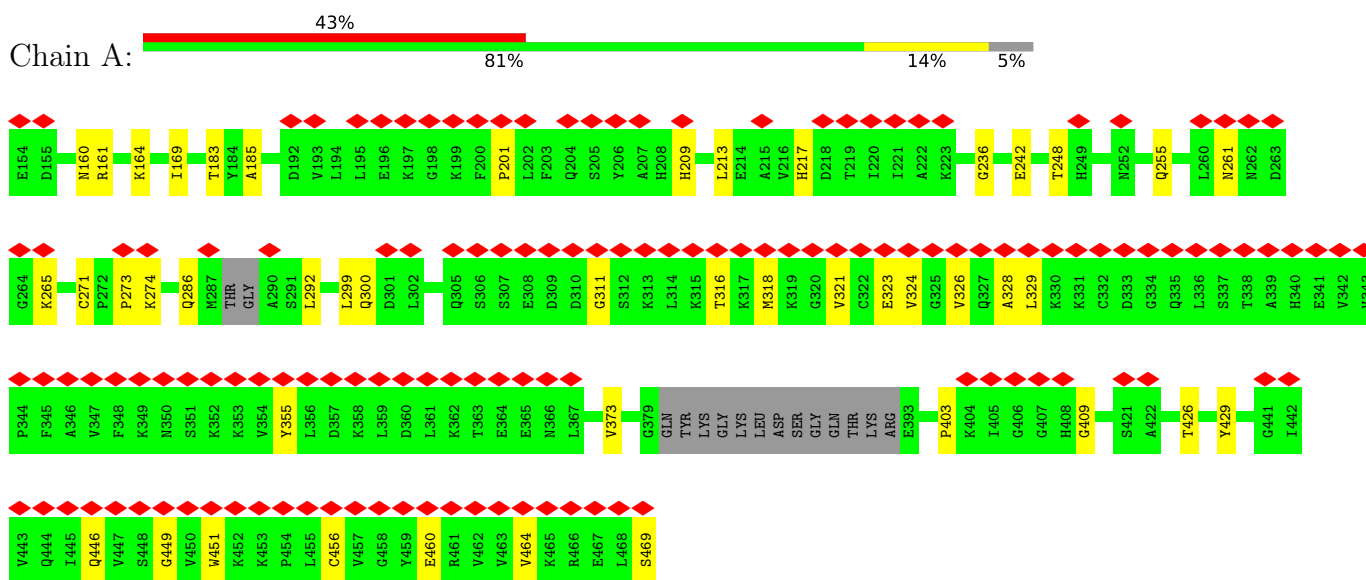

- Molecule 1: Glycoprotein

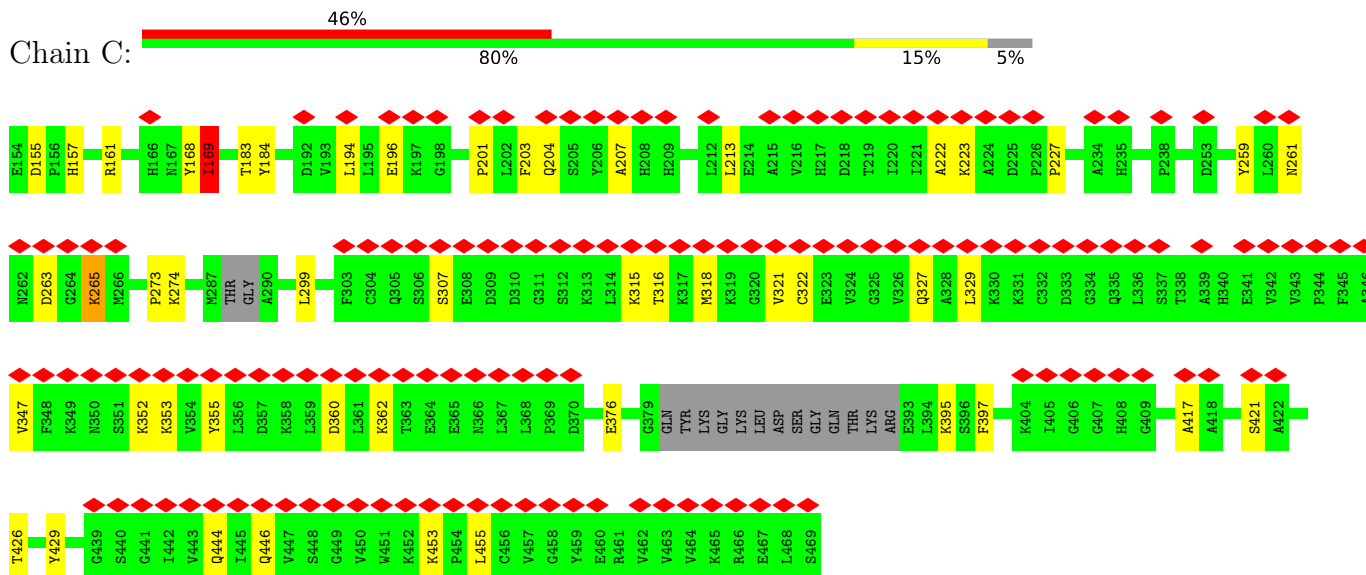

- Molecule 1: Glycoprotein

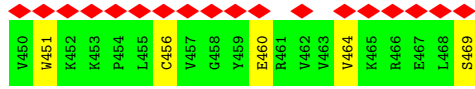

• Molecule 1: Glycoprotein

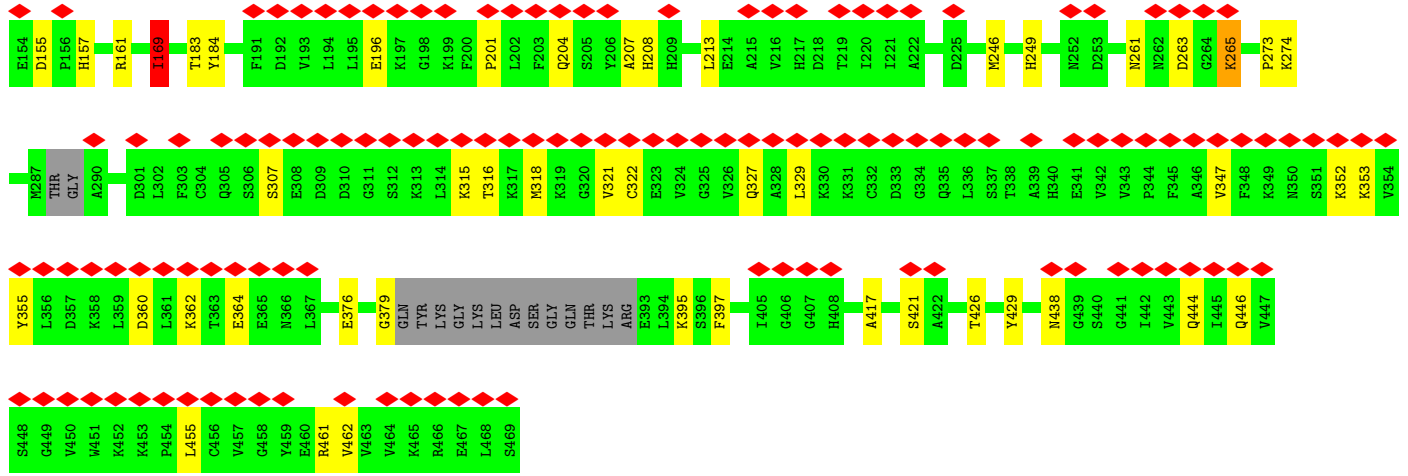
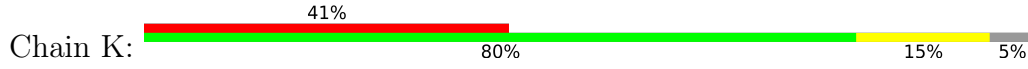

• Molecule 2: Glycoprotein

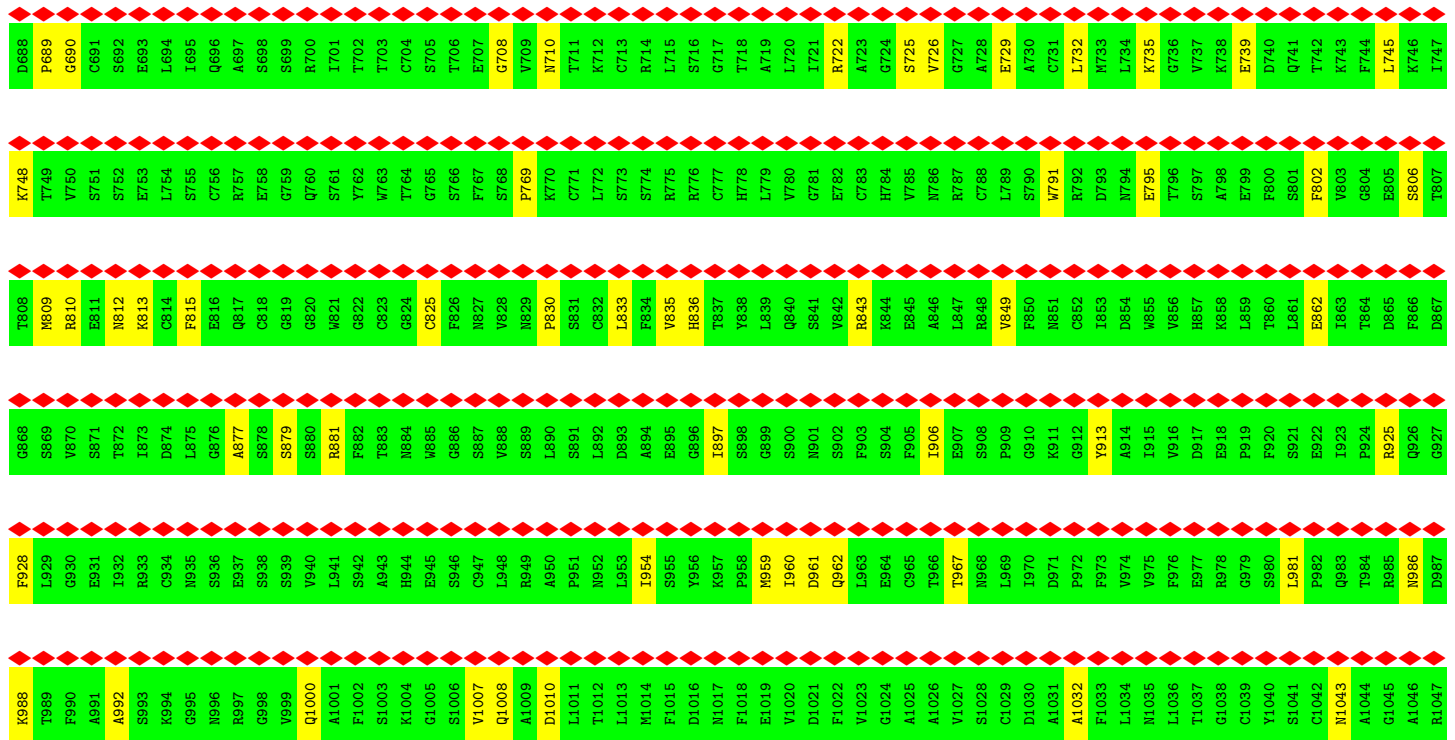
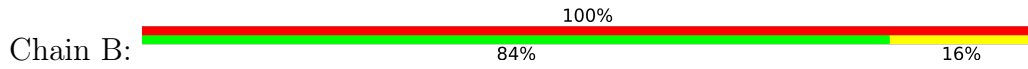



• Molecule 2: Glycoprotein

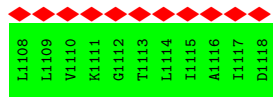
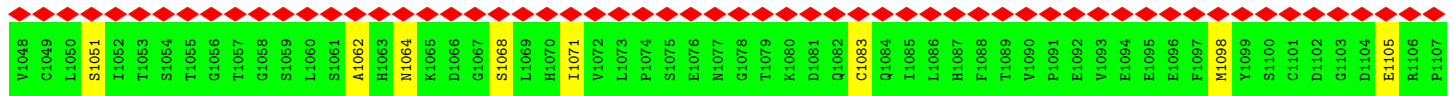
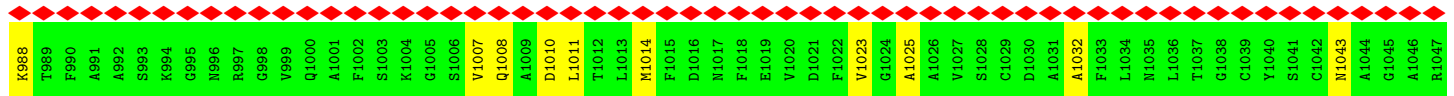
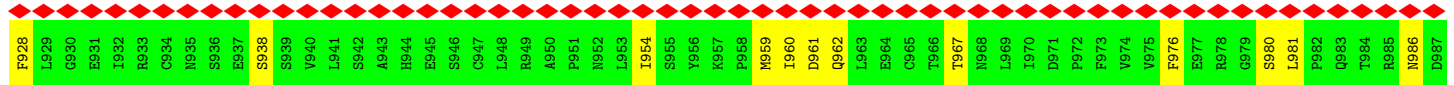
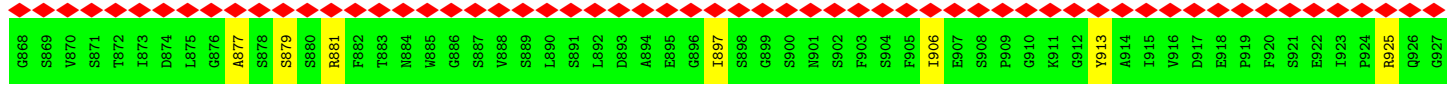
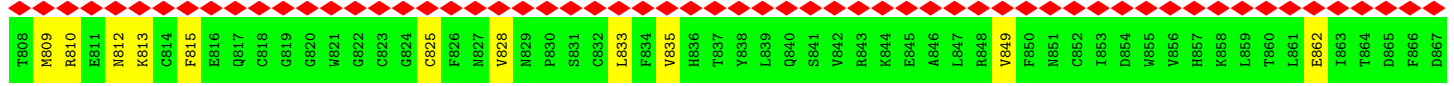
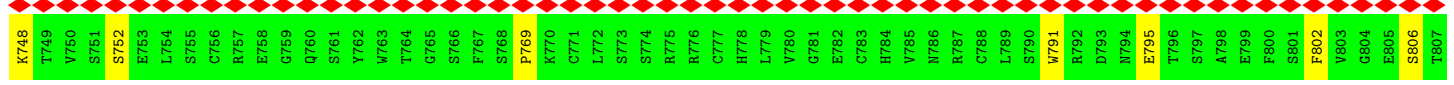
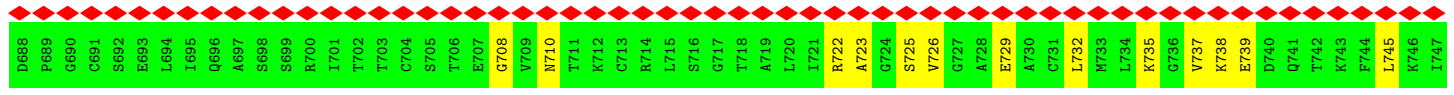
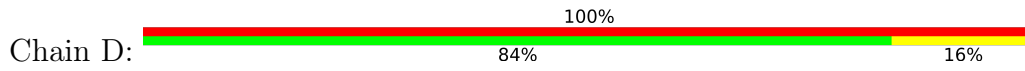

• Molecule 2: Glycoprotein

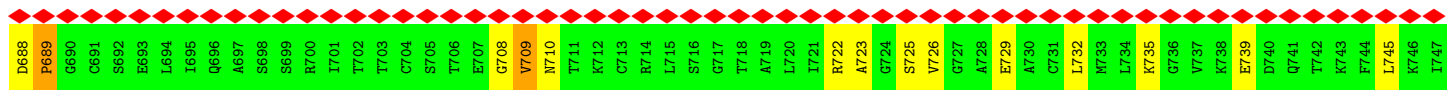
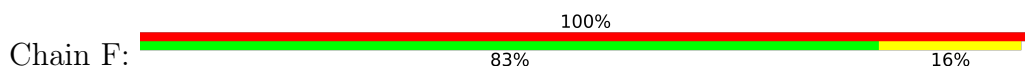

K748	T808	G868	F928	K988	V1048	L1108
T749	M809	S869	L929	T989	C1049	L1109
V750	R810	S870	G930	F990	L1050	V1110
S751	E811	S871	E931	A991	S1051	K1111
S752	N812	T872	I932	A992	I1052	G1112
E753	K813	I873	R933	S993	T1053	T1113
L754	C814	D874	C934	K994	S1054	L1114
S755	F815	L875	N935	G995	T1055	I1115
C756	E816	G876	S936	N996	G1056	A1116
R757	Q817	A877	E937	R997	T1057	I1117
E758	C818	S878	S938	G998	G1058	D1118
G759	G819	S879	S939	V999	S1059	
Q760	S880	S880	V940	Q1000	L1060	
S761	W821	R881	L941	A1001	S1061	
Y762	W822	F882	S942	F1002	A1062	
W763	C823	T883	A943	S1003	H1063	
T764	G824	N884	H944	K1004	M1064	
G765	C825	W885	E945	G1005	K1065	
S766	F826	G886	S946	S1006	K1066	
F767	N827	S887	C947	V1007	G1067	
S768	V828	S888	L948	Q1008	S1068	
P769	N829	S889	R949	A1009	L1069	
K770	P830	L890	A950	D1010	H1070	
C771	S831	S891	P951	L1011	I1071	
L772	C832	L892	N952	T1012	V1072	
S773	L833	D893	L953	L1013	L1073	
S774	F834	A894	I954	M1014	P1074	
R775	V835	E895	S955	F1015	S1075	
R776	H836	G896	Y956	D1016	E1076	
C777	T837	S897	K957	N1017	M1077	
H778	Y838	S898	P958	F1018	G1078	
L779	L839	G899	M959	E1019	T1079	
Q780	Q840	S900	I960	V1020	K1080	
W781	S841	N901	D961	D1021	D1081	
E782	V842	S902	Q962	F1022	Q1082	
C783	R843	F903	L963	V1023	C1083	
H784	K844	S904	E964	G1024	Q1084	
V785	E845	F905	C965	A1025	I1085	
N786	A846	I906	T966	A1026	L1086	
R787	L847	E907	T967	V1027	H1087	
C788	R848	S908	N968	S1028	F1088	
L789	V849	P909	L969	C1029	T1089	
S790	F850	G910	I970	D1030	V1090	
W791	N851	K911	D971	A1031	P1091	
R792	C852	G912	F972	A1032	E1092	
D793	S853	Y913	F973	F1033	V1093	
W794	D854	A914	V974	L1034	E1094	
E795	W855	I915	V975	N1035	E1095	
T796	V856	V916	F976	L1036	E1096	
S797	H857	D917	E977	T1037	F1097	
A798	K858	E918	R978	G1038	M1098	
F799	L859	P919	G979	C1039	Y1099	
F800	T860	F920	S980	Y1040	S1100	
S801	L861	S921	L981	C1042	C1101	
F802	E862	E922	P982	M1043	D1102	
V803	I863	I923	Q983	A1044	G1103	
G804	T864	L924	T984	G1045	D1104	
E805	D865	R925	S985	A1046	E1105	
S806	F866	Q926	N986	A1046	R1106	
T807	D867	G927	D987	R1107	P1107	

• Molecule 2: Glycoprotein

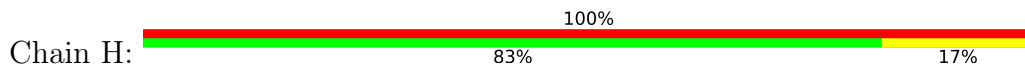

D688	K748	G868	F928	K988	V1048	L1108
P689	T749	S869	L929	T989	C1049	L1109
G690	V750	S870	G930	F990	L1050	V1110
C691	S751	S871	E931	A991	S1051	K1111
S692	N812	T872	I932	A992	I1052	G1112
F693	K813	I873	R933	S993	T1053	T1113
L694	C814	D874	C934	K994	S1054	L1114
I695	F815	L875	N935	G995	T1055	I1115
G696	C756	G876	S936	N996	G1056	A1116
A697	R757	A877	E937	R997	T1057	I1117
S698	E758	S878	S938	G998	G1058	D1118
S699	G759	S879	S939	V999	S1059	
R700	Q760	S880	V940	Q1000	L1060	
I701	S761	R881	L941	A1001	S1061	
T702	Y762	F882	S942	F1002	A1062	
T703	W763	T883	A943	S1003	H1063	
C704	T764	N884	H944	K1004	M1064	
S705	G765	W885	E945	G1005	K1065	
T706	S766	G886	S946	S1006	K1066	
E707	F767	S887	C947	V1007	G1067	
G708	S768	S888	L948	Q1008	S1068	
V709	P769	S889	R949	A1009	L1069	
W710	K770	L890	A950	D1010	H1070	
T711	C771	S891	P951	L1011	I1071	
K712	L772	L892	N952	T1012	V1072	
C713	S773	D893	L953	L1013	L1073	
R714	F774	A894	I954	M1014	P1074	
L715	R775	E895	S955	F1015	S1075	
S716	R776	G896	Y956	D1016	E1076	
G717	C777	T897	K957	N1017	M1077	
T718	H778	S898	P958	F1018	G1078	
A719	L779	G899	M959	E1019	T1079	
L720	W780	S900	I960	V1020	K1080	
I721	G781	N901	D961	D1021	D1081	
R722	E782	S902	Q962	F1022	Q1082	
A723	C783	F903	L963	V1023	C1083	
G724	H784	S904	E964	G1024	Q1084	
S725	V785	F905	C965	A1025	I1085	
V726	N786	I906	T966	A1026	L1086	
G727	R787	E907	T967	V1027	H1087	
A728	C788	S908	N968	S1028	F1088	
E729	L789	P909	L969	C1029	T1089	
A730	S790	G910	I970	D1030	V1090	
C731	W791	K911	D971	A1031	P1091	
L732	R792	C852	F972	A1032	E1092	
M733	D793	S853	F973	F1033	V1093	
L734	W794	D854	V974	L1034	E1094	
K735	E795	W855	V975	N1035	E1095	
G736	T796	V856	F976	L1036	E1096	
V737	S797	D917	E977	T1037	F1097	
K738	A798	K858	R978	G1038	M1098	
E739	F799	L859	G979	C1039	Y1099	
O740	F800	T860	S980	Y1040	S1100	
T742	S801	L861	S921	C1042	C1101	
K743	F802	E862	P982	M1043	D1102	
F744	V803	I863	I923	A1044	G1103	
L745	G804	T864	L924	G1045	D1104	
K746	E805	D865	R925	A1046	E1105	
I747	S806	F866	Q926	A1046	R1106	
	T807	D867	G927	R1107	P1107	

K988	T989	F990	A991	A992	S993	K994	G995	R996	R997	G998	V999	Q1000	A1001	F1002	S1003	K1004	G1005	S1006	V1007	Q1008	A1009	D1010	L1011	T1012	L1013	M1014	F1015	D1016	N1017	F1018	E1019	D1020	F1022	V1023	G1024	A1025	A1026	V1027	S1028	C1029	D1030	A1031	A1032	F1033	L1034	N1035	L1036	T1037	G1038	C1039	Y1040	S1041	C1042	N1043	A1044	G1045	A1046	R1047	
V1048	C1049	L1050	S1051	T1052	T1053	S1054	T1055	G1056	T1057	G1058	S1059	L1060	S1061	A1062	H1063	N1064	K1065	D1066	G1067	S1068	L1069	H1070	I1071	V1072	L1073	P1074	S1075	E1076	N1077	G1078	T1079	K1080	D1081	Q1082	C1083	Q1084	L1085	L1086	H1087	F1088	T1089	V1090	P1091	E1092	V1093	E1094	E1095	E1096	F1097	M1098	Y1099	S1100	C1101	D1102	G1103	D1104	E1105	R1106	P1107
L1108	L1109	V1110	K1111	G1112	T1113	L1114	I1115	A1116	I1117	D1118																																																	

• Molecule 2: Glycoprotein

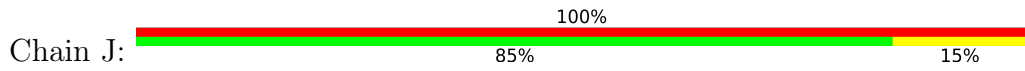

D688	P689	G690	C691	S692	E693	L694	T695	Q696	A697	S698	S699	R700	I701	T702	T703	C704	S705	T706	E707	G708	V709	N710	T711	K712	C713	R714	L715	S716	G717	T718	A719	L720	I721	R722	A723	G724	V726	G727	A728	E729	A730	C731	L732	F733	L734	K735	G736	K738	E739	D740	T742	K743	F744	L745	K746	I747			
K748	T749	V750	S751	S752	E753	L754	S755	C756	R757	E758	G759	Q760	S761	V762	W763	T764	G765	S766	F767	S768	V769	K770	C771	L772	S773	S774	R775	R776	C777	H778	L779	V780	G781	E782	C783	H784	V785	M786	R787	C788	L789	S790	W791	R792	D793	M794	E795	T796	S797	A798	E799	F800	S801	F802	W803	G804	S806	T807	
T809	N809	R810	E811	N812	K813	C814	F815	E816	Q817	C818	G819	G820	W821	G822	C823	G824	C825	F826	N827	W828	N829	P830	S831	C832	L833	F834	Y835	H836	T837	Y838	L839	Q840	S841	W842	R843	K844	E845	A846	R848	Y849	F850	N851	C852	L853	D854	W855	W856	H857	K858	L859	T860	L861	E862	T863	G864	D865	F866	D867	
G868	S869	V870	S871	T872	R873	D874	L875	G876	A877	S878	S879	S880	R881	F882	T883	N884	W885	G886	S887	W888	S889	L890	S891	L892	D893	A894	E895	G896	L897	P898	M899	I900	D901	Q902	F903	S904	F905	I906	E907	S908	P909	G910	K911	G912	Y913	A914	I915	V916	D917	E918	P919	F920	S921	E922	P923	P924	Q925	Q926	G927
F928	L929	G930	E931	I932	R933	C934	N935	S936	E937	S938	S939	V940	L941	S942	A943	H944	E945	S946	C947	L948	R949	A950	P951	N952	L953	I954	S955	Y956	K957	P958	M959	I960	D961	Q962	L963	E964	C965	T966	T967	N968	L969	I970	D971	F972	F973	V974	V975	F976	E977	A978	G979	S980	L981	P982	Q983	T984	R985	N986	D987
K988	T989	F990	A991	A992	S993	K994	G995	N996	R997	G998	V999	Q1000	A1001	F1002	S1003	K1004	G1005	S1006	V1007	Q1008	A1009	D1010	L1011	T1012	L1013	M1014	F1015	D1016	N1017	F1018	E1019	D1020	F1022	V1023	G1024	A1025	A1026	V1027	S1028	C1029	D1030	A1031	A1032	F1033	L1034	N1035	L1036	T1037	G1038	C1039	Y1040	S1041	C1042	N1043	A1044	G1045	A1046	R1047	
V1048	C1049	L1050	S1051	T1052	T1053	S1054	T1055	G1056	T1057	G1058	S1059	L1060	S1061	A1062	H1063	N1064	K1065	D1066	G1067	S1068	L1069	H1070	I1071	V1072	L1073	P1074	S1075	E1076	N1077	G1078	T1079	K1080	D1081	Q1082	C1083	Q1084	L1085	L1086	H1087	F1088	T1089	V1090	P1091	E1092	V1093	E1094	E1095	E1096	F1097	M1098	Y1099	S1100	C1101	D1102	G1103	D1104	E1105	R1106	P1107
L1108	L1109	V1110	K1111	G1112	T1113	L1114	I1115	A1116	I1117	D1118																																																	

• Molecule 2: Glycoprotein

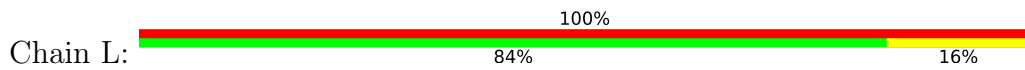

4 Experimental information

Property	Value	Source
EM reconstruction method	SINGLE PARTICLE	Depositor
Imposed symmetry	POINT, Not provided	
Number of particles used	2995	Depositor
Resolution determination method	FSC 0.143 CUT-OFF	Depositor
CTF correction method	PHASE FLIPPING AND AMPLITUDE CORRECTION	Depositor
Microscope	FEI TECNAI F30	Depositor
Voltage (kV)	300	Depositor
Electron dose ($e^-/\text{\AA}^2$)	22	Depositor
Minimum defocus (nm)	Not provided	
Maximum defocus (nm)	Not provided	
Magnification	Not provided	
Image detector	GATAN K2 SUMMIT (4k x 4k)	Depositor
Maximum map value	0.121	Depositor
Minimum map value	-0.060	Depositor
Average map value	-0.003	Depositor
Map value standard deviation	0.019	Depositor
Recommended contour level	0.03	Depositor
Map size (Å)	345.6, 345.6, 345.6	wwPDB
Map dimensions	128, 128, 128	wwPDB
Map angles (°)	90.0, 90.0, 90.0	wwPDB
Pixel spacing (Å)	2.7, 2.7, 2.7	Depositor

5 Model quality [i](#)

5.1 Standard geometry [i](#)

The Z score for a bond length (or angle) is the number of standard deviations the observed value is removed from the expected value. A bond length (or angle) with $|Z| > 5$ is considered an outlier worth inspection. RMSZ is the root-mean-square of all Z scores of the bond lengths (or angles).

Mol	Chain	Bond lengths		Bond angles	
		RMSZ	# Z >5	RMSZ	# Z >5
1	A	0.07	0/2333	0.22	0/3136
1	C	0.10	0/2333	0.28	0/3136
1	E	0.07	0/2333	0.21	0/3136
1	G	0.09	0/2333	0.27	0/3136
1	I	0.07	0/2333	0.21	0/3136
1	K	0.09	0/2333	0.27	0/3136
2	B	0.08	0/3284	0.24	0/4431
2	D	0.09	0/3284	0.24	0/4431
2	F	0.09	0/3284	0.28	2/4431 (0.0%)
2	H	0.08	0/3284	0.24	0/4431
2	J	0.09	0/3284	0.24	0/4431
2	L	0.09	0/3284	0.24	0/4431
All	All	0.08	0/33702	0.25	2/45402 (0.0%)

There are no bond length outliers.

All (2) bond angle outliers are listed below:

Mol	Chain	Res	Type	Atoms	Z	Observed(°)	Ideal(°)
2	F	689	PRO	CA-C-N	5.97	134.78	120.99
2	F	689	PRO	C-N-CA	5.97	134.78	120.99

There are no chirality outliers.

There are no planarity outliers.

5.2 Too-close contacts [i](#)

In the following table, the Non-H and H(model) columns list the number of non-hydrogen atoms and hydrogen atoms in the chain respectively. The H(added) column lists the number of hydrogen atoms added and optimized by MolProbity. The Clashes column lists the number of clashes within the asymmetric unit, whereas Symm-Clashes lists symmetry-related clashes.

Mol	Chain	Non-H	H(model)	H(added)	Clashes	Symm-Clashes
1	A	2284	0	2205	22	0
1	C	2284	0	2205	28	0
1	E	2284	0	2205	28	0
1	G	2284	0	2205	33	0
1	I	2284	0	2205	22	0
1	K	2284	0	2205	28	0
2	B	3224	0	3071	37	0
2	D	3224	0	3071	38	0
2	F	3224	0	3071	39	0
2	H	3224	0	3071	43	0
2	J	3224	0	3071	36	0
2	L	3224	0	3071	40	0
All	All	33048	0	31656	370	0

The all-atom clashscore is defined as the number of clashes found per 1000 atoms (including hydrogen atoms). The all-atom clashscore for this structure is 6.

The worst 5 of 370 close contacts within the same asymmetric unit are listed below, sorted by their clash magnitude.

Atom-1	Atom-2	Interatomic distance (Å)	Clash overlap (Å)
2:H:926:GLN:NE2	2:H:931:GLU:OE2	2.27	0.67
2:D:959:MET:HB2	2:D:962:GLN:HB2	1.79	0.65
2:F:959:MET:HB2	2:F:962:GLN:HB2	1.79	0.64
2:D:1062:ALA:HB3	2:D:1071:ILE:HB	1.80	0.64
2:B:959:MET:HB2	2:B:962:GLN:HB2	1.79	0.64

There are no symmetry-related clashes.

5.3 Torsion angles [i](#)

5.3.1 Protein backbone [i](#)

In the following table, the Percentiles column shows the percent Ramachandran outliers of the chain as a percentile score with respect to all PDB entries followed by that with respect to all EM entries.

The Analysed column shows the number of residues for which the backbone conformation was analysed, and the total number of residues.

Mol	Chain	Analysed	Favoured	Allowed	Outliers	Percentiles
1	A	295/316 (93%)	251 (85%)	39 (13%)	5 (2%)	7 36

Continued on next page...

Continued from previous page...

Mol	Chain	Analysed	Favoured	Allowed	Outliers	Percentiles	
1	C	295/316 (93%)	253 (86%)	38 (13%)	4 (1%)	9	40
1	E	295/316 (93%)	254 (86%)	37 (12%)	4 (1%)	9	40
1	G	295/316 (93%)	250 (85%)	39 (13%)	6 (2%)	6	31
1	I	295/316 (93%)	254 (86%)	37 (12%)	4 (1%)	9	40
1	K	295/316 (93%)	252 (85%)	39 (13%)	4 (1%)	9	40
2	B	429/431 (100%)	372 (87%)	51 (12%)	6 (1%)	9	40
2	D	429/431 (100%)	370 (86%)	53 (12%)	6 (1%)	9	40
2	F	429/431 (100%)	372 (87%)	50 (12%)	7 (2%)	7	38
2	H	429/431 (100%)	374 (87%)	49 (11%)	6 (1%)	9	40
2	J	429/431 (100%)	372 (87%)	50 (12%)	7 (2%)	7	38
2	L	429/431 (100%)	372 (87%)	50 (12%)	7 (2%)	7	38
All	All	4344/4482 (97%)	3746 (86%)	532 (12%)	66 (2%)	11	40

5 of 66 Ramachandran outliers are listed below:

Mol	Chain	Res	Type
1	A	456	CYS
2	B	825	CYS
2	D	825	CYS
1	E	456	CYS
2	F	709	VAL

5.3.2 Protein sidechains [i](#)

In the following table, the Percentiles column shows the percent sidechain outliers of the chain as a percentile score with respect to all PDB entries followed by that with respect to all EM entries.

The Analysed column shows the number of residues for which the sidechain conformation was analysed, and the total number of residues.

Mol	Chain	Analysed	Rotameric	Outliers	Percentiles	
1	A	241/271 (89%)	240 (100%)	1 (0%)	84	84
1	C	241/271 (89%)	240 (100%)	1 (0%)	84	84
1	E	241/271 (89%)	240 (100%)	1 (0%)	84	84
1	G	241/271 (89%)	240 (100%)	1 (0%)	84	84
1	I	241/271 (89%)	240 (100%)	1 (0%)	84	84

Continued on next page...

Continued from previous page...

Mol	Chain	Analysed	Rotameric	Outliers	Percentiles	
1	K	241/271 (89%)	240 (100%)	1 (0%)	84	84
2	B	347/371 (94%)	347 (100%)	0	100	100
2	D	347/371 (94%)	347 (100%)	0	100	100
2	F	347/371 (94%)	346 (100%)	1 (0%)	86	86
2	H	347/371 (94%)	347 (100%)	0	100	100
2	J	347/371 (94%)	347 (100%)	0	100	100
2	L	347/371 (94%)	346 (100%)	1 (0%)	86	86
All	All	3528/3852 (92%)	3520 (100%)	8 (0%)	85	87

5 of 8 residues with a non-rotameric sidechain are listed below:

Mol	Chain	Res	Type
2	L	709	VAL
1	K	169	ILE
1	G	169	ILE
2	F	709	VAL
1	I	469	SER

Sometimes sidechains can be flipped to improve hydrogen bonding and reduce clashes. 5 of 54 such sidechains are listed below:

Mol	Chain	Res	Type
1	G	300	GLN
1	I	167	ASN
2	L	760	GLN
1	G	438	ASN
2	H	962	GLN

5.3.3 RNA ⓘ

There are no RNA molecules in this entry.

5.4 Non-standard residues in protein, DNA, RNA chains ⓘ

There are no non-standard protein/DNA/RNA residues in this entry.

5.5 Carbohydrates [i](#)

There are no oligosaccharides in this entry.

5.6 Ligand geometry [i](#)

There are no ligands in this entry.

5.7 Other polymers [i](#)

There are no such residues in this entry.

5.8 Polymer linkage issues [i](#)

There are no chain breaks in this entry.

6 Map visualisation [i](#)

This section contains visualisations of the EMDB entry EMD-4200. These allow visual inspection of the internal detail of the map and identification of artifacts.

No raw map or half-maps were deposited for this entry and therefore no images, graphs, etc. pertaining to the raw map can be shown.

6.1 Orthogonal projections [i](#)

6.1.1 Primary map

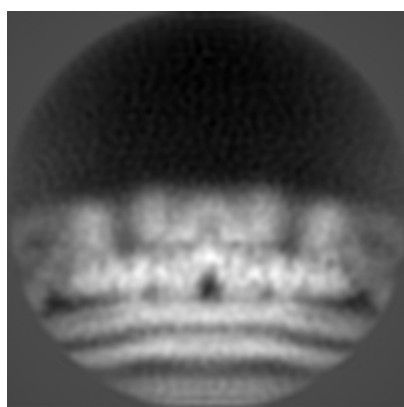

X

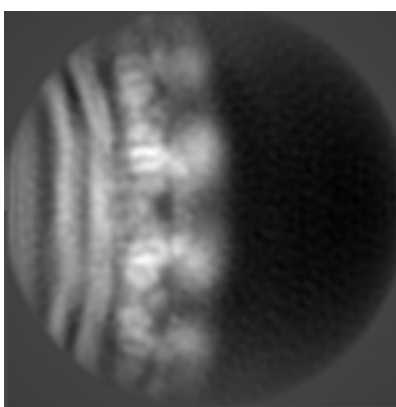

Y

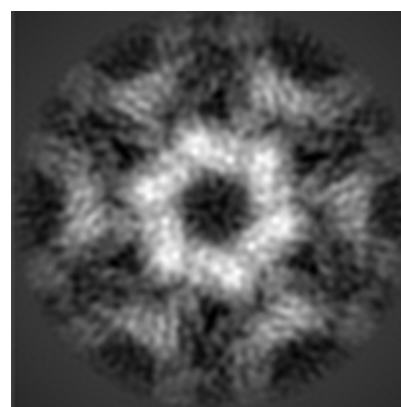

Z

The images above show the map projected in three orthogonal directions.

6.2 Central slices [i](#)

6.2.1 Primary map

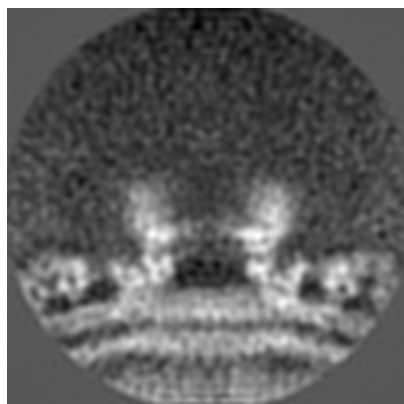

X Index: 64

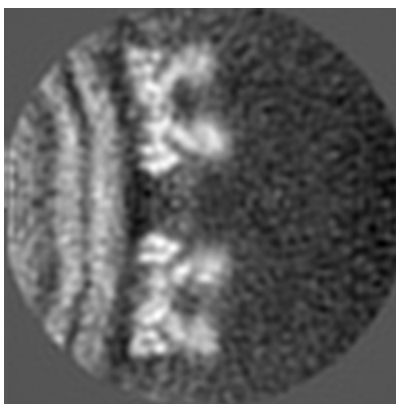

Y Index: 64

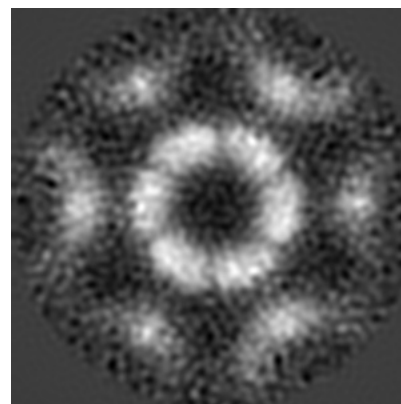

Z Index: 64

The images above show central slices of the map in three orthogonal directions.

6.3 Largest variance slices [\(i\)](#)

6.3.1 Primary map

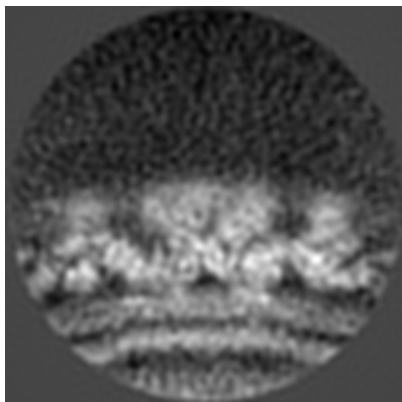

X Index: 82

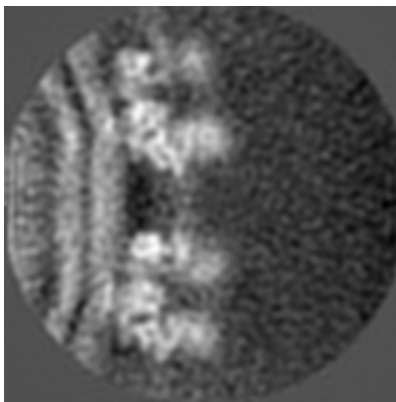

Y Index: 60

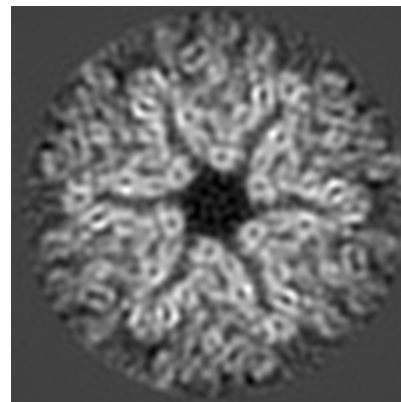

Z Index: 43

The images above show the largest variance slices of the map in three orthogonal directions.

6.4 Orthogonal standard-deviation projections (False-color) [\(i\)](#)

6.4.1 Primary map

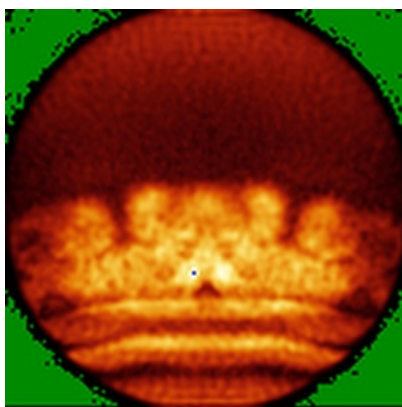

X

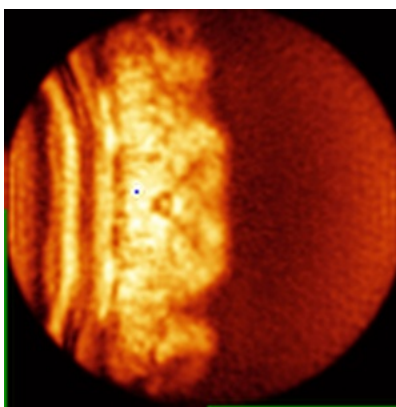

Y

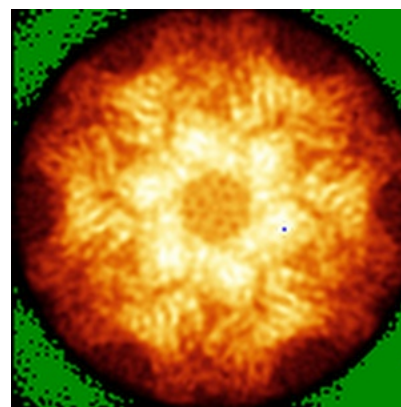

Z

The images above show the map standard deviation projections with false color in three orthogonal directions. Minimum values are shown in green, max in blue, and dark to light orange shades represent small to large values respectively.

6.5 Orthogonal surface views [i](#)

6.5.1 Primary map

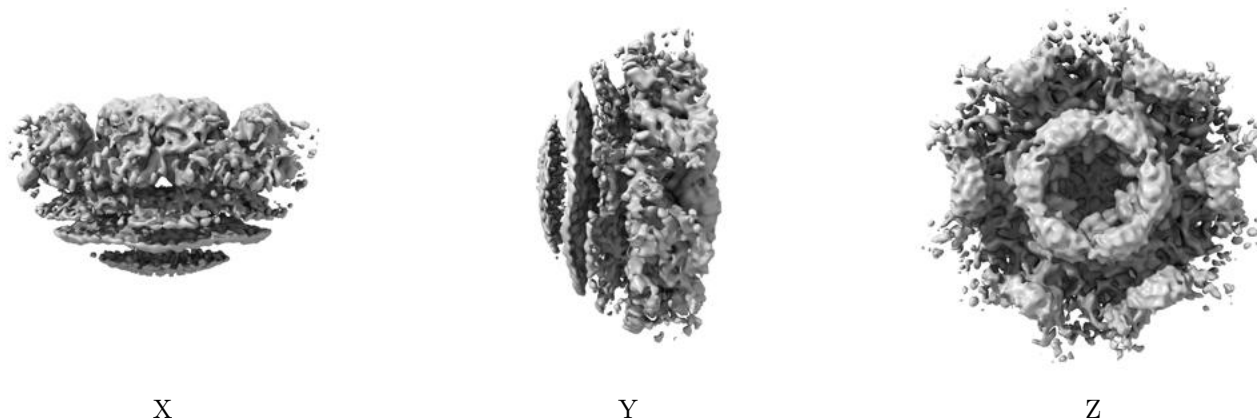

The images above show the 3D surface view of the map at the recommended contour level 0.03. These images, in conjunction with the slice images, may facilitate assessment of whether an appropriate contour level has been provided.

6.6 Mask visualisation [i](#)

This section was not generated. No masks/segmentation were deposited.

7 Map analysis [i](#)

This section contains the results of statistical analysis of the map.

7.1 Map-value distribution [i](#)

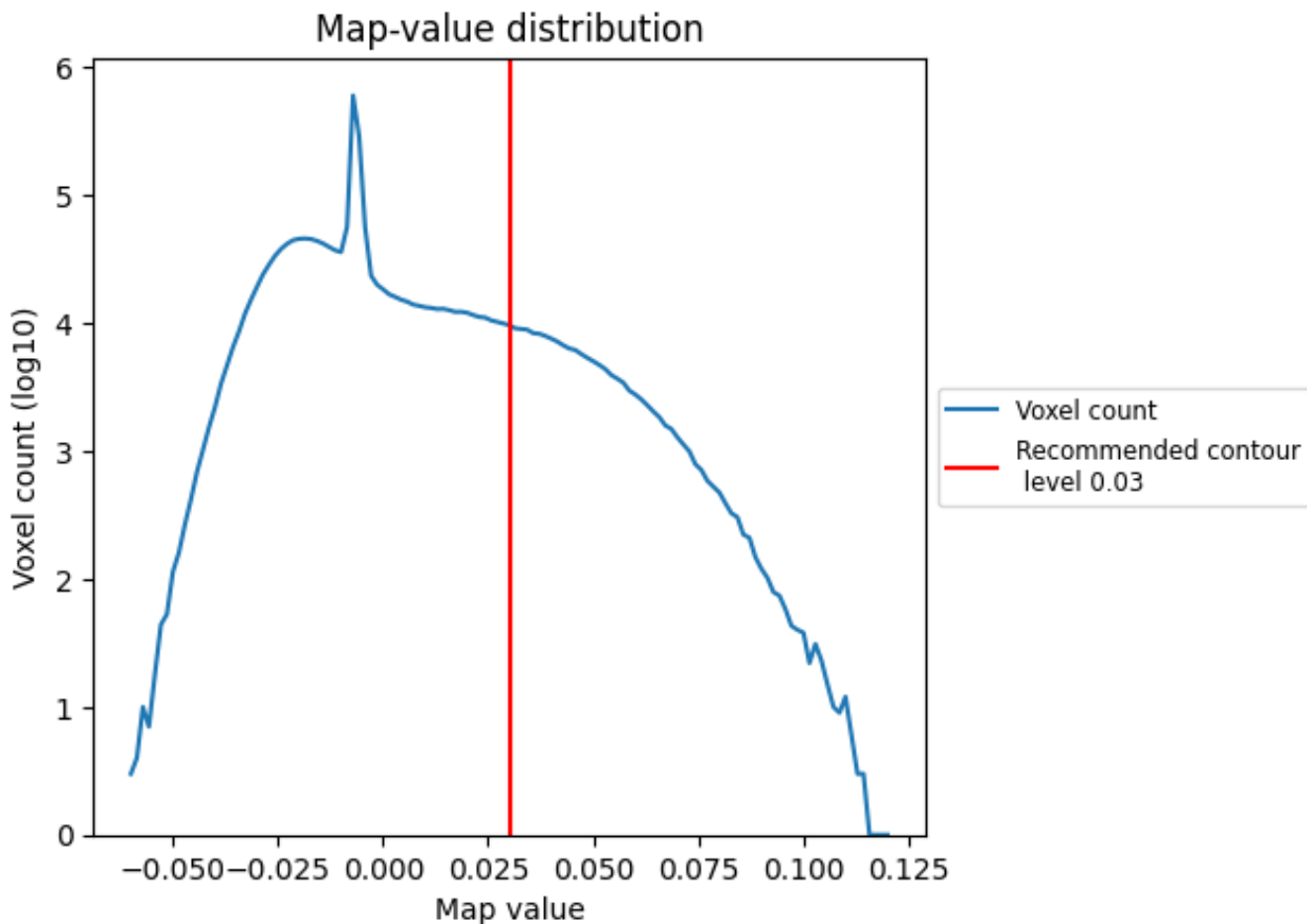

The map-value distribution is plotted in 128 intervals along the x-axis. The y-axis is logarithmic. A spike in this graph at zero usually indicates that the volume has been masked.

7.2 Volume estimate [\(i\)](#)

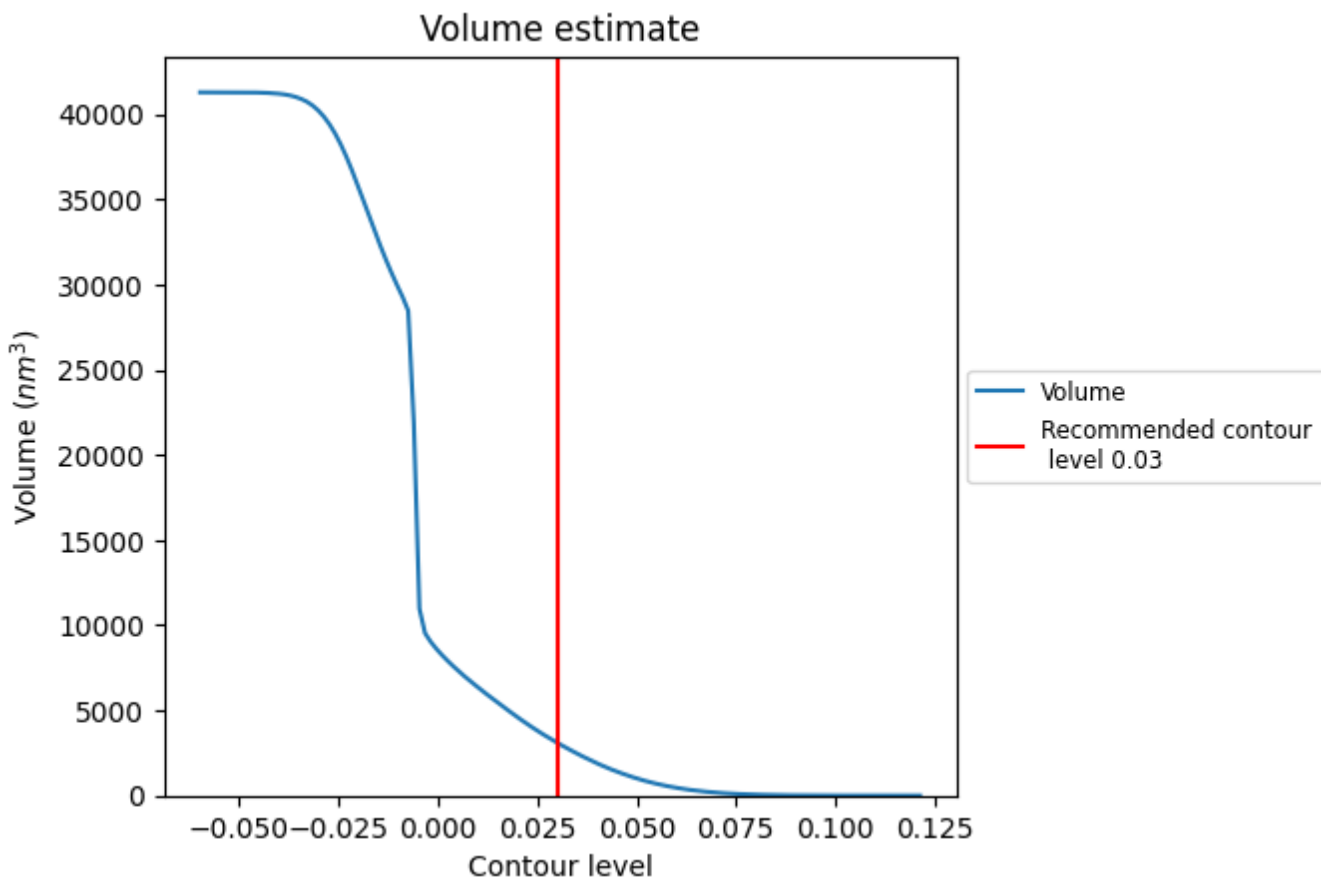

The volume at the recommended contour level is 3102 nm³; this corresponds to an approximate mass of 2802 kDa.

The volume estimate graph shows how the enclosed volume varies with the contour level. The recommended contour level is shown as a vertical line and the intersection between the line and the curve gives the volume of the enclosed surface at the given level.

7.3 Rotationally averaged power spectrum [i](#)

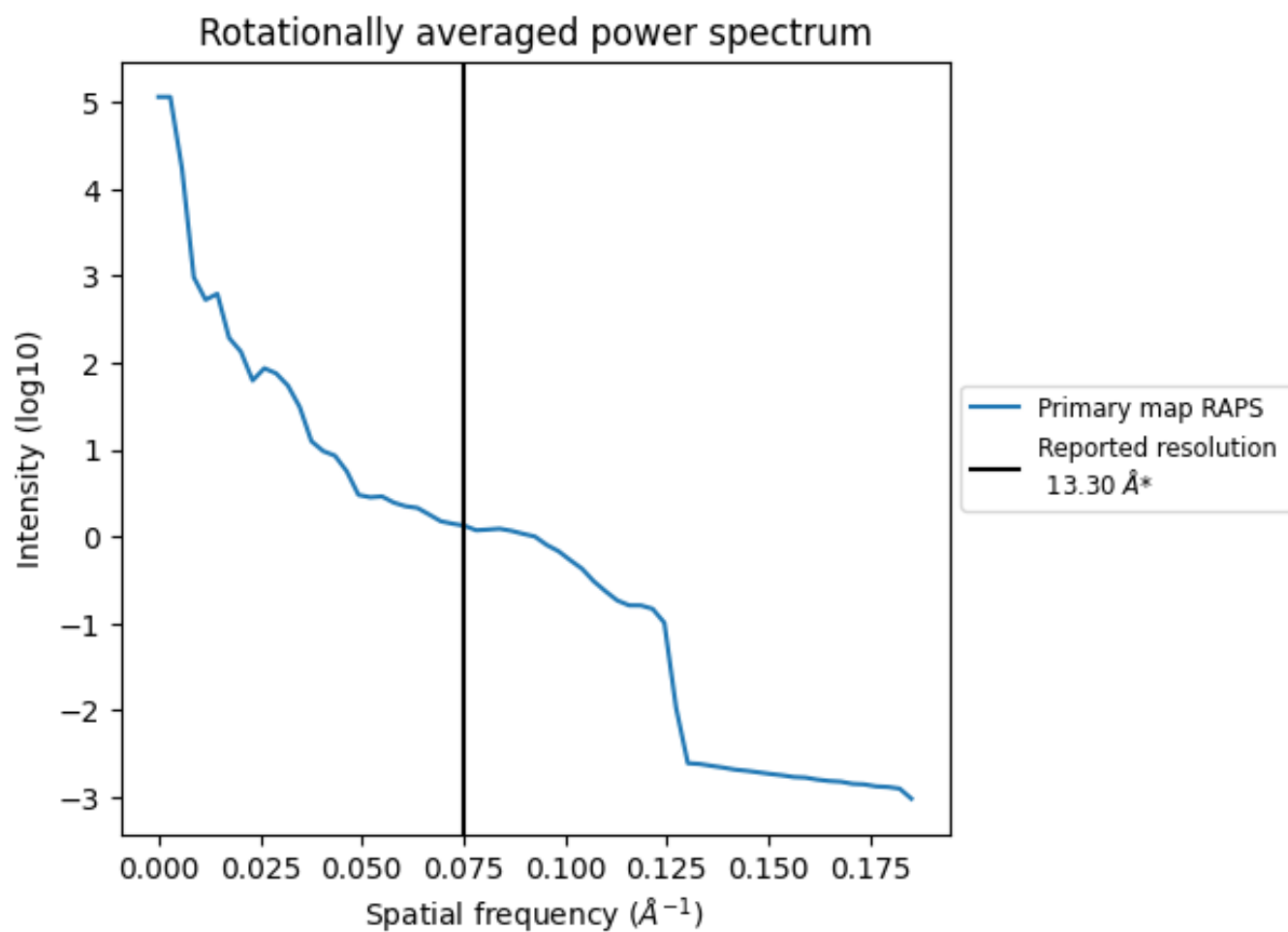

*Reported resolution corresponds to spatial frequency of 0.075 Å⁻¹

8 Fourier-Shell correlation [i](#)

Fourier-Shell Correlation (FSC) is the most commonly used method to estimate the resolution of single-particle and subtomogram-averaged maps. The shape of the curve depends on the imposed symmetry, mask and whether or not the two 3D reconstructions used were processed from a common reference. The reported resolution is shown as a black line. A curve is displayed for the half-bit criterion in addition to lines showing the 0.143 gold standard cut-off and 0.5 cut-off.

8.1 FSC [i](#)

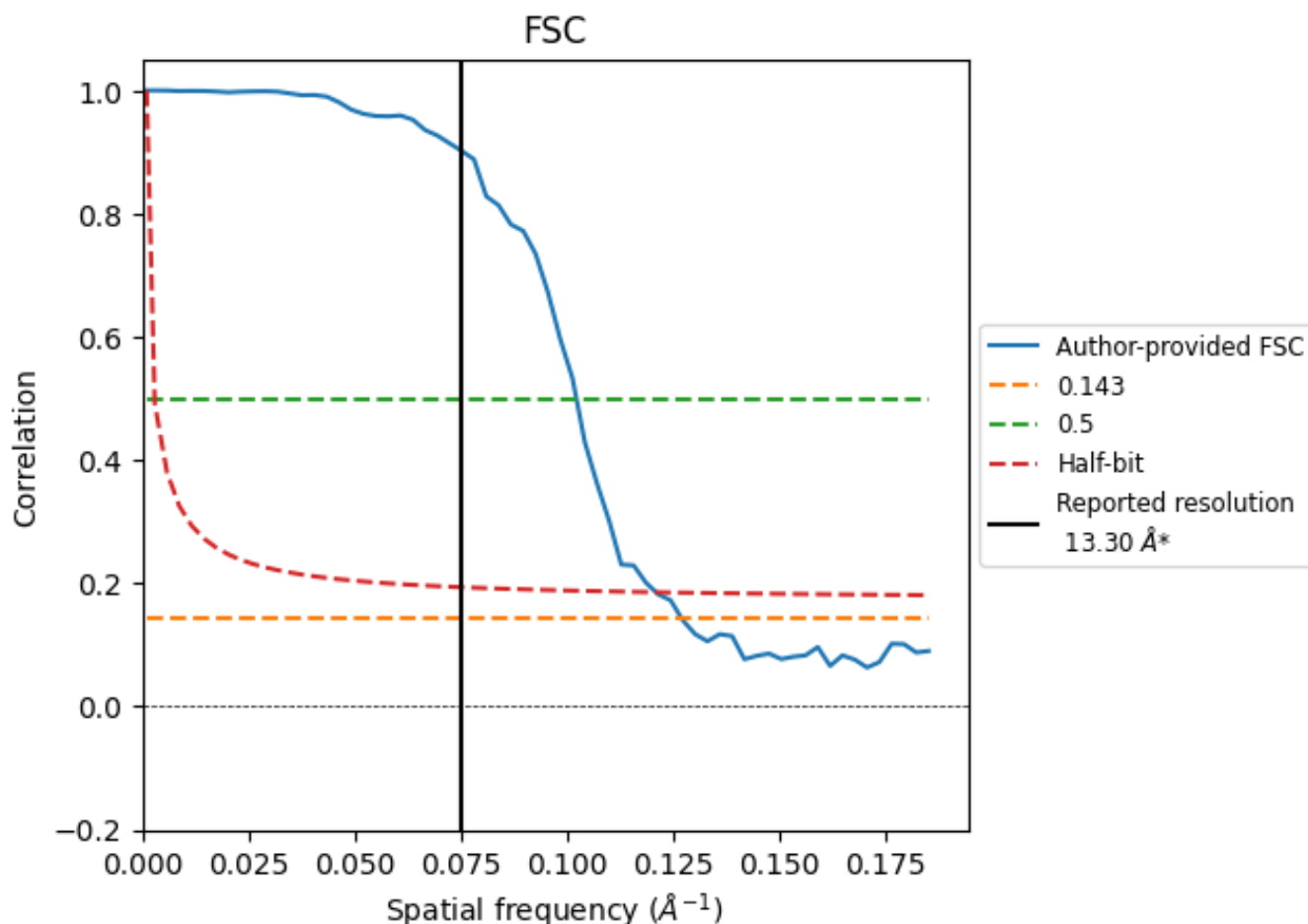

*Reported resolution corresponds to spatial frequency of 0.075 Å⁻¹

8.2 Resolution estimates

Resolution estimate (Å)	Estimation criterion (FSC cut-off)		
	0.143	0.5	Half-bit
Reported by author	13.30	-	-
Author-provided FSC curve	7.87	9.78	8.26
Unmasked-calculated*	-	-	-

*Resolution estimate based on FSC curve calculated by comparison of deposited half-maps. The value from author-provided FSC intersecting FSC 0.143 CUT-OFF 7.87 differs from the reported value 13.3 by more than 10 %

9 Map-model fit [i](#)

This section contains information regarding the fit between EMDB map EMD-4200 and PDB model 6F9E. Per-residue inclusion information can be found in section 3 on page 6.

9.1 Map-model overlay [i](#)

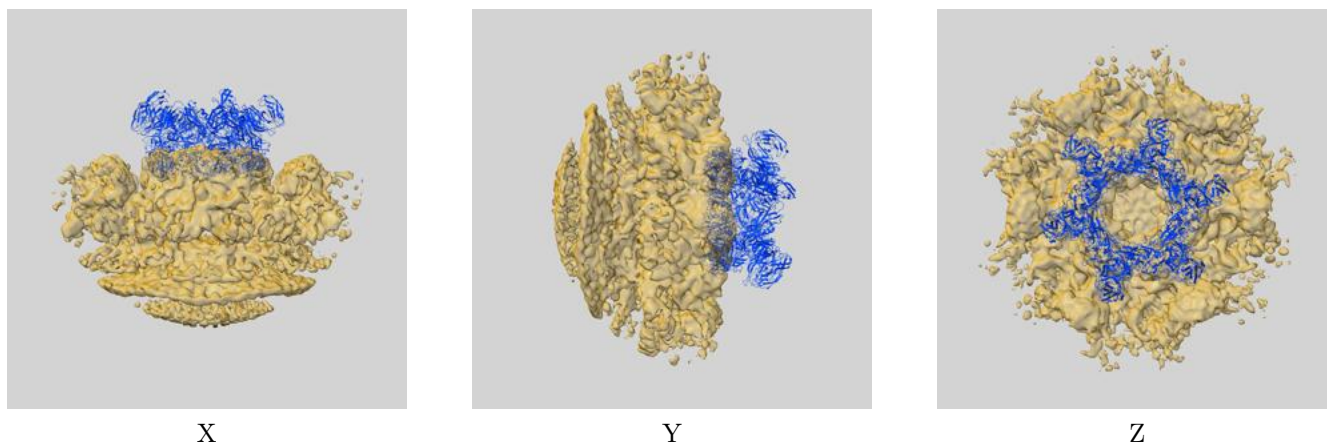

The images above show the 3D surface view of the map at the recommended contour level 0.03 at 50% transparency in yellow overlaid with a ribbon representation of the model coloured in blue. These images allow for the visual assessment of the quality of fit between the atomic model and the map.

9.2 Q-score mapped to coordinate model [i](#)

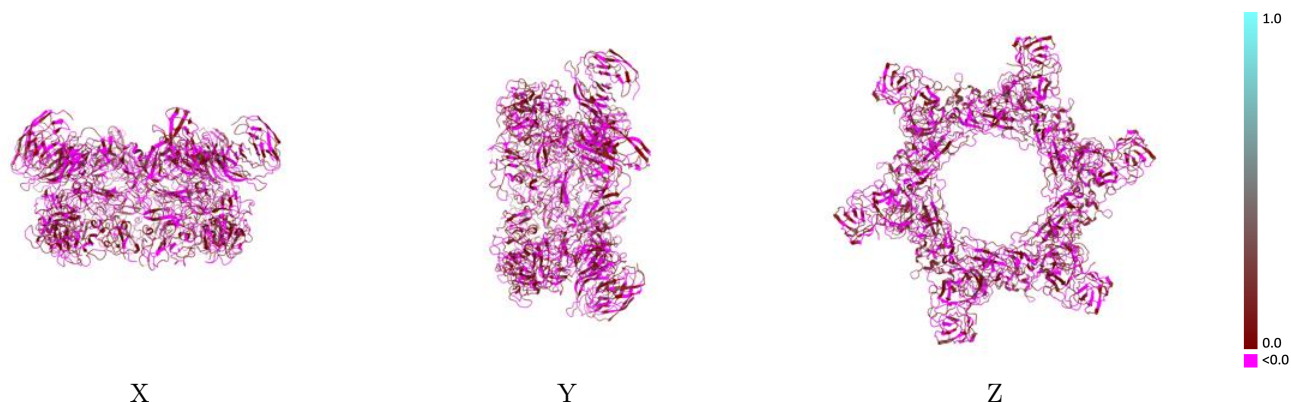

The images above show the model with each residue coloured according to its Q-score. This shows their resolvability in the map with higher Q-score values reflecting better resolvability. Please note: Q-score is calculating the resolvability of atoms, and thus high values are only expected at resolutions at which atoms can be resolved. Low Q-score values may therefore be expected for many entries.

9.3 Atom inclusion mapped to coordinate model [i](#)

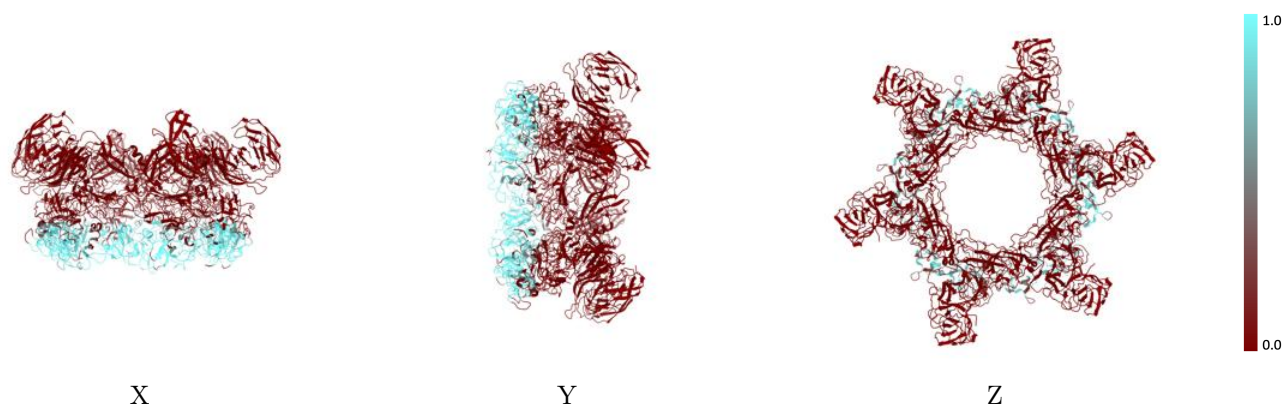

The images above show the model with each residue coloured according to its atom inclusion. This shows to what extent they are inside the map at the recommended contour level (0.03).

9.4 Atom inclusion [i](#)

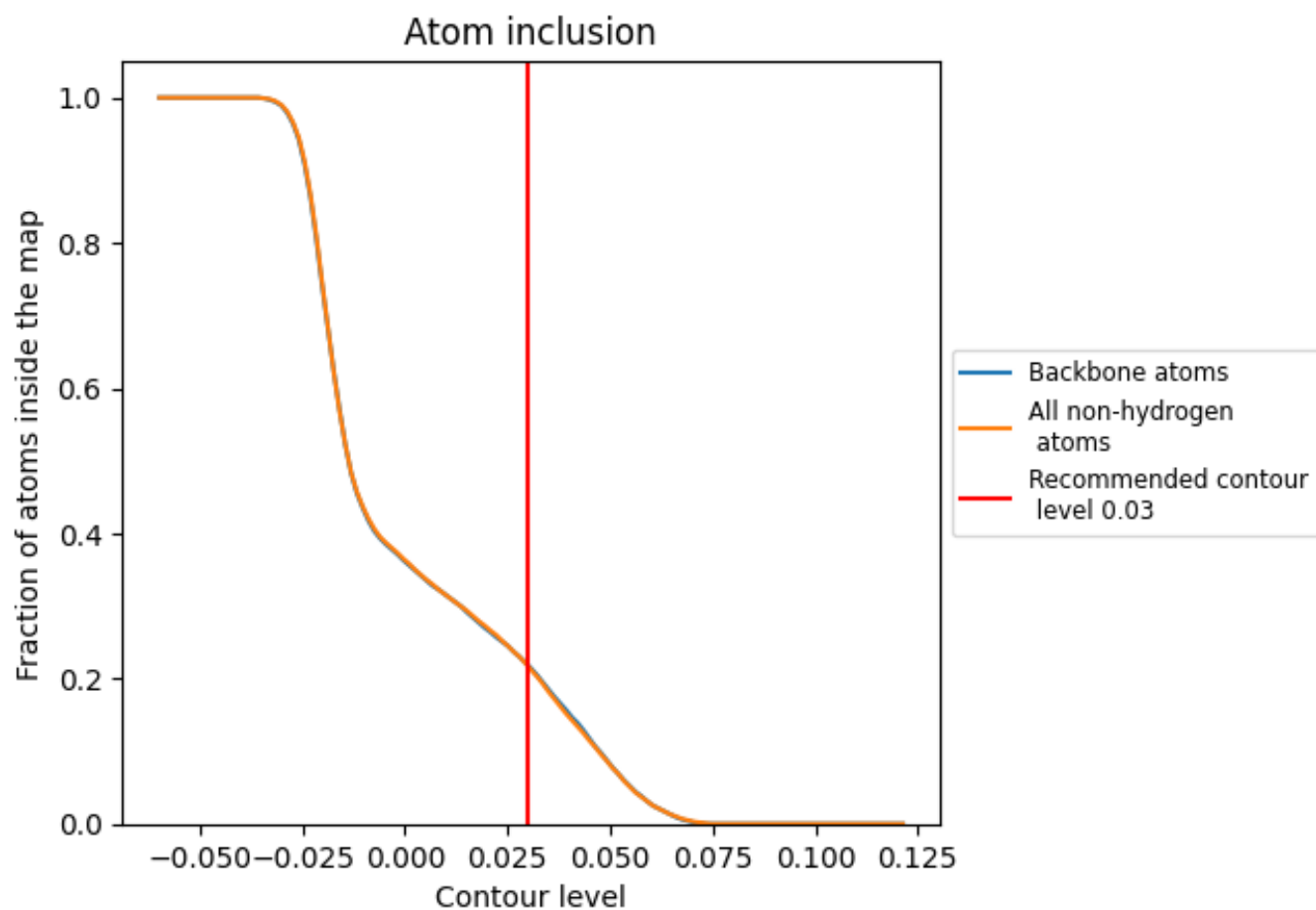

At the recommended contour level, 22% of all backbone atoms, 22% of all non-hydrogen atoms, are inside the map.

9.5 Map-model fit summary [i](#)

The table lists the average atom inclusion at the recommended contour level (0.03) and Q-score for the entire model and for each chain.

Chain	Atom inclusion	Q-score
All	0.2170	0.0090
A	0.5180	0.0220
B	0.0010	0.0060
C	0.4960	0.0190
D	0.0000	0.0010
E	0.5060	0.0260
F	0.0000	-0.0000
G	0.5210	0.0210
H	0.0000	-0.0040
I	0.5380	0.0250
J	0.0010	-0.0020
K	0.5430	0.0180
L	0.0000	-0.0010

