



# wwPDB X-ray Structure Validation Summary Report ⓘ

Mar 7, 2026 – 05:29 AM UTC

PDB ID : 5NTC / pdb\_00005ntc  
Title : Crystal structure of mouse CARM1 in complex with inhibitor SA0678  
Authors : Cura, V.; Marechal, N.; Mailliot, J.; Troffer-Charlier, N.; Hassenboehler, P.;  
Wurtz, J.M.; Bonnefond, L.; Cavarelli, J.  
Deposited on : 2017-04-27  
Resolution : 2.25 Å (reported)

This is a wwPDB X-ray Structure Validation Summary Report for a publicly released PDB entry.

We welcome your comments at [validation@mail.wwpdb.org](mailto:validation@mail.wwpdb.org)

A user guide is available at

<https://www.wwpdb.org/validation/2017/XrayValidationReportHelp>

with specific help available everywhere you see the ⓘ symbol.

The types of validation reports are described at

<http://www.wwpdb.org/validation/2017/FAQs#types>.

---

The following versions of software and data (see [references ⓘ](#)) were used in the production of this report:

MolProbity : 4-5-2 with Phenix2.0  
Mogul : 2022.3.0, CSD as543be (2022)  
Xtriage (Phenix) : 2.0  
EDS : 3.0  
Buster-report : wwPDB partial adaption of 1.1.7 (2018)  
Percentile statistics : 20250101.v01 (using entries in the PDB archive January 1st 2025)  
CCP4 : 9.0.010 (Gargrove)  
Density-Fitness : 1.0.12  
Ideal geometry (proteins) : Engh & Huber (2001)  
Ideal geometry (DNA, RNA) : Parkinson et al. (1996)  
Validation Pipeline (wwPDB-VP) : 2.49

# 1 Overall quality at a glance

The following experimental techniques were used to determine the structure:

*X-RAY DIFFRACTION*

The reported resolution of this entry is 2.25 Å.

Percentile scores (ranging between 0-100) for global validation metrics of the entry are shown in the following graphic. The table shows the number of entries on which the scores are based.

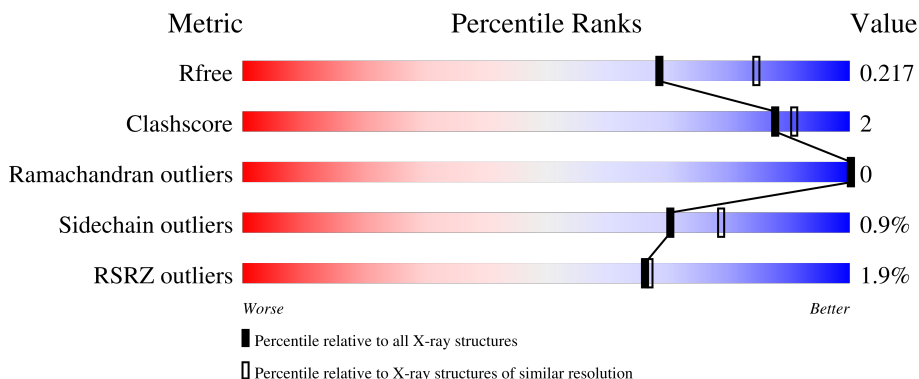

Metric	Whole archive (#Entries)	Similar resolution (#Entries, resolution range(Å))
$R_{free}$	180053	1898 (2.26-2.26)
Clashscore	190562	2005 (2.26-2.26)
Ramachandran outliers	187476	1965 (2.26-2.26)
Sidechain outliers	187428	1966 (2.26-2.26)
RSRZ outliers	180081	1898 (2.26-2.26)

The table below summarises the geometric issues observed across the polymeric chains and their fit to the electron density. The red, orange, yellow and green segments of the lower bar indicate the fraction of residues that contain outliers for  $\geq 3$ , 2, 1 and 0 types of geometric quality criteria respectively. A grey segment represents the fraction of residues that are not modelled. The numeric value for each fraction is indicated below the corresponding segment, with a dot representing fractions  $\leq 5\%$ . The upper red bar (where present) indicates the fraction of residues that have poor fit to the electron density. The numeric value is given above the bar.

Mol	Chain	Length	Quality of chain
1	A	371	 89% 5% 6%
1	B	371	 86% 10%
1	C	371	 87% 6% 6%
1	D	371	 84% 5% 10%

## 2 Entry composition [i](#)

There are 8 unique types of molecules in this entry. The entry contains 22816 atoms, of which 11025 are hydrogens and 0 are deuteriums.

In the tables below, the ZeroOcc column contains the number of atoms modelled with zero occupancy, the AltConf column contains the number of residues with at least one atom in alternate conformation and the Trace column contains the number of residues modelled with at most 2 atoms.

- Molecule 1 is a protein called Histone-arginine methyltransferase CARM1.

Mol	Chain	Residues	Atoms					ZeroOcc	AltConf	Trace	
			Total	C	H	N	O				S
1	A	350	5539	1807	2740	463	515	14	0	2	0
1	B	333	5330	1740	2642	443	490	15	0	2	0
1	C	348	5513	1799	2729	461	510	14	0	2	0
1	D	333	5326	1737	2640	445	489	15	0	2	0

There are 12 discrepancies between the modelled and reference sequences:

Chain	Residue	Modelled	Actual	Comment	Reference
A	127	GLY	-	expression tag	UNP Q9WVG6
A	128	HIS	-	expression tag	UNP Q9WVG6
A	129	MET	-	expression tag	UNP Q9WVG6
B	127	GLY	-	expression tag	UNP Q9WVG6
B	128	HIS	-	expression tag	UNP Q9WVG6
B	129	MET	-	expression tag	UNP Q9WVG6
C	127	GLY	-	expression tag	UNP Q9WVG6
C	128	HIS	-	expression tag	UNP Q9WVG6
C	129	MET	-	expression tag	UNP Q9WVG6
D	127	GLY	-	expression tag	UNP Q9WVG6
D	128	HIS	-	expression tag	UNP Q9WVG6
D	129	MET	-	expression tag	UNP Q9WVG6

- Molecule 2 is 1,2-ETHANEDIOL (CCD ID: EDO) (formula: C<sub>2</sub>H<sub>6</sub>O<sub>2</sub>).



Mol	Chain	Residues	Atoms	ZeroOcc	AltConf
2	A	1	Total C H O 10 2 6 2	0	0
2	A	1	Total C O 4 2 2	0	0
2	A	1	Total C O 4 2 2	0	0
2	B	1	Total C H O 10 2 6 2	0	0
2	B	1	Total C H O 10 2 6 2	0	0
2	B	1	Total C O 4 2 2	0	0
2	B	1	Total C O 4 2 2	0	0
2	B	1	Total C O 4 2 2	0	0
2	C	1	Total C H O 10 2 6 2	0	0
2	C	1	Total C H O 10 2 6 2	0	0
2	C	1	Total C O 4 2 2	0	0
2	C	1	Total C O 4 2 2	0	0
2	D	1	Total C O 4 2 2	0	0

- Molecule 3 is DI(HYDROXYETHYL)ETHER (CCD ID: PEG) (formula: C<sub>4</sub>H<sub>10</sub>O<sub>3</sub>).



Mol	Chain	Residues	Atoms				ZeroOcc	AltConf
			Total	C	H	O		
3	A	1	17	4	10	3	0	0
3	D	1	17	4	10	3	0	0

- Molecule 4 is 1,2-DIMETHOXYETHANE (CCD ID: DXE) (formula:  $C_4H_{10}O_2$ ).

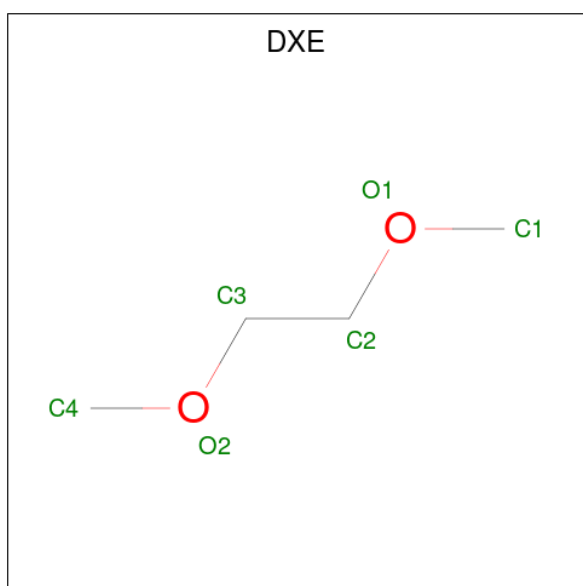

Mol	Chain	Residues	Atoms				ZeroOcc	AltConf
			Total	C	H	O		
4	A	1	16	4	10	2	0	0
4	C	1	16	4	10	2	0	0

- Molecule 5 is 1-METHOXY-2-(2-METHOXYETHOXY)ETHANE (CCD ID: M2M) (formula:  $C_6H_{14}O_3$ ).

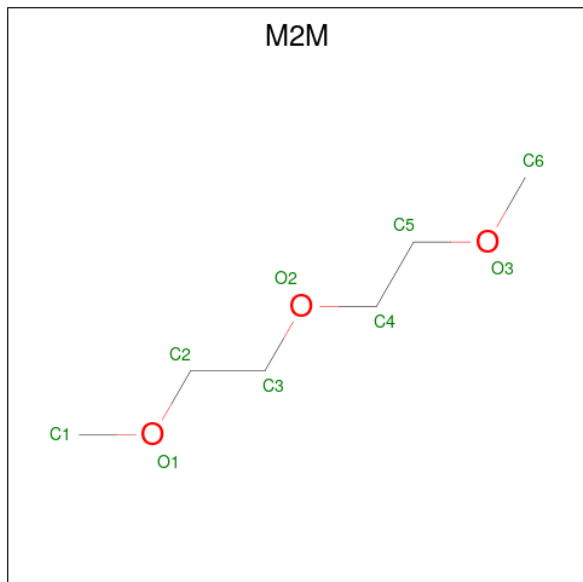

Mol	Chain	Residues	Atoms				ZeroOcc	AltConf
			Total	C	H	O		
5	A	1	23	6	14	3	0	0

- Molecule 6 is 2-[3-(2-HYDROXY-1,1-DIHYDROXYMETHYL-ETHYLAMINO)-PROPYLAMINO]-2-HYDROXYMETHYL-PROPANE-1,3-DIOL (CCD ID: B3P) (formula:  $C_{11}H_{26}N_2O_6$ ).

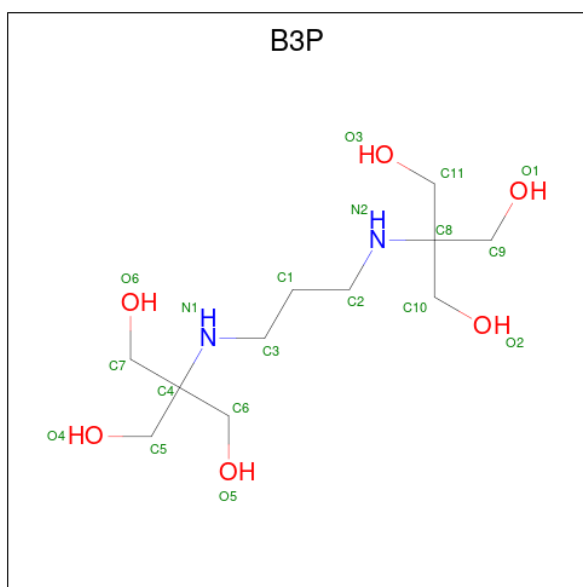

Mol	Chain	Residues	Atoms				ZeroOcc	AltConf	
6	A	1	Total	C	H	N	O	0	0
			45	11	26	2	6		
6	B	1	Total	C	H	N	O	0	0
			45	11	26	2	6		
6	D	1	Total	C	H	N	O	0	0
			45	11	26	2	6		

- Molecule 7 is [(2 {R},3 {S},4 {R},5 {R})-5-(6-aminopurin-9-yl)-3,4-bis(oxidanyl)oxolan-2-yl]methyl-(2-azaniumylethyl)-[(3 {S})-3-azaniumyl-4-oxidanyl-4-oxidanylidene-butyl]azanium (CCD ID: 6L7) (formula: C<sub>16</sub>H<sub>29</sub>N<sub>8</sub>O<sub>5</sub>).

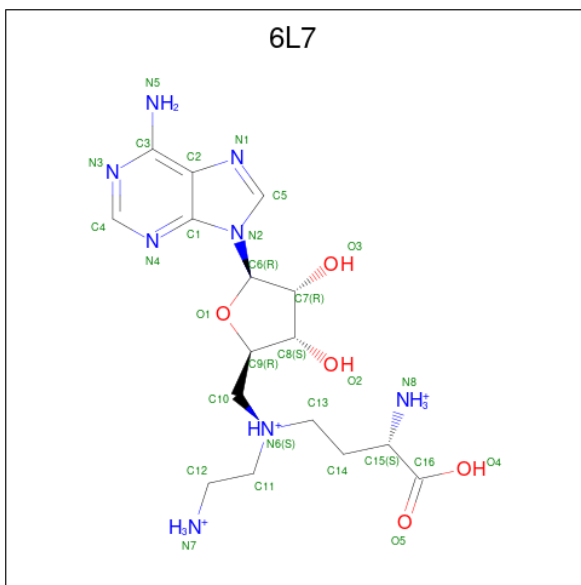

Mol	Chain	Residues	Atoms				ZeroOcc	AltConf	
7	A	1	Total	C	H	N	O	0	0
			57	16	28	8	5		
7	B	1	Total	C	H	N	O	0	0
			57	16	28	8	5		
7	C	1	Total	C	H	N	O	0	0
			57	16	28	8	5		
7	D	1	Total	C	H	N	O	0	0
			57	16	28	8	5		

- Molecule 8 is water.

Mol	Chain	Residues	Atoms		ZeroOcc	AltConf
8	A	216	Total	O	0	0
			216	216		
8	B	164	Total	O	0	0
			164	164		

Continued on next page...

*Continued from previous page...*

<b>Mol</b>	<b>Chain</b>	<b>Residues</b>	<b>Atoms</b>	<b>ZeroOcc</b>	<b>AltConf</b>
8	C	97	Total O 97 97	0	0
8	D	97	Total O 97 97	0	0

### 3 Residue-property plots [i](#)

These plots are drawn for all protein, RNA, DNA and oligosaccharide chains in the entry. The first graphic for a chain summarises the proportions of the various outlier classes displayed in the second graphic. The second graphic shows the sequence view annotated by issues in geometry and electron density. Residues are color-coded according to the number of geometric quality criteria for which they contain at least one outlier: green = 0, yellow = 1, orange = 2 and red = 3 or more. A red dot above a residue indicates a poor fit to the electron density ( $RSRZ > 2$ ). Stretches of 2 or more consecutive residues without any outlier are shown as a green connector. Residues present in the sample, but not in the model, are shown in grey.

- Molecule 1: Histone-arginine methyltransferase CARM1

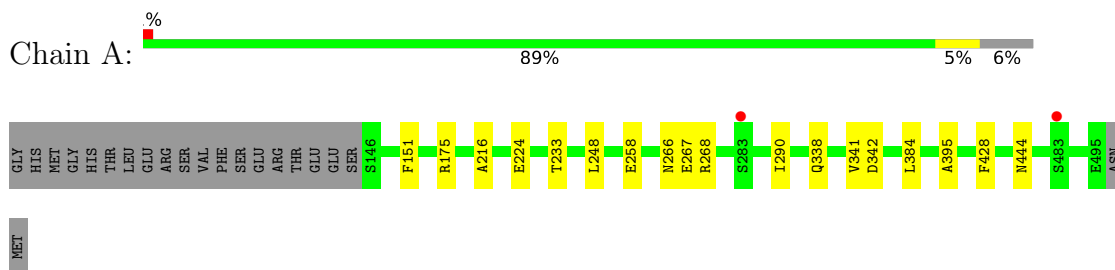

- Molecule 1: Histone-arginine methyltransferase CARM1

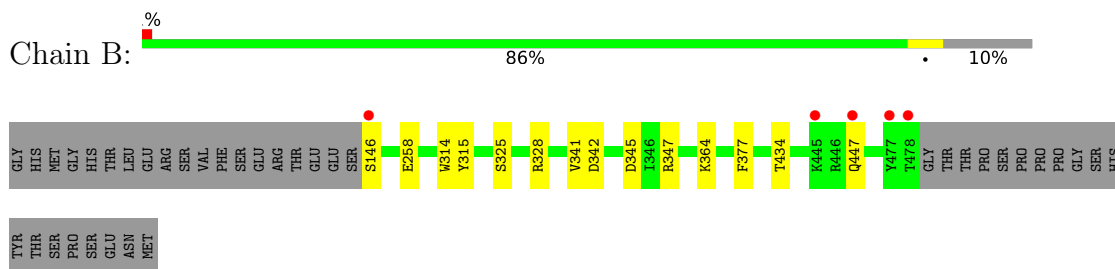

- Molecule 1: Histone-arginine methyltransferase CARM1

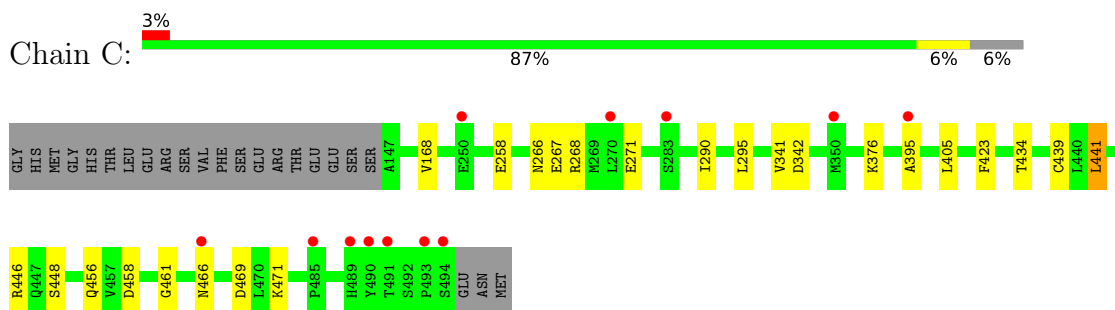

- Molecule 1: Histone-arginine methyltransferase CARM1

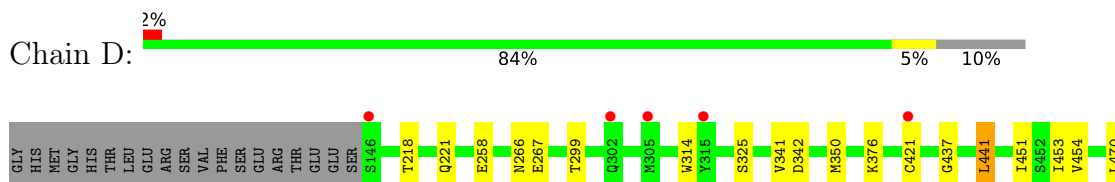

1477	GLY
1478	THR
	THR
	PRO
	SER
	PRO
	PRO
	PRO
	GLY
	SER
	HIS
	TYR
	THR
	SER
	PRO
	PRO
	SER
	GLU
	ASN
	MET

## 4 Data and refinement statistics i

Property	Value	Source
Space group	P 21 21 2	Depositor
Cell constants a, b, c, $\alpha$ , $\beta$ , $\gamma$	74.91Å 99.15Å 206.87Å 90.00° 90.00° 90.00°	Depositor
Resolution (Å)	19.94 – 2.25 19.94 – 2.25	Depositor EDS
% Data completeness (in resolution range)	99.7 (19.94-2.25) 99.2 (19.94-2.25)	Depositor EDS
$R_{merge}$	(Not available)	Depositor
$R_{sym}$	0.09	Depositor
$\langle I/\sigma(I) \rangle$ <sup>1</sup>	5.07 (at 2.26Å)	Xtrriage
Refinement program	PHENIX dev_1951	Depositor
R, $R_{free}$	0.178 , 0.216 0.179 , 0.217	Depositor DCC
$R_{free}$ test set	3640 reflections (4.94%)	wwPDB-VP
Wilson B-factor (Å <sup>2</sup> )	35.4	Xtrriage
Anisotropy	0.238	Xtrriage
Bulk solvent $k_{sol}$ (e/Å <sup>3</sup> ), $B_{sol}$ (Å <sup>2</sup> )	0.37 , 47.6	EDS
L-test for twinning <sup>2</sup>	$\langle  L  \rangle = 0.48$ , $\langle L^2 \rangle = 0.31$	Xtrriage
Estimated twinning fraction	No twinning to report.	Xtrriage
$F_o, F_c$ correlation	0.96	EDS
Total number of atoms	22816	wwPDB-VP
Average B, all atoms (Å <sup>2</sup> )	48.0	wwPDB-VP

Xtrriage's analysis on translational NCS is as follows: *The analyses of the Patterson function reveals a significant off-origin peak that is 44.10 % of the origin peak, indicating pseudo-translational symmetry. The chance of finding a peak of this or larger height randomly in a structure without pseudo-translational symmetry is equal to 1.6017e-04. The detected translational NCS is most likely also responsible for the elevated intensity ratio.*

<sup>1</sup>Intensities estimated from amplitudes.

<sup>2</sup>Theoretical values of  $\langle |L| \rangle$ ,  $\langle L^2 \rangle$  for acentric reflections are 0.5, 0.333 respectively for untwinned datasets, and 0.375, 0.2 for perfectly twinned datasets.

## 5 Model quality [i](#)

### 5.1 Standard geometry [i](#)

Bond lengths and bond angles in the following residue types are not validated in this section: EDO, DXE, 6L7, M2M, B3P, PEG

The Z score for a bond length (or angle) is the number of standard deviations the observed value is removed from the expected value. A bond length (or angle) with  $|Z| > 5$  is considered an outlier worth inspection. RMSZ is the root-mean-square of all Z scores of the bond lengths (or angles).

Mol	Chain	Bond lengths		Bond angles	
		RMSZ	# Z  >5	RMSZ	# Z  >5
1	A	0.37	0/2892	0.72	2/3928 (0.1%)
1	B	0.38	0/2758	0.71	0/3739
1	C	0.38	0/2877	0.72	0/3908
1	D	0.38	0/2756	0.72	0/3736
All	All	0.38	0/11283	0.72	2/15311 (0.0%)

There are no bond length outliers.

All (2) bond angle outliers are listed below:

Mol	Chain	Res	Type	Atoms	Z	Observed(°)	Ideal(°)
1	A	338	GLN	CA-C-N	-5.00	114.61	119.76
1	A	338	GLN	C-N-CA	-5.00	114.61	119.76

There are no chirality outliers.

There are no planarity outliers.

### 5.2 Too-close contacts [i](#)

In the following table, the Non-H and H(model) columns list the number of non-hydrogen atoms and hydrogen atoms in the chain respectively. The H(added) column lists the number of hydrogen atoms added and optimized by MolProbity. The Clashes column lists the number of clashes within the asymmetric unit, whereas Symm-Clashes lists symmetry-related clashes.

Mol	Chain	Non-H	H(model)	H(added)	Clashes	Symm-Clashes
1	A	2799	2740	2729	9	0
1	B	2688	2642	2640	8	0
1	C	2784	2729	2718	14	0
1	D	2686	2640	2638	12	0
2	A	12	6	18	0	0

*Continued on next page...*

Continued from previous page...

Mol	Chain	Non-H	H(model)	H(added)	Clashes	Symm-Clashes
2	B	20	12	30	1	0
2	C	16	12	24	1	0
2	D	4	0	6	0	0
3	A	7	10	10	0	0
3	D	7	10	10	0	0
4	A	6	10	10	0	0
4	C	6	10	10	0	0
5	A	9	14	14	0	0
6	A	19	26	26	1	0
6	B	19	26	26	0	0
6	D	19	26	26	0	0
7	A	29	28	0	0	0
7	B	29	28	0	0	0
7	C	29	28	0	0	0
7	D	29	28	0	0	0
8	A	216	0	0	2	0
8	B	164	0	0	0	0
8	C	97	0	0	1	0
8	D	97	0	0	0	0
All	All	11791	11025	10935	44	0

The all-atom clashscore is defined as the number of clashes found per 1000 atoms (including hydrogen atoms). The all-atom clashscore for this structure is 2.

The worst 5 of 44 close contacts within the same asymmetric unit are listed below, sorted by their clash magnitude.

Atom-1	Atom-2	Interatomic distance (Å)	Clash overlap (Å)
1:C:446:ARG:NH2	1:C:469:ASP:OD1	1.97	0.98
1:A:224:GLU:OE1	8:A:601:HOH:O	2.08	0.72
1:B:364:LYS:HB3	2:B:504:EDO:H12	1.74	0.70
1:A:267:GLU:O	6:A:507:B3P:O3	2.12	0.68
1:C:268:ARG:NH1	1:C:271:GLU:OE2	2.37	0.58

There are no symmetry-related clashes.

## 5.3 Torsion angles [i](#)

### 5.3.1 Protein backbone [i](#)

In the following table, the Percentiles column shows the percent Ramachandran outliers of the chain as a percentile score with respect to all X-ray entries followed by that with respect to entries of similar resolution.

The Analysed column shows the number of residues for which the backbone conformation was analysed, and the total number of residues.

Mol	Chain	Analysed	Favoured	Allowed	Outliers	Percentiles	
1	A	350/371 (94%)	341 (97%)	9 (3%)	0	100	100
1	B	333/371 (90%)	324 (97%)	9 (3%)	0	100	100
1	C	348/371 (94%)	338 (97%)	10 (3%)	0	100	100
1	D	333/371 (90%)	322 (97%)	11 (3%)	0	100	100
All	All	1364/1484 (92%)	1325 (97%)	39 (3%)	0	100	100

There are no Ramachandran outliers to report.

### 5.3.2 Protein sidechains [i](#)

In the following table, the Percentiles column shows the percent sidechain outliers of the chain as a percentile score with respect to all X-ray entries followed by that with respect to entries of similar resolution.

The Analysed column shows the number of residues for which the sidechain conformation was analysed, and the total number of residues.

Mol	Chain	Analysed	Rotameric	Outliers	Percentiles	
1	A	306/323 (95%)	303 (99%)	3 (1%)	68	77
1	B	291/323 (90%)	290 (100%)	1 (0%)	86	90
1	C	304/323 (94%)	300 (99%)	4 (1%)	61	72
1	D	291/323 (90%)	288 (99%)	3 (1%)	68	77
All	All	1192/1292 (92%)	1181 (99%)	11 (1%)	70	79

5 of 11 residues with a non-rotameric sidechain are listed below:

Mol	Chain	Res	Type
1	C	441	LEU
1	D	258	GLU
1	D	441	LEU

*Continued on next page...*

*Continued from previous page...*

Mol	Chain	Res	Type
1	D	376	LYS
1	C	258	GLU

Sometimes sidechains can be flipped to improve hydrogen bonding and reduce clashes. 5 of 15 such sidechains are listed below:

Mol	Chain	Res	Type
1	C	316	GLN
1	D	381	HIS
1	C	456	GLN
1	D	456	GLN
1	D	162	ASN

### 5.3.3 RNA [i](#)

There are no RNA molecules in this entry.

## 5.4 Non-standard residues in protein, DNA, RNA chains [i](#)

There are no non-standard protein/DNA/RNA residues in this entry.

## 5.5 Carbohydrates [i](#)

There are no oligosaccharides in this entry.

## 5.6 Ligand geometry [i](#)

25 ligands are modelled in this entry.

In the following table, the Counts columns list the number of bonds (or angles) for which Mogul statistics could be retrieved, the number of bonds (or angles) that are observed in the model and the number of bonds (or angles) that are defined in the Chemical Component Dictionary. The Link column lists molecule types, if any, to which the group is linked. The Z score for a bond length (or angle) is the number of standard deviations the observed value is removed from the expected value. A bond length (or angle) with  $|Z| > 2$  is considered an outlier worth inspection. RMSZ is the root-mean-square of all Z scores of the bond lengths (or angles).

Mol	Type	Chain	Res	Link	Bond lengths			Bond angles		
					Counts	RMSZ	$\# Z  > 2$	Counts	RMSZ	$\# Z  > 2$
2	EDO	A	502	-	3,3,3	0.44	0	2,2,2	0.53	0
4	DXE	A	505	-	5,5,5	0.43	0	4,4,4	0.31	0

Mol	Type	Chain	Res	Link	Bond lengths			Bond angles		
					Counts	RMSZ	# Z  > 2	Counts	RMSZ	# Z  > 2
7	6L7	C	506	-	30,31,31	0.72	0	39,44,44	0.68	2 (5%)
3	PEG	D	502	-	6,6,6	0.48	0	5,5,5	0.45	0
2	EDO	C	501	-	3,3,3	0.45	0	2,2,2	0.51	0
2	EDO	B	502	-	3,3,3	0.44	0	2,2,2	0.51	0
2	EDO	C	504	-	3,3,3	0.44	0	2,2,2	0.50	0
6	B3P	B	506	-	18,18,18	0.20	0	23,23,23	0.43	0
2	EDO	A	503	-	3,3,3	0.44	0	2,2,2	0.52	0
7	6L7	A	508	-	30,31,31	0.64	0	39,44,44	0.85	2 (5%)
2	EDO	C	503	-	3,3,3	0.44	0	2,2,2	0.51	0
7	6L7	B	507	-	30,31,31	0.67	0	39,44,44	0.91	2 (5%)
2	EDO	B	504	-	3,3,3	0.44	0	2,2,2	0.50	0
6	B3P	A	507	-	18,18,18	0.29	0	23,23,23	0.46	0
6	B3P	D	503	-	18,18,18	0.32	0	23,23,23	0.44	0
2	EDO	A	501	-	3,3,3	0.45	0	2,2,2	0.49	0
2	EDO	B	501	-	3,3,3	0.44	0	2,2,2	0.52	0
5	M2M	A	506	-	8,8,8	0.59	0	7,7,7	0.46	0
2	EDO	B	503	-	3,3,3	0.43	0	2,2,2	0.52	0
2	EDO	B	505	-	3,3,3	0.44	0	2,2,2	0.50	0
2	EDO	C	502	-	3,3,3	0.45	0	2,2,2	0.57	0
4	DXE	C	505	-	5,5,5	0.45	0	4,4,4	0.26	0
7	6L7	D	504	-	30,31,31	0.65	0	39,44,44	0.64	1 (2%)
2	EDO	D	501	-	3,3,3	0.44	0	2,2,2	0.52	0
3	PEG	A	504	-	6,6,6	0.48	0	5,5,5	0.60	0

In the following table, the Chirals column lists the number of chiral outliers, the number of chiral centers analysed, the number of these observed in the model and the number defined in the Chemical Component Dictionary. Similar counts are reported in the Torsion and Rings columns. '-' means no outliers of that kind were identified.

Mol	Type	Chain	Res	Link	Chirals	Torsions	Rings
2	EDO	A	502	-	-	1/1/1/1	-
4	DXE	A	505	-	-	3/3/3/3	-
7	6L7	C	506	-	-	11/20/36/36	0/3/3/3
3	PEG	D	502	-	-	1/4/4/4	-
2	EDO	C	501	-	-	0/1/1/1	-
2	EDO	B	502	-	-	1/1/1/1	-
2	EDO	C	504	-	-	1/1/1/1	-
6	B3P	B	506	-	-	6/28/28/28	-
2	EDO	A	503	-	-	1/1/1/1	-
7	6L7	A	508	-	-	10/20/36/36	0/3/3/3
2	EDO	C	503	-	-	0/1/1/1	-

Continued on next page...

Continued from previous page...

Mol	Type	Chain	Res	Link	Chirals	Torsions	Rings
7	6L7	B	507	-	-	11/20/36/36	0/3/3/3
2	EDO	B	504	-	-	0/1/1/1	-
6	B3P	A	507	-	-	5/28/28/28	-
6	B3P	D	503	-	-	7/28/28/28	-
2	EDO	A	501	-	-	1/1/1/1	-
2	EDO	B	501	-	-	1/1/1/1	-
5	M2M	A	506	-	-	4/6/6/6	-
2	EDO	B	503	-	-	0/1/1/1	-
2	EDO	B	505	-	-	0/1/1/1	-
2	EDO	C	502	-	-	1/1/1/1	-
4	DXE	C	505	-	-	1/3/3/3	-
7	6L7	D	504	-	-	7/20/36/36	0/3/3/3
2	EDO	D	501	-	-	0/1/1/1	-
3	PEG	A	504	-	-	4/4/4/4	-

There are no bond length outliers.

The worst 5 of 7 bond angle outliers are listed below:

Mol	Chain	Res	Type	Atoms	Z	Observed(°)	Ideal(°)
7	B	507	6L7	C13-N6-C10	3.32	119.65	111.89
7	B	507	6L7	C12-C11-N6	3.02	121.31	113.39
7	A	508	6L7	C13-N6-C10	2.90	118.65	111.89
7	A	508	6L7	C12-C11-N6	2.83	120.81	113.39
7	C	506	6L7	C12-C11-N6	2.57	120.15	113.39

There are no chirality outliers.

5 of 77 torsion outliers are listed below:

Mol	Chain	Res	Type	Atoms
6	A	507	B3P	N1-C4-C7-O6
6	A	507	B3P	C5-C4-C7-O6
6	A	507	B3P	C6-C4-C7-O6
6	B	506	B3P	C5-C4-N1-C3
6	B	506	B3P	C6-C4-N1-C3

There are no ring outliers.

3 monomers are involved in 3 short contacts:

Mol	Chain	Res	Type	Clashes	Symm-Clashes
2	C	504	EDO	1	0
2	B	504	EDO	1	0
6	A	507	B3P	1	0

The following is a two-dimensional graphical depiction of Mogul quality analysis of bond lengths, bond angles, torsion angles, and ring geometry for all instances of the Ligand of Interest. In addition, ligands with molecular weight > 250 and outliers as shown on the validation Tables will also be included. For torsion angles, if less than 5% of the Mogul distribution of torsion angles is within 10 degrees of the torsion angle in question, then that torsion angle is considered an outlier. Any bond that is central to one or more torsion angles identified as an outlier by Mogul will be highlighted in the graph. For rings, the root-mean-square deviation (RMSD) between the ring in question and similar rings identified by Mogul is calculated over all ring torsion angles. If the average RMSD is greater than 60 degrees and the minimal RMSD between the ring in question and any Mogul-identified rings is also greater than 60 degrees, then that ring is considered an outlier. The outliers are highlighted in purple. The color gray indicates Mogul did not find sufficient equivalents in the CSD to analyse the geometry.

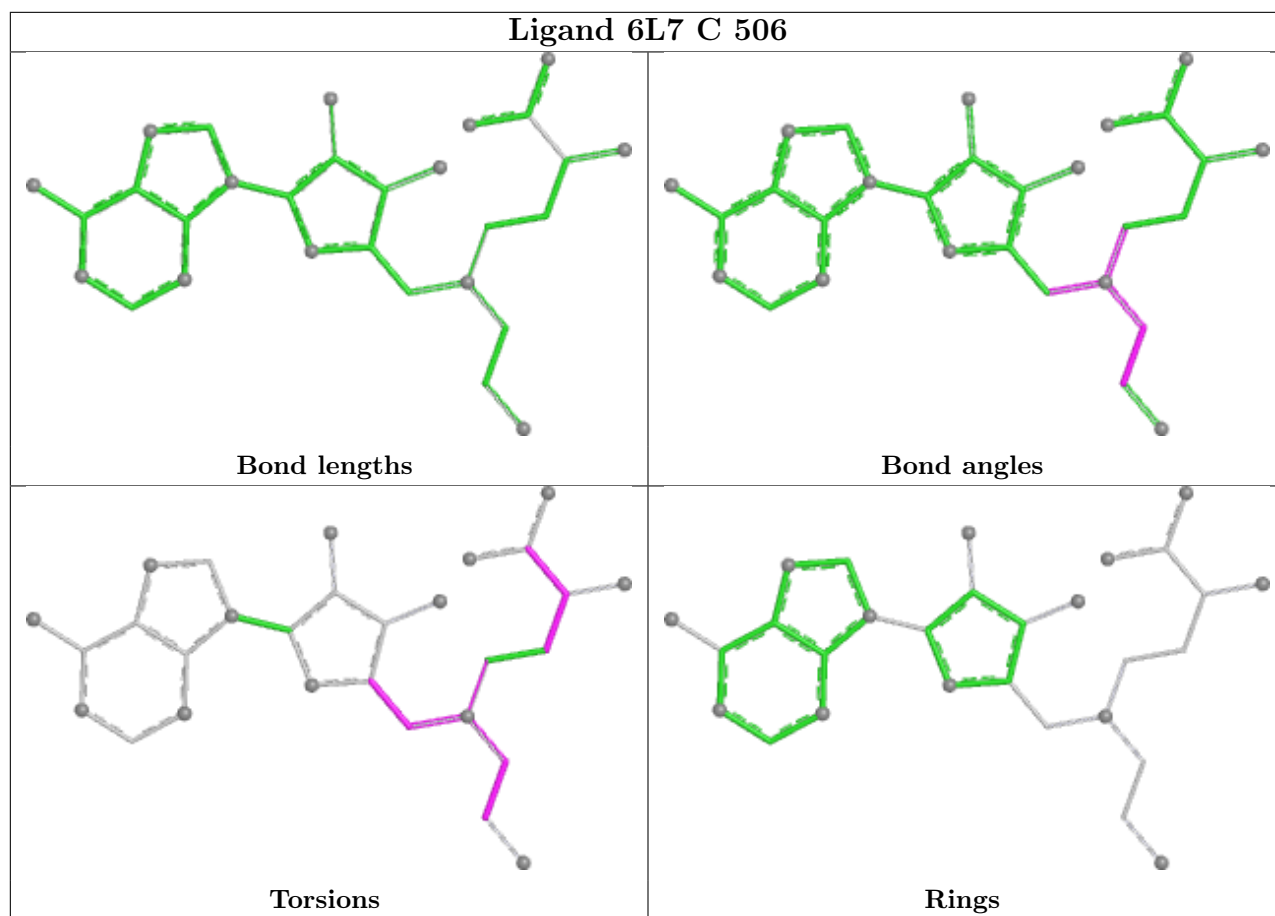

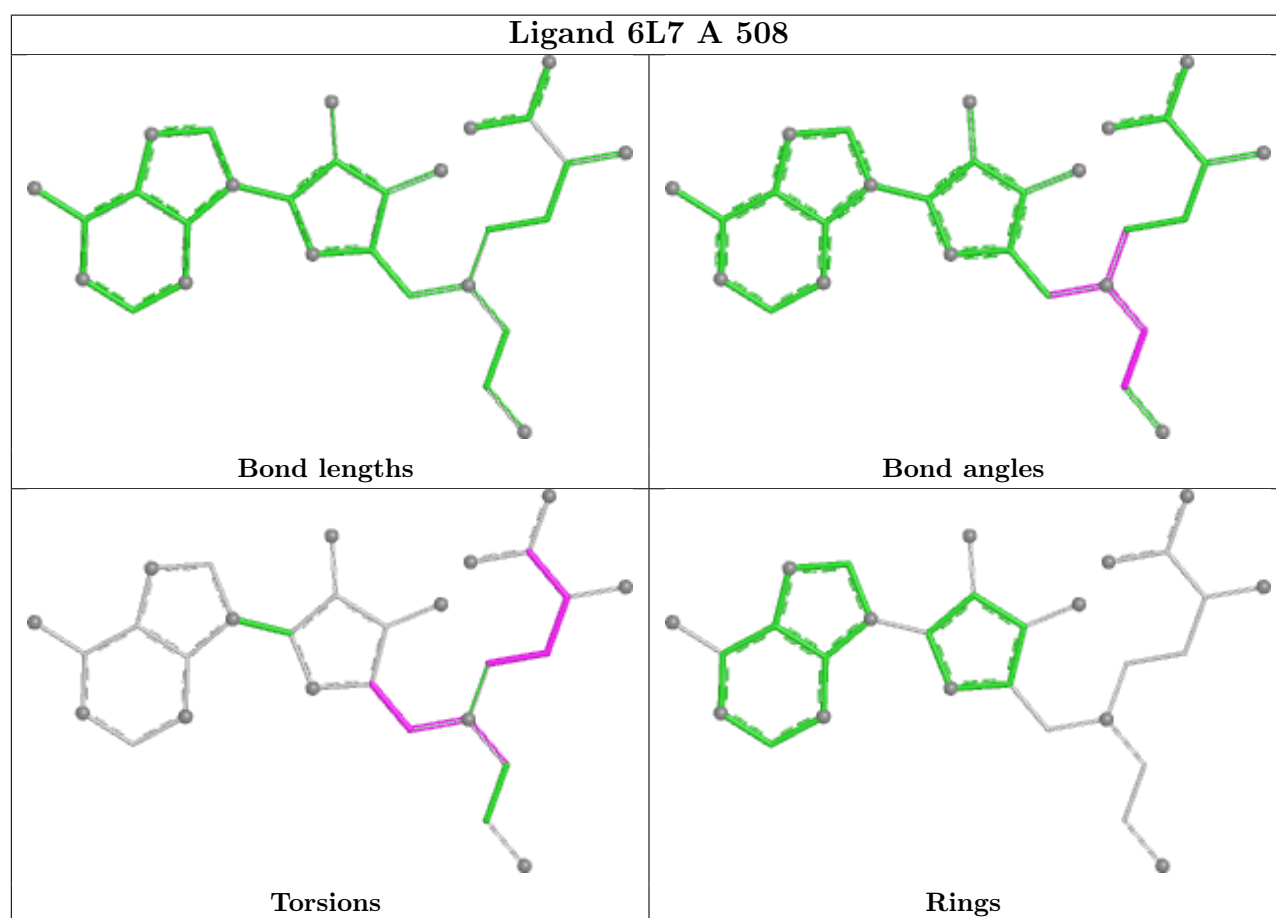
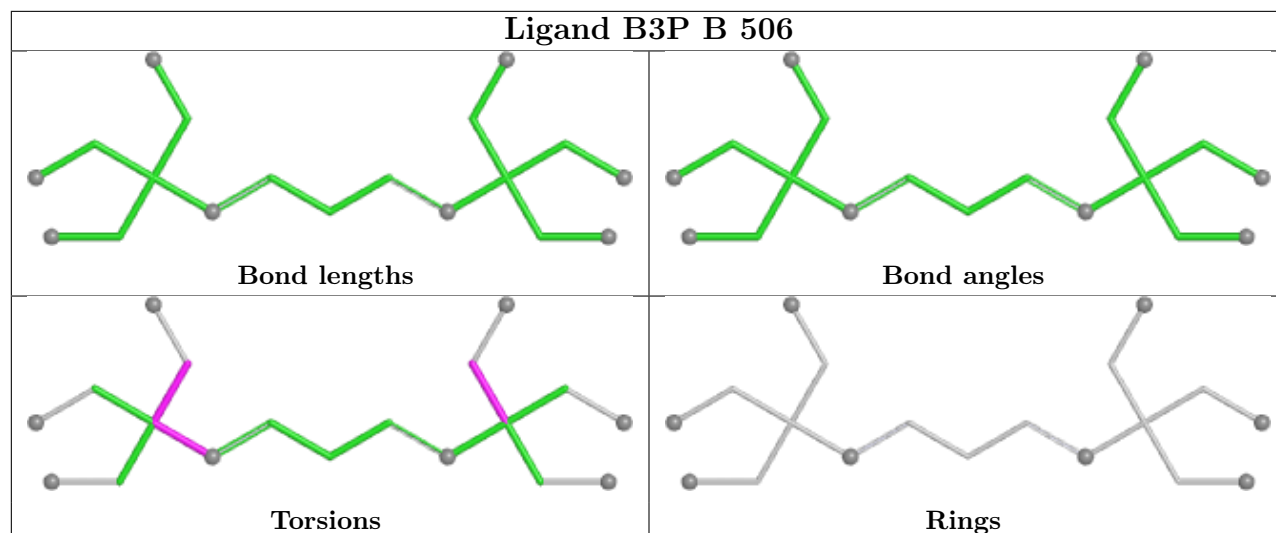

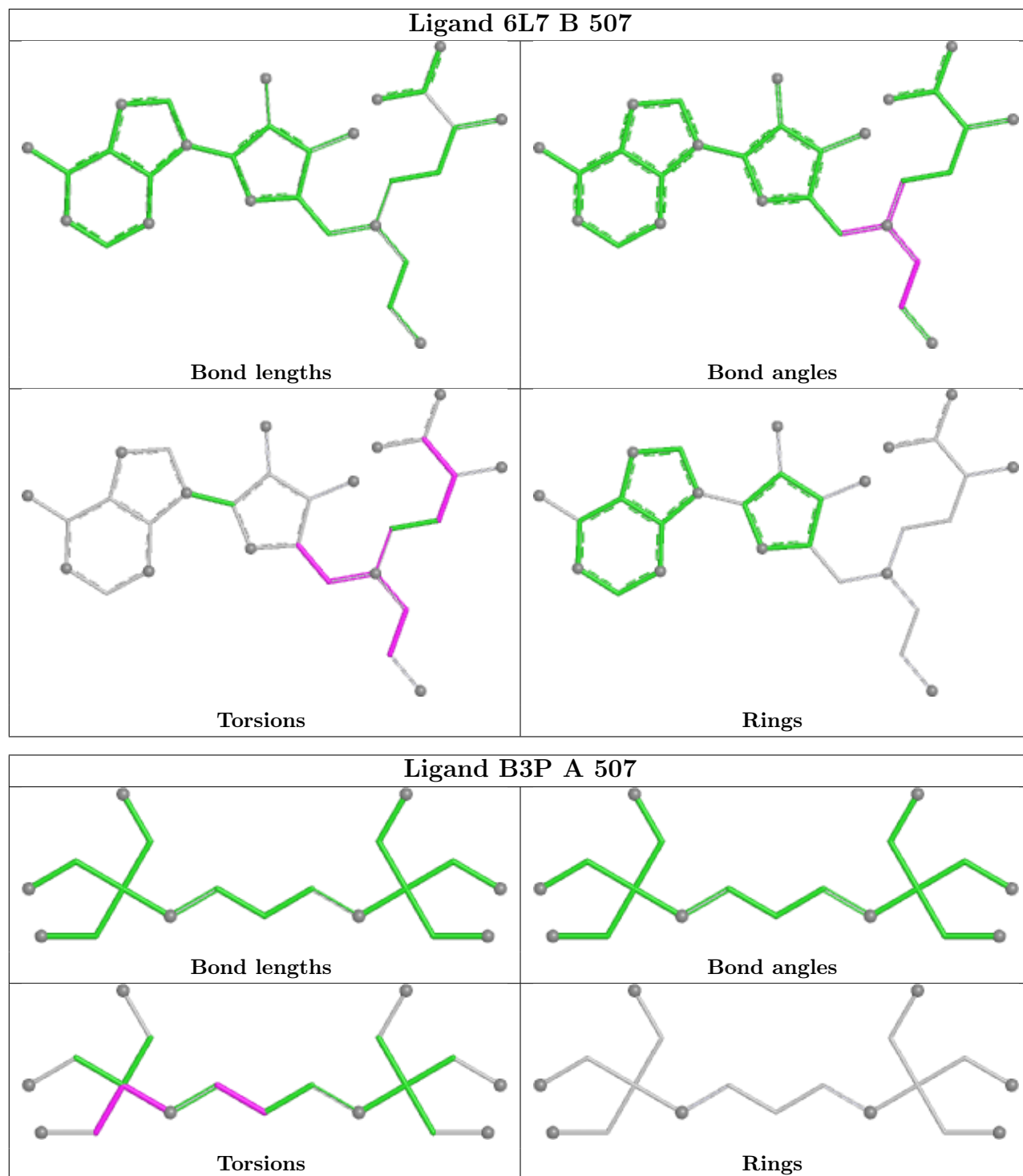

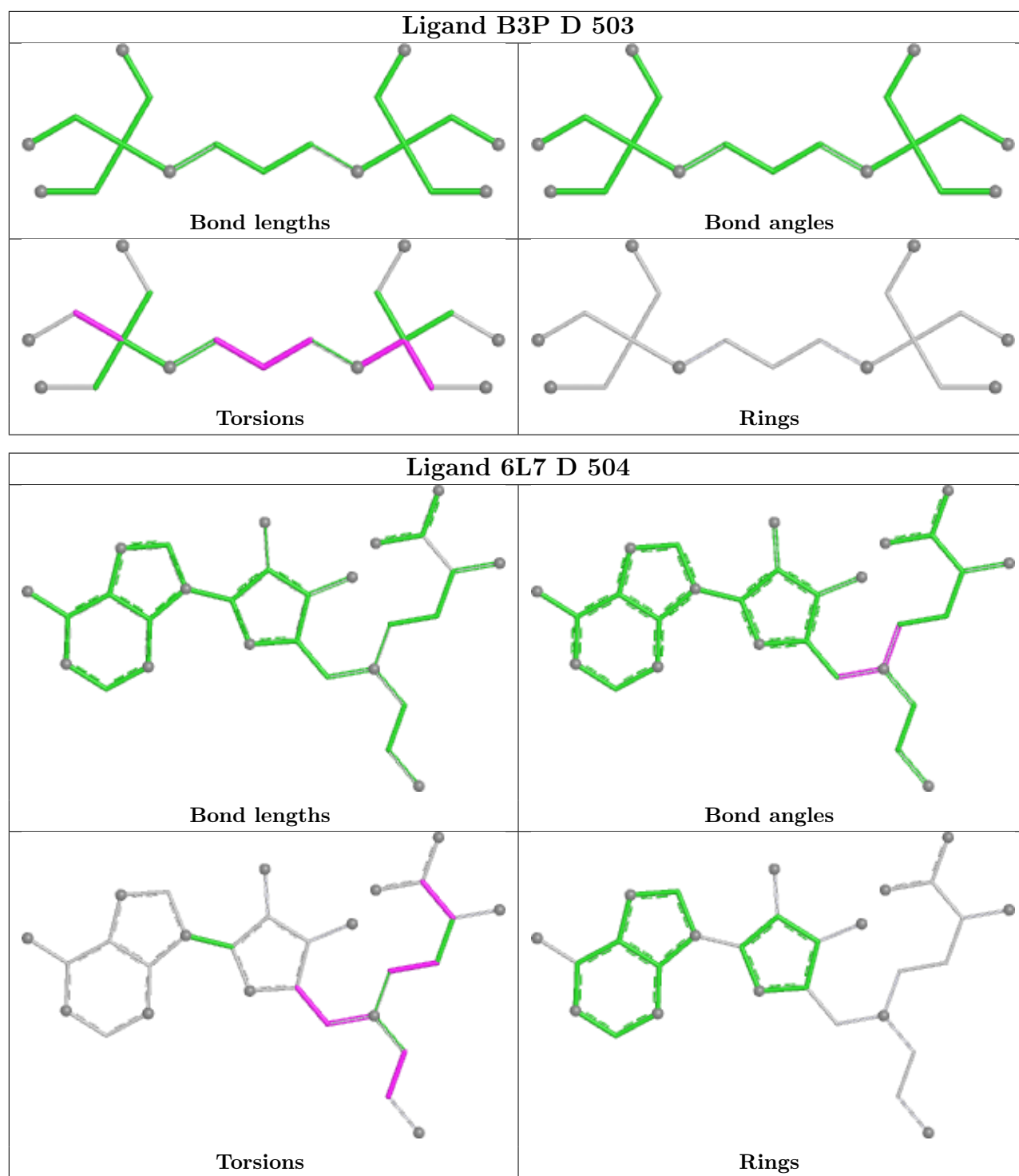

## 5.7 Other polymers [\(i\)](#)

There are no such residues in this entry.

## 5.8 Polymer linkage issues

There are no chain breaks in this entry.

## 6 Fit of model and data [i](#)

### 6.1 Protein, DNA and RNA chains [i](#)

In the following table, the column labelled ‘#RSRZ > 2’ contains the number (and percentage) of RSRZ outliers, followed by percent RSRZ outliers for the chain as percentile scores relative to all X-ray entries and entries of similar resolution. The OWAB column contains the minimum, median, 95<sup>th</sup> percentile and maximum values of the occupancy-weighted average B-factor per residue. The column labelled ‘Q < 0.9’ lists the number of (and percentage) of residues with an average occupancy less than 0.9.

Mol	Chain	Analysed	<RSRZ>	#RSRZ>2	OWAB(Å <sup>2</sup> )	Q<0.9
1	A	350/371 (94%)	-0.34	2 (0%) 85 86	16, 37, 62, 89	1 (0%)
1	B	333/371 (89%)	-0.25	5 (1%) 72 73	20, 39, 67, 88	2 (0%)
1	C	348/371 (93%)	0.26	12 (3%) 48 48	22, 58, 89, 115	1 (0%)
1	D	333/371 (89%)	-0.06	7 (2%) 63 64	20, 50, 76, 104	2 (0%)
All	All	1364/1484 (91%)	-0.10	26 (1%) 66 67	16, 46, 79, 115	6 (0%)

The worst 5 of 26 RSRZ outliers are listed below:

Mol	Chain	Res	Type	RSRZ
1	D	478	THR	3.6
1	D	477	TYR	3.5
1	B	477[A]	TYR	3.2
1	C	490	TYR	3.2
1	C	270	LEU	3.1

### 6.2 Non-standard residues in protein, DNA, RNA chains [i](#)

There are no non-standard protein/DNA/RNA residues in this entry.

### 6.3 Carbohydrates [i](#)

There are no oligosaccharides in this entry.

### 6.4 Ligands [i](#)

In the following table, the Atoms column lists the number of modelled atoms in the group and the number defined in the chemical component dictionary. The B-factors column lists the minimum, median, 95<sup>th</sup> percentile and maximum values of B factors of atoms in the group. The column labelled ‘Q < 0.9’ lists the number of atoms with occupancy less than 0.9.

Mol	Type	Chain	Res	Atoms	RSCC	RSR	B-factors( $\text{\AA}^2$ )	Q<0.9
2	EDO	C	502	4/4	0.61	0.15	65,78,80,80	0
2	EDO	C	504	4/4	0.64	0.18	59,60,63,65	0
4	DXE	C	505	6/6	0.64	0.14	59,71,78,78	0
2	EDO	A	502	4/4	0.73	0.15	52,57,64,67	0
2	EDO	B	503	4/4	0.74	0.14	54,54,56,57	0
5	M2M	A	506	9/9	0.74	0.14	41,52,62,62	0
2	EDO	B	505	4/4	0.75	0.14	57,58,58,61	0
2	EDO	D	501	4/4	0.75	0.12	60,61,61,62	0
2	EDO	B	504	4/4	0.76	0.14	59,60,62,62	0
2	EDO	C	503	4/4	0.76	0.15	57,58,60,62	0
2	EDO	A	501	4/4	0.76	0.15	54,65,70,70	0
2	EDO	A	503	4/4	0.77	0.11	57,59,62,65	0
2	EDO	B	501	4/4	0.78	0.12	53,64,66,69	0
4	DXE	A	505	6/6	0.79	0.13	43,53,64,64	0
3	PEG	A	504	7/7	0.81	0.13	52,62,68,68	0
2	EDO	B	502	4/4	0.82	0.10	57,69,71,71	0
6	B3P	A	507	19/19	0.86	0.11	38,53,77,79	0
2	EDO	C	501	4/4	0.87	0.08	54,65,66,67	0
3	PEG	D	502	7/7	0.88	0.09	53,64,70,71	0
6	B3P	D	503	19/19	0.89	0.10	42,57,73,73	0
7	6L7	C	506	29/29	0.89	0.10	45,62,77,78	0
7	6L7	D	504	29/29	0.91	0.09	30,45,66,71	0
6	B3P	B	506	19/19	0.92	0.08	30,47,58,61	0
7	6L7	B	507	29/29	0.93	0.07	24,37,56,58	0
7	6L7	A	508	29/29	0.94	0.08	25,39,62,70	0

The following is a graphical depiction of the model fit to experimental electron density of all instances of the Ligand of Interest. In addition, ligands with molecular weight > 250 and outliers as shown on the geometry validation Tables will also be included. Each fit is shown from different orientation to approximate a three-dimensional view.

**Electron density around B3P A 507:**

$2mF_o-DF_c$  (at 0.7 rmsd) in gray  
 $mF_o-DF_c$  (at 3 rmsd) in purple (negative)  
and green (positive)

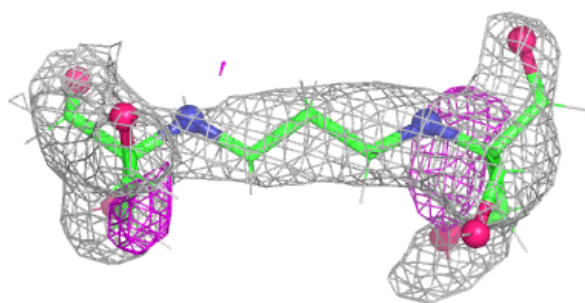
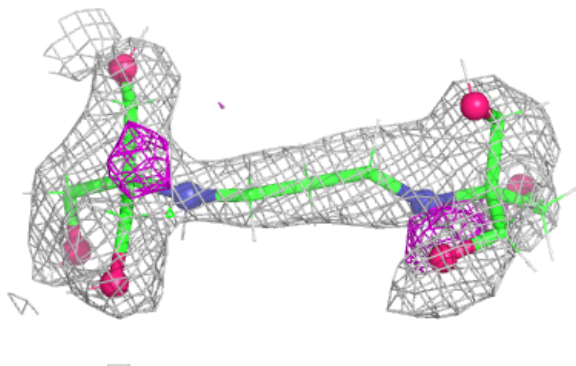
**Electron density around B3P D 503:**

$2mF_o-DF_c$  (at 0.7 rmsd) in gray  
 $mF_o-DF_c$  (at 3 rmsd) in purple (negative)  
and green (positive)

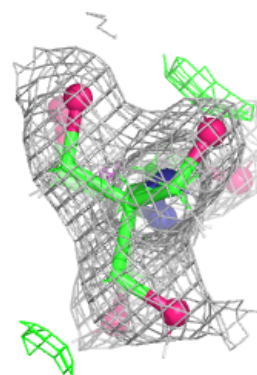
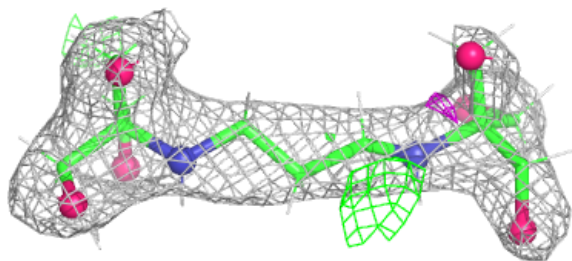
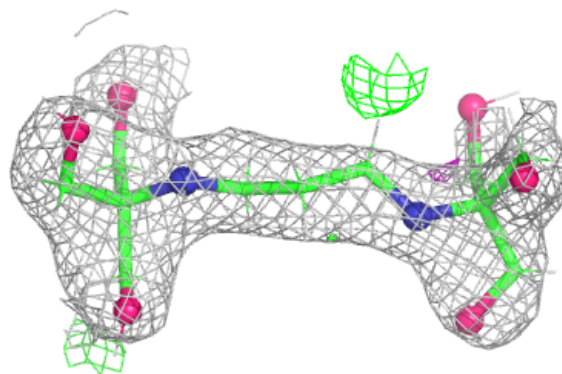

**Electron density around 6L7 C 506:**

$2mF_o-DF_c$  (at 0.7 rmsd) in gray  
 $mF_o-DF_c$  (at 3 rmsd) in purple (negative)  
and green (positive)

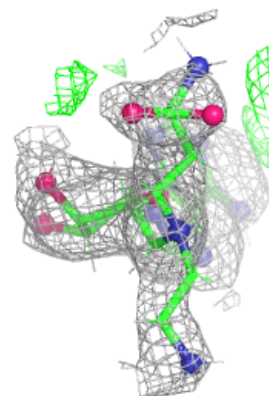
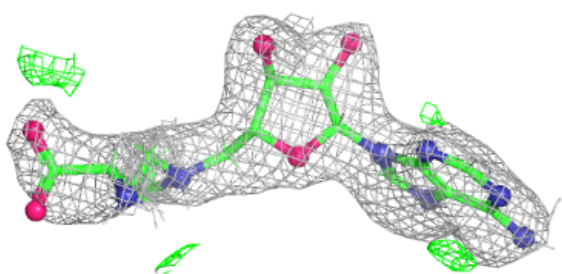
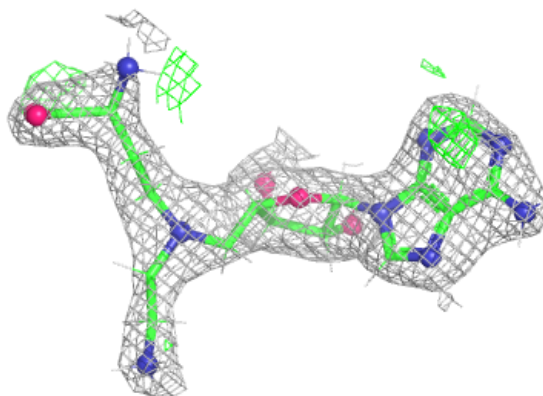
**Electron density around 6L7 D 504:**

$2mF_o-DF_c$  (at 0.7 rmsd) in gray  
 $mF_o-DF_c$  (at 3 rmsd) in purple (negative)  
and green (positive)

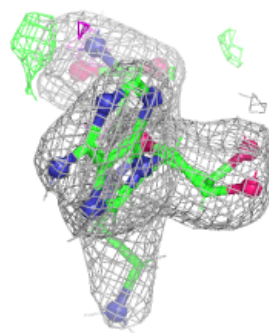
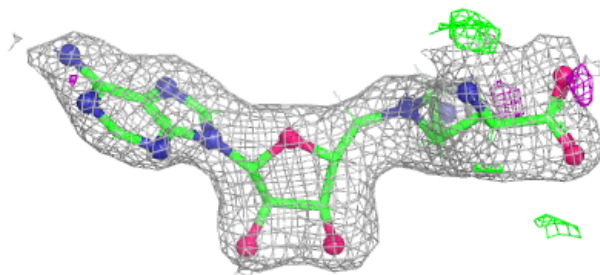
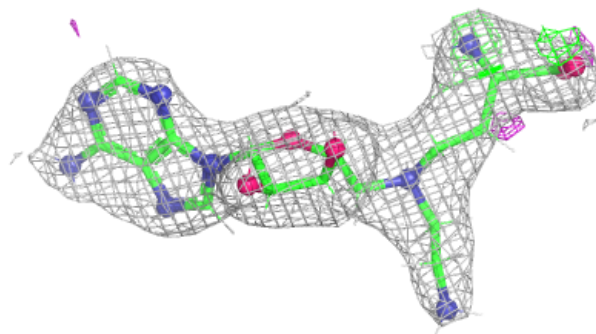

**Electron density around B3P B 506:**

$2mF_o-DF_c$  (at 0.7 rmsd) in gray  
 $mF_o-DF_c$  (at 3 rmsd) in purple (negative)  
and green (positive)

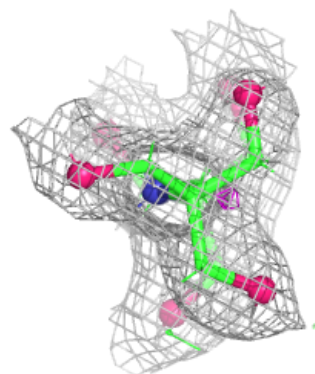
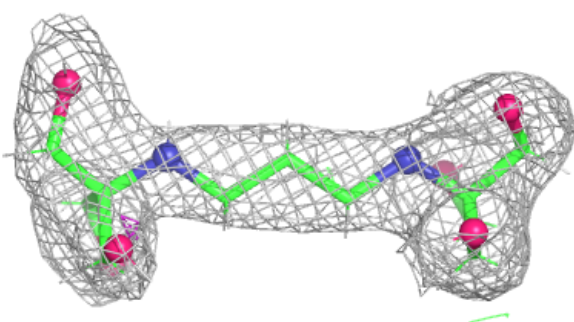
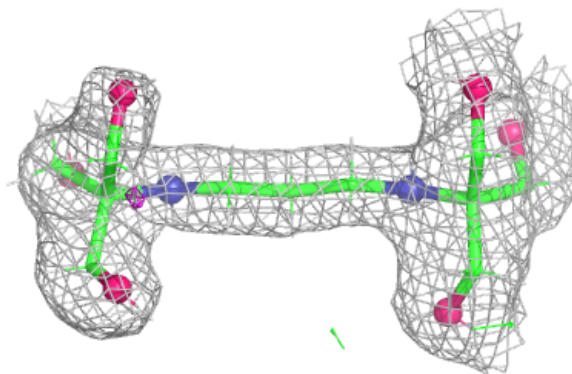
**Electron density around 6L7 B 507:**

$2mF_o-DF_c$  (at 0.7 rmsd) in gray  
 $mF_o-DF_c$  (at 3 rmsd) in purple (negative)  
and green (positive)

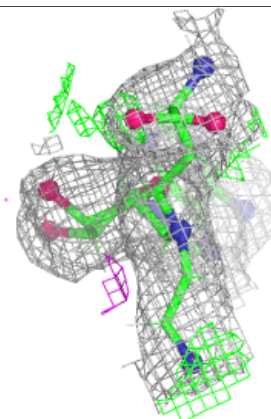
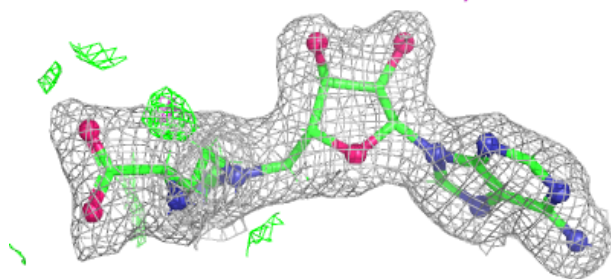
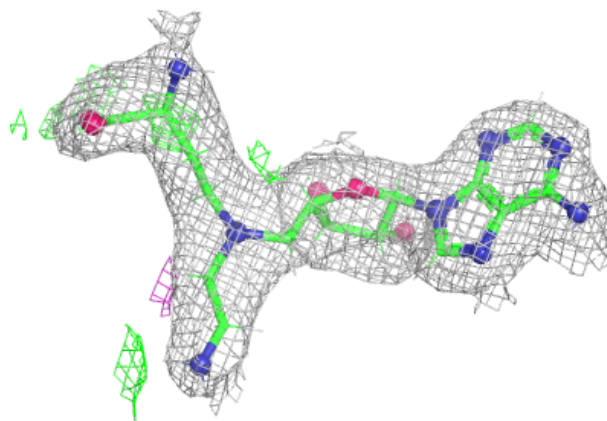

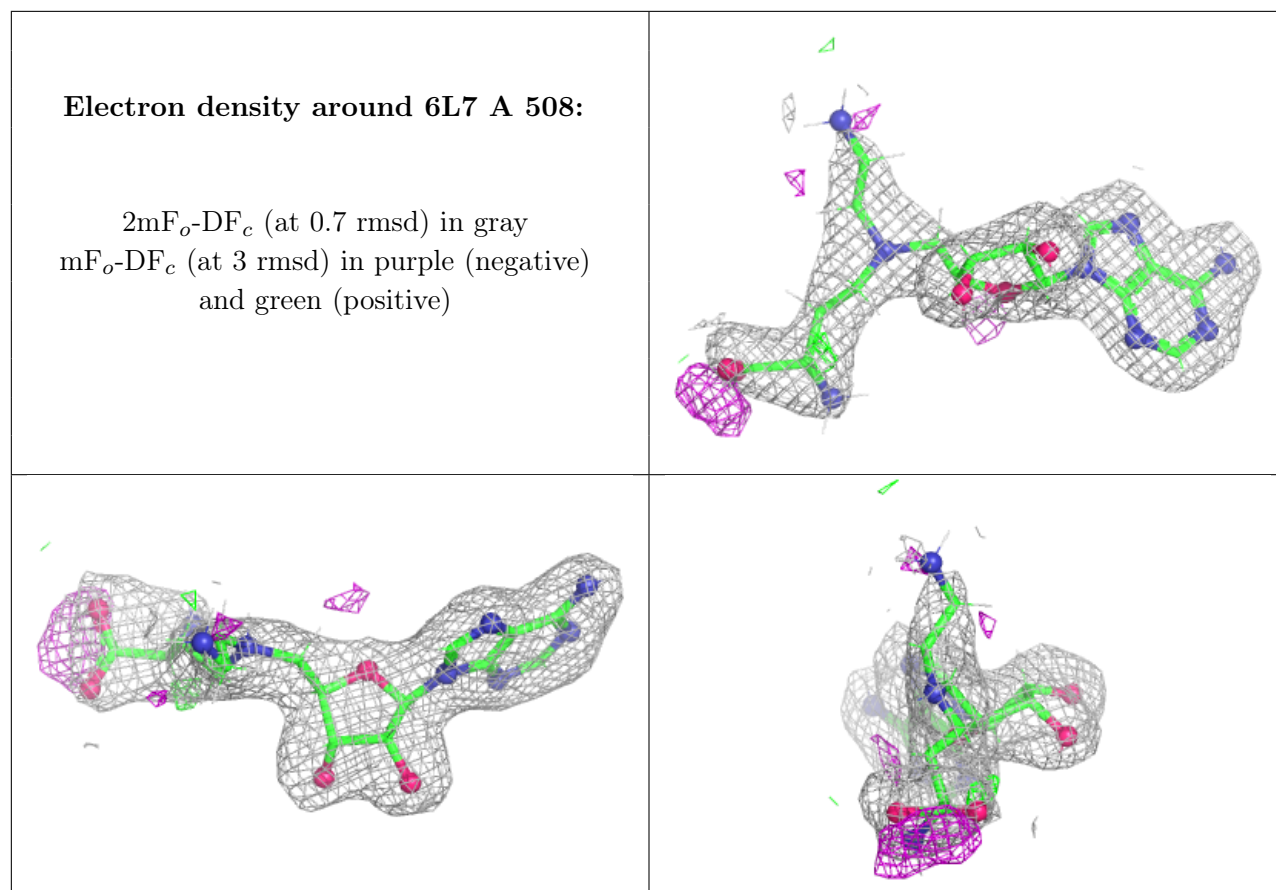

## 6.5 Other polymers [i](#)

There are no such residues in this entry.