



# wwPDB X-ray Structure Validation Summary Report ⓘ

Mar 9, 2026 – 01:25 AM UTC

PDB ID : 5S8B / pdb\_00005s8b  
Title : XChem group deposition – Crystal Structure of human ACVR1 in complex with FM010960a  
Authors : Williams, E.P.; Adamson, R.J.; Smil, D.; Krojer, T.; Burgess-Brown, N.; von Delft, F.; Bountra, C.; Bullock, A.N.  
Deposited on : 2020-12-11  
Resolution : 1.64 Å(reported)

This is a wwPDB X-ray Structure Validation Summary Report for a publicly released PDB entry.

We welcome your comments at [validation@mail.wwpdb.org](mailto:validation@mail.wwpdb.org)

A user guide is available at

<https://www.wwpdb.org/validation/2017/XrayValidationReportHelp>

with specific help available everywhere you see the ⓘ symbol.

The types of validation reports are described at

<http://www.wwpdb.org/validation/2017/FAQs#types>.

---

The following versions of software and data (see [references ⓘ](#)) were used in the production of this report:

MolProbity : 4-5-2 with Phenix2.0  
Mogul : 2022.3.0, CSD as543be (2022)  
Xtrriage (Phenix) : 2.0  
EDS : 3.0  
Buster-report : wwPDB partial adaption of 1.1.7 (2018)  
Percentile statistics : 20250101.v01 (using entries in the PDB archive January 1st 2025)  
CCP4 : 9.0.010 (Gargrove)  
Density-Fitness : 1.0.12  
Ideal geometry (proteins) : Engh & Huber (2001)  
Ideal geometry (DNA, RNA) : Parkinson et al. (1996)  
Validation Pipeline (wwPDB-VP) : 2.49

# 1 Overall quality at a glance

The following experimental techniques were used to determine the structure:

*X-RAY DIFFRACTION*

The reported resolution of this entry is 1.64 Å.

Percentile scores (ranging between 0-100) for global validation metrics of the entry are shown in the following graphic. The table shows the number of entries on which the scores are based.

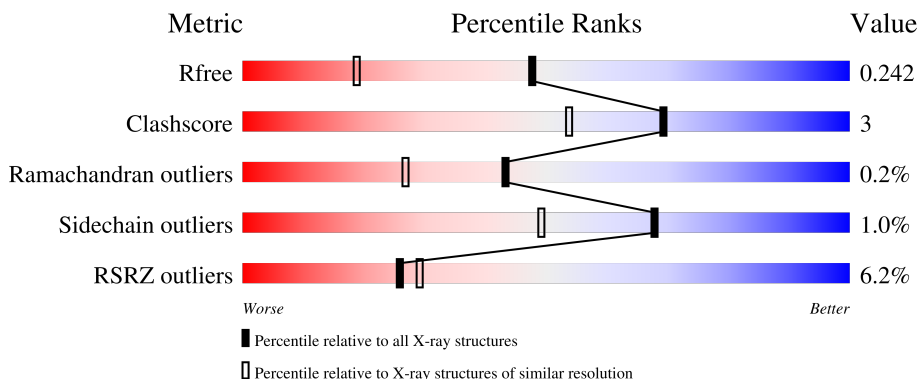

Metric	Whole archive (#Entries)	Similar resolution (#Entries, resolution range(Å))
$R_{free}$	180053	1141 (1.64-1.64)
Clashscore	190562	1171 (1.64-1.64)
Ramachandran outliers	187476	1151 (1.64-1.64)
Sidechain outliers	187428	1150 (1.64-1.64)
RSRZ outliers	180081	1141 (1.64-1.64)

The table below summarises the geometric issues observed across the polymeric chains and their fit to the electron density. The red, orange, yellow and green segments of the lower bar indicate the fraction of residues that contain outliers for  $\geq 3$ , 2, 1 and 0 types of geometric quality criteria respectively. A grey segment represents the fraction of residues that are not modelled. The numeric value for each fraction is indicated below the corresponding segment, with a dot representing fractions  $\leq 5\%$ . The upper red bar (where present) indicates the fraction of residues that have poor fit to the electron density. The numeric value is given above the bar.

Mol	Chain	Length	Quality of chain
1	A	301	 7% 85% 9% 6%
1	B	301	 5% 89% 8% .

## 2 Entry composition [i](#)

There are 7 unique types of molecules in this entry. The entry contains 5694 atoms, of which 0 are hydrogens and 0 are deuteriums.

In the tables below, the ZeroOcc column contains the number of atoms modelled with zero occupancy, the AltConf column contains the number of residues with at least one atom in alternate conformation and the Trace column contains the number of residues modelled with at most 2 atoms.

- Molecule 1 is a protein called Activin receptor type-1.

Mol	Chain	Residues	Atoms					ZeroOcc	AltConf	Trace
			Total	C	N	O	S			
1	A	284	2342	1498	401	428	15	0	13	0
1	B	292	2366	1508	408	434	16	0	7	0

There are 6 discrepancies between the modelled and reference sequences:

Chain	Residue	Modelled	Actual	Comment	Reference
A	199	SER	-	expression tag	UNP Q04771
A	200	MET	-	expression tag	UNP Q04771
A	207	ASP	GLN	engineered mutation	UNP Q04771
B	199	SER	-	expression tag	UNP Q04771
B	200	MET	-	expression tag	UNP Q04771
B	207	ASP	GLN	engineered mutation	UNP Q04771

- Molecule 2 is 4-methyl-3-[4-(1-methylpiperidin-4-yl)phenyl]-5-(3,4,5-trimethoxyphenyl)pyridine (CCD ID: LU8) (formula: C<sub>27</sub>H<sub>32</sub>N<sub>2</sub>O<sub>3</sub>).

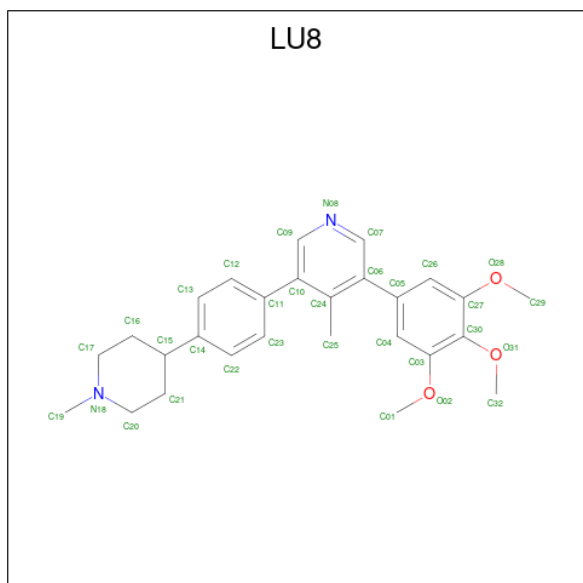

Mol	Chain	Residues	Atoms				ZeroOcc	AltConf
2	A	1	Total	C	N	O	0	1
			64	54	4	6		
2	A	1	Total	C	N	O	0	0
			32	27	2	3		
2	A	1	Total	C	N	O	0	0
			32	27	2	3		
2	B	1	Total	C	N	O	0	0
			32	27	2	3		

- Molecule 3 is 1,2-ETHANEDIOL (CCD ID: EDO) (formula: C<sub>2</sub>H<sub>6</sub>O<sub>2</sub>).

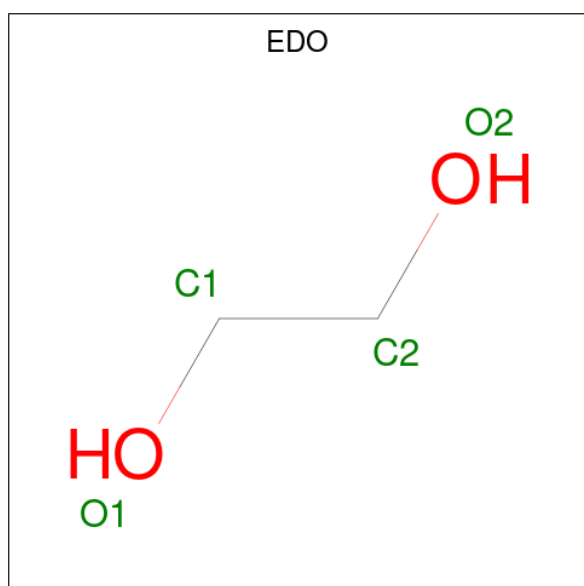

Mol	Chain	Residues	Atoms			ZeroOcc	AltConf
3	A	1	Total	C	O	0	0
			4	2	2		
3	A	1	Total	C	O	0	0
			4	2	2		
3	A	1	Total	C	O	0	0
			4	2	2		
3	A	1	Total	C	O	0	0
			4	2	2		
3	A	1	Total	C	O	0	0
			4	2	2		
3	A	1	Total	C	O	0	0
			4	2	2		
3	A	1	Total	C	O	0	0
			4	2	2		

*Continued on next page...*

Continued from previous page...

Mol	Chain	Residues	Atoms			ZeroOcc	AltConf
3	B	1	Total	C	O	0	0
			4	2	2		
3	B	1	Total	C	O	0	0
			4	2	2		
3	B	1	Total	C	O	0	0
			4	2	2		
3	B	1	Total	C	O	0	0
			4	2	2		

- Molecule 4 is DIMETHYL SULFOXIDE (CCD ID: DMS) (formula: C<sub>2</sub>H<sub>6</sub>OS).

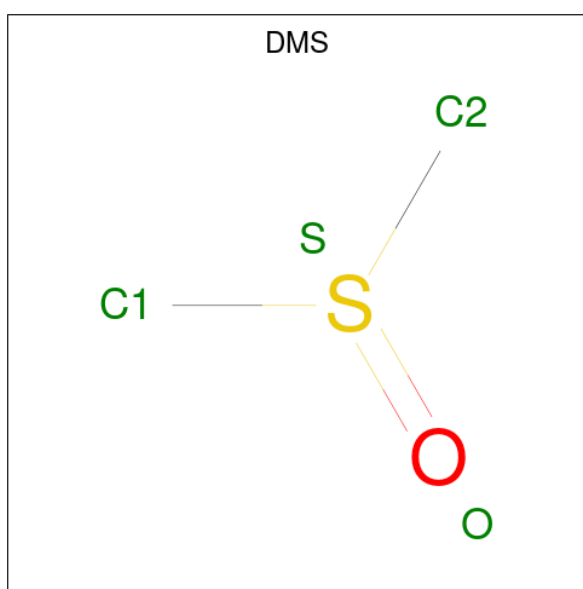

Mol	Chain	Residues	Atoms				ZeroOcc	AltConf
4	A	1	Total	C	O	S	0	0
			4	2	1	1		
4	B	1	Total	C	O	S	0	0
			4	2	1	1		

- Molecule 5 is 1lambda 6 -thietane-1,1-dione (CCD ID: XFV) (formula: C<sub>3</sub>H<sub>6</sub>O<sub>2</sub>S).

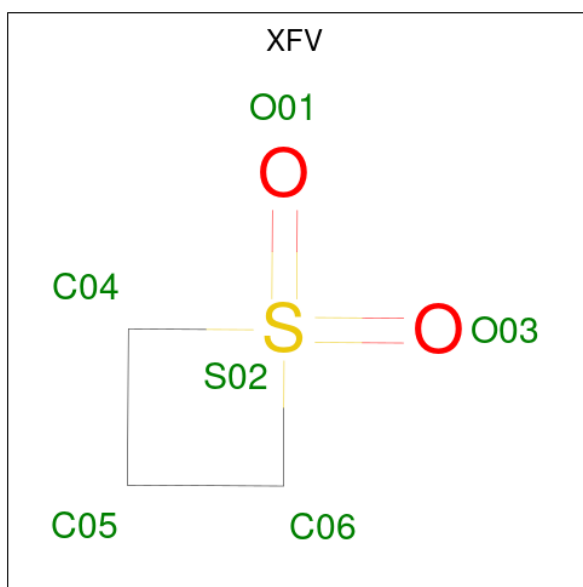

Mol	Chain	Residues	Atoms				ZeroOcc	AltConf
			Total	C	O	S		
5	A	1	6	3	2	1	0	0
5	A	1	6	3	2	1	0	0
5	A	1	6	3	2	1	0	0
5	A	1	6	3	2	1	0	0
5	B	1	6	3	2	1	0	0
5	B	1	6	3	2	1	0	0
5	B	1	6	3	2	1	0	0

- Molecule 6 is SULFATE ION (CCD ID: SO4) (formula: O<sub>4</sub>S).



Mol	Chain	Residues	Atoms			ZeroOcc	AltConf
6	A	1	Total	O	S	0	0
			5	4	1		
6	A	1	Total	O	S	0	0
			5	4	1		
6	A	1	Total	O	S	0	0
			5	4	1		
6	B	1	Total	O	S	0	0
			5	4	1		
6	B	1	Total	O	S	0	0
			5	4	1		
6	B	1	Total	O	S	0	0
			5	4	1		

- Molecule 7 is water.

Mol	Chain	Residues	Atoms		ZeroOcc	AltConf
7	A	329	Total	O	0	0
			329	329		
7	B	369	Total	O	0	0
			369	369		

### 3 Residue-property plots [i](#)

These plots are drawn for all protein, RNA, DNA and oligosaccharide chains in the entry. The first graphic for a chain summarises the proportions of the various outlier classes displayed in the second graphic. The second graphic shows the sequence view annotated by issues in geometry and electron density. Residues are color-coded according to the number of geometric quality criteria for which they contain at least one outlier: green = 0, yellow = 1, orange = 2 and red = 3 or more. A red dot above a residue indicates a poor fit to the electron density ( $RSRZ > 2$ ). Stretches of 2 or more consecutive residues without any outlier are shown as a green connector. Residues present in the sample, but not in the model, are shown in grey.

- Molecule 1: Activin receptor type-1

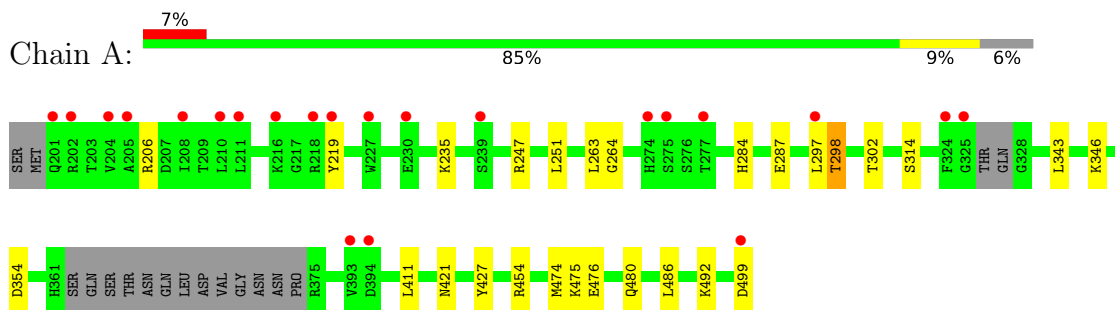

- Molecule 1: Activin receptor type-1

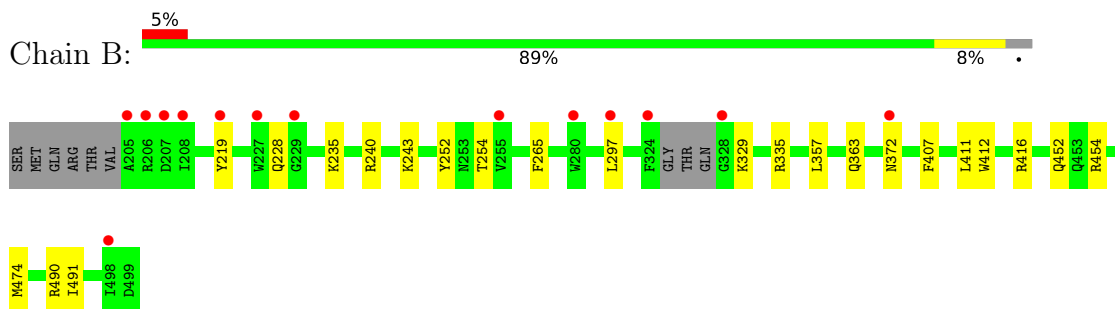

## 4 Data and refinement statistics

Property	Value	Source
Space group	C 1 2 1	Depositor
Cell constants a, b, c, $\alpha$ , $\beta$ , $\gamma$	127.22Å 84.80Å 88.17Å 90.00° 130.98° 90.00°	Depositor
Resolution (Å)	66.56 – 1.64 66.56 – 1.64	Depositor EDS
% Data completeness (in resolution range)	99.7 (66.56-1.64) 99.7 (66.56-1.64)	Depositor EDS
$R_{merge}$	0.18	Depositor
$R_{sym}$	(Not available)	Depositor
$\langle I/\sigma(I) \rangle$ <sup>1</sup>	1.08 (at 1.64Å)	Xtrriage
Refinement program	REFMAC 5.8.0267	Depositor
R, $R_{free}$	0.198 , 0.233 0.209 , 0.242	Depositor DCC
$R_{free}$ test set	4193 reflections (4.85%)	wwPDB-VP
Wilson B-factor (Å <sup>2</sup> )	20.5	Xtrriage
Anisotropy	0.208	Xtrriage
Bulk solvent $k_{sol}$ (e/Å <sup>3</sup> ), $B_{sol}$ (Å <sup>2</sup> )	0.36 , 46.0	EDS
L-test for twinning <sup>2</sup>	$\langle  L  \rangle = 0.49$ , $\langle L^2 \rangle = 0.33$	Xtrriage
Estimated twinning fraction	0.015 for -h+k-l,-l,-k 0.000 for -h-k-l,l,k 0.022 for -h-2*l,-k,l	Xtrriage
$F_o, F_c$ correlation	0.96	EDS
Total number of atoms	5694	wwPDB-VP
Average B, all atoms (Å <sup>2</sup> )	27.0	wwPDB-VP

Xtrriage's analysis on translational NCS is as follows: *The largest off-origin peak in the Patterson function is 4.89% of the height of the origin peak. No significant pseudotranslation is detected.*

<sup>1</sup>Intensities estimated from amplitudes.

<sup>2</sup>Theoretical values of  $\langle |L| \rangle$ ,  $\langle L^2 \rangle$  for acentric reflections are 0.5, 0.333 respectively for untwinned datasets, and 0.375, 0.2 for perfectly twinned datasets.

## 5 Model quality [i](#)

### 5.1 Standard geometry [i](#)

Bond lengths and bond angles in the following residue types are not validated in this section: SO4, EDO, DMS, XFV, LU8

The Z score for a bond length (or angle) is the number of standard deviations the observed value is removed from the expected value. A bond length (or angle) with  $|Z| > 5$  is considered an outlier worth inspection. RMSZ is the root-mean-square of all Z scores of the bond lengths (or angles).

Mol	Chain	Bond lengths		Bond angles	
		RMSZ	# Z  >5	RMSZ	# Z  >5
1	A	1.01	0/2404	1.23	1/3259 (0.0%)
1	B	1.03	0/2425	1.24	0/3291
All	All	1.02	0/4829	1.23	1/6550 (0.0%)

There are no bond length outliers.

All (1) bond angle outliers are listed below:

Mol	Chain	Res	Type	Atoms	Z	Observed(°)	Ideal(°)
1	A	298	THR	CB-CA-C	-5.24	99.18	110.45

There are no chirality outliers.

There are no planarity outliers.

### 5.2 Too-close contacts [i](#)

In the following table, the Non-H and H(model) columns list the number of non-hydrogen atoms and hydrogen atoms in the chain respectively. The H(added) column lists the number of hydrogen atoms added and optimized by MolProbity. The Clashes column lists the number of clashes within the asymmetric unit, whereas Symm-Clashes lists symmetry-related clashes.

Mol	Chain	Non-H	H(model)	H(added)	Clashes	Symm-Clashes
1	A	2342	0	2306	15	0
1	B	2366	0	2329	15	0
2	A	128	0	0	2	0
2	B	32	0	0	1	0
3	A	32	0	48	0	0
3	B	16	0	24	1	0
4	A	4	0	6	0	0
4	B	4	0	6	1	0

*Continued on next page...*

Continued from previous page...

Mol	Chain	Non-H	H(model)	H(added)	Clashes	Symm-Clashes
5	A	24	0	0	0	0
5	B	18	0	0	2	0
6	A	15	0	0	0	0
6	B	15	0	0	0	0
7	A	329	0	0	2	0
7	B	369	0	0	6	0
All	All	5694	0	4719	34	0

The all-atom clashscore is defined as the number of clashes found per 1000 atoms (including hydrogen atoms). The all-atom clashscore for this structure is 3.

The worst 5 of 34 close contacts within the same asymmetric unit are listed below, sorted by their clash magnitude.

Atom-1	Atom-2	Interatomic distance (Å)	Clash overlap (Å)
1:A:247:ARG:CD	7:A:705:HOH:O	2.35	0.73
1:A:411:LEU:HG	1:A:474:MET:HE2	1.72	0.71
2:A:501[B]:LU8:C25	2:A:501[B]:LU8:C12	2.69	0.71
1:B:490:ARG:HH22	4:B:504:DMS:H12	1.58	0.68
1:B:252:TYR:CD1	1:B:265:PHE:HB2	2.30	0.67

There are no symmetry-related clashes.

## 5.3 Torsion angles [i](#)

### 5.3.1 Protein backbone [i](#)

In the following table, the Percentiles column shows the percent Ramachandran outliers of the chain as a percentile score with respect to all X-ray entries followed by that with respect to entries of similar resolution.

The Analysed column shows the number of residues for which the backbone conformation was analysed, and the total number of residues.

Mol	Chain	Analysed	Favoured	Allowed	Outliers	Percentiles	
1	A	291/301 (97%)	284 (98%)	6 (2%)	1 (0%)	36	20
1	B	295/301 (98%)	291 (99%)	4 (1%)	0	100	100
All	All	586/602 (97%)	575 (98%)	10 (2%)	1 (0%)	43	27

All (1) Ramachandran outliers are listed below:

Mol	Chain	Res	Type
1	A	354	ASP

### 5.3.2 Protein sidechains [i](#)

In the following table, the Percentiles column shows the percent sidechain outliers of the chain as a percentile score with respect to all X-ray entries followed by that with respect to entries of similar resolution.

The Analysed column shows the number of residues for which the sidechain conformation was analysed, and the total number of residues.

Mol	Chain	Analysed	Rotameric	Outliers	Percentiles	
1	A	254/270 (94%)	252 (99%)	2 (1%)	73	58
1	B	260/270 (96%)	257 (99%)	3 (1%)	63	41
All	All	514/540 (95%)	509 (99%)	5 (1%)	68	49

All (5) residues with a non-rotameric sidechain are listed below:

Mol	Chain	Res	Type
1	A	297	LEU
1	A	298	THR
1	B	240	ARG
1	B	297	LEU
1	B	452	GLN

Sometimes sidechains can be flipped to improve hydrogen bonding and reduce clashes. All (2) such sidechains are listed below:

Mol	Chain	Res	Type
1	B	284	HIS
1	B	452	GLN

### 5.3.3 RNA [i](#)

There are no RNA molecules in this entry.

## 5.4 Non-standard residues in protein, DNA, RNA chains [i](#)

There are no non-standard protein/DNA/RNA residues in this entry.

## 5.5 Carbohydrates [i](#)

There are no oligosaccharides in this entry.

## 5.6 Ligand geometry [i](#)

32 ligands are modelled in this entry.

In the following table, the Counts columns list the number of bonds (or angles) for which Mogul statistics could be retrieved, the number of bonds (or angles) that are observed in the model and the number of bonds (or angles) that are defined in the Chemical Component Dictionary. The Link column lists molecule types, if any, to which the group is linked. The Z score for a bond length (or angle) is the number of standard deviations the observed value is removed from the expected value. A bond length (or angle) with  $|Z| > 2$  is considered an outlier worth inspection. RMSZ is the root-mean-square of all Z scores of the bond lengths (or angles).

Mol	Type	Chain	Res	Link	Bond lengths			Bond angles		
					Counts	RMSZ	# Z  > 2	Counts	RMSZ	# Z  > 2
3	EDO	A	516	-	3,3,3	0.11	0	2,2,2	0.12	0
5	XFV	A	511	-	4,6,6	5.43	2 (50%)	1,9,9	0.72	0
5	XFV	A	510	-	4,6,6	5.12	2 (50%)	1,9,9	0.81	0
6	SO4	B	508	-	4,4,4	0.32	0	6,6,6	0.11	0
2	LU8	A	507	-	35,35,35	0.71	0	47,49,49	2.08	16 (34%)
3	EDO	B	510	-	3,3,3	0.36	0	2,2,2	0.49	0
4	DMS	B	504	-	3,3,3	0.34	0	3,3,3	0.09	0
5	XFV	B	506	-	4,6,6	5.20	2 (50%)	1,9,9	1.82	0
6	SO4	A	515	-	4,4,4	0.42	0	6,6,6	0.15	0
3	EDO	A	504	-	3,3,3	0.12	0	2,2,2	0.14	0
6	SO4	B	502	-	4,4,4	0.44	0	6,6,6	0.34	0
3	EDO	A	517	-	3,3,3	0.18	0	2,2,2	0.21	0
2	LU8	A	508	-	35,35,35	0.63	0	47,49,49	1.65	10 (21%)
5	XFV	A	512	-	4,6,6	5.27	2 (50%)	1,9,9	1.28	0
3	EDO	B	511	-	3,3,3	0.19	0	2,2,2	0.18	0
3	EDO	A	519	-	3,3,3	0.31	0	2,2,2	0.48	0
3	EDO	A	503	-	3,3,3	0.69	0	2,2,2	0.88	0
2	LU8	A	501[A]	-	35,35,35	0.80	0	47,49,49	1.67	9 (19%)
2	LU8	A	501[B]	-	35,35,35	0.75	0	47,49,49	1.51	7 (14%)
2	LU8	B	501	-	35,35,35	0.81	0	47,49,49	1.71	14 (29%)
3	EDO	A	502	-	3,3,3	0.51	0	2,2,2	0.35	0
6	SO4	A	513	-	4,4,4	0.28	0	6,6,6	0.19	0
5	XFV	B	505	-	4,6,6	5.26	2 (50%)	1,9,9	1.14	0
4	DMS	A	506	-	3,3,3	0.26	0	3,3,3	0.08	0
3	EDO	A	505	-	3,3,3	0.45	0	2,2,2	0.80	0

Mol	Type	Chain	Res	Link	Bond lengths			Bond angles		
					Counts	RMSZ	# Z  > 2	Counts	RMSZ	# Z  > 2
3	EDO	B	512	-	3,3,3	0.13	0	2,2,2	0.19	0
6	SO4	B	509	-	4,4,4	0.32	0	6,6,6	0.12	0
3	EDO	A	518	-	3,3,3	0.16	0	2,2,2	0.12	0
5	XFV	B	507	-	4,6,6	5.44	2 (50%)	1,9,9	1.15	0
3	EDO	B	503	-	3,3,3	0.30	0	2,2,2	0.34	0
6	SO4	A	514	-	4,4,4	0.57	0	6,6,6	0.19	0
5	XFV	A	509	-	4,6,6	5.44	3 (75%)	1,9,9	1.07	0

In the following table, the Chirals column lists the number of chiral outliers, the number of chiral centers analysed, the number of these observed in the model and the number defined in the Chemical Component Dictionary. Similar counts are reported in the Torsion and Rings columns. '-' means no outliers of that kind were identified.

Mol	Type	Chain	Res	Link	Chirals	Torsions	Rings
3	EDO	A	516	-	-	0/1/1/1	-
5	XFV	A	511	-	-	-	0/1/1/1
5	XFV	A	510	-	-	-	0/1/1/1
2	LU8	A	507	-	-	0/18/28/28	0/4/4/4
3	EDO	B	510	-	-	1/1/1/1	-
5	XFV	B	506	-	-	-	0/1/1/1
3	EDO	A	504	-	-	1/1/1/1	-
3	EDO	A	517	-	-	1/1/1/1	-
2	LU8	A	508	-	-	3/18/28/28	0/4/4/4
5	XFV	A	512	-	-	-	0/1/1/1
3	EDO	B	511	-	-	0/1/1/1	-
3	EDO	A	519	-	-	0/1/1/1	-
3	EDO	A	503	-	-	1/1/1/1	-
2	LU8	A	501[A]	-	-	0/18/28/28	0/4/4/4
2	LU8	A	501[B]	-	-	0/18/28/28	0/4/4/4
2	LU8	B	501	-	-	0/18/28/28	0/4/4/4
3	EDO	A	502	-	-	0/1/1/1	-
5	XFV	B	505	-	-	-	0/1/1/1
3	EDO	A	505	-	-	1/1/1/1	-
3	EDO	B	512	-	-	0/1/1/1	-
3	EDO	A	518	-	-	1/1/1/1	-
5	XFV	B	507	-	-	-	0/1/1/1
3	EDO	B	503	-	-	0/1/1/1	-
5	XFV	A	509	-	-	-	0/1/1/1

The worst 5 of 15 bond length outliers are listed below:

Mol	Chain	Res	Type	Atoms	Z	Observed(Å)	Ideal(Å)
5	A	511	XFV	C05-C06	7.86	1.68	1.54
5	B	507	XFV	C05-C06	7.74	1.68	1.54
5	A	509	XFV	C05-C04	7.64	1.67	1.54
5	A	512	XFV	C05-C06	7.54	1.67	1.54
5	B	505	XFV	C05-C06	7.40	1.67	1.54

The worst 5 of 56 bond angle outliers are listed below:

Mol	Chain	Res	Type	Atoms	Z	Observed(°)	Ideal(°)
2	A	507	LU8	C07-C06-C05	-5.24	111.98	119.56
2	A	501[B]	LU8	C21-C20-N18	4.41	116.88	111.20
2	A	501[B]	LU8	C20-N18-C17	4.39	116.53	109.54
2	A	507	LU8	C26-C05-C06	-4.28	113.42	120.61
2	A	501[A]	LU8	C17-C16-C15	4.16	115.88	111.00

There are no chirality outliers.

5 of 9 torsion outliers are listed below:

Mol	Chain	Res	Type	Atoms
3	A	518	EDO	O1-C1-C2-O2
3	A	517	EDO	O1-C1-C2-O2
3	A	504	EDO	O1-C1-C2-O2
2	A	508	LU8	C04-C05-C06-C07
3	A	505	EDO	O1-C1-C2-O2

There are no ring outliers.

7 monomers are involved in 7 short contacts:

Mol	Chain	Res	Type	Clashes	Symm-Clashes
2	A	507	LU8	1	0
4	B	504	DMS	1	0
5	B	506	XFV	1	0
2	A	501[B]	LU8	1	0
2	B	501	LU8	1	0
5	B	507	XFV	1	0
3	B	503	EDO	1	0

The following is a two-dimensional graphical depiction of Mogul quality analysis of bond lengths, bond angles, torsion angles, and ring geometry for all instances of the Ligand of Interest. In addition, ligands with molecular weight > 250 and outliers as shown on the validation Tables will also be included. For torsion angles, if less than 5% of the Mogul distribution of torsion angles is within 10 degrees of the torsion angle in question, then that torsion angle is considered an outlier.

Any bond that is central to one or more torsion angles identified as an outlier by Mogul will be highlighted in the graph. For rings, the root-mean-square deviation (RMSD) between the ring in question and similar rings identified by Mogul is calculated over all ring torsion angles. If the average RMSD is greater than 60 degrees and the minimal RMSD between the ring in question and any Mogul-identified rings is also greater than 60 degrees, then that ring is considered an outlier. The outliers are highlighted in purple. The color gray indicates Mogul did not find sufficient equivalents in the CSD to analyse the geometry.

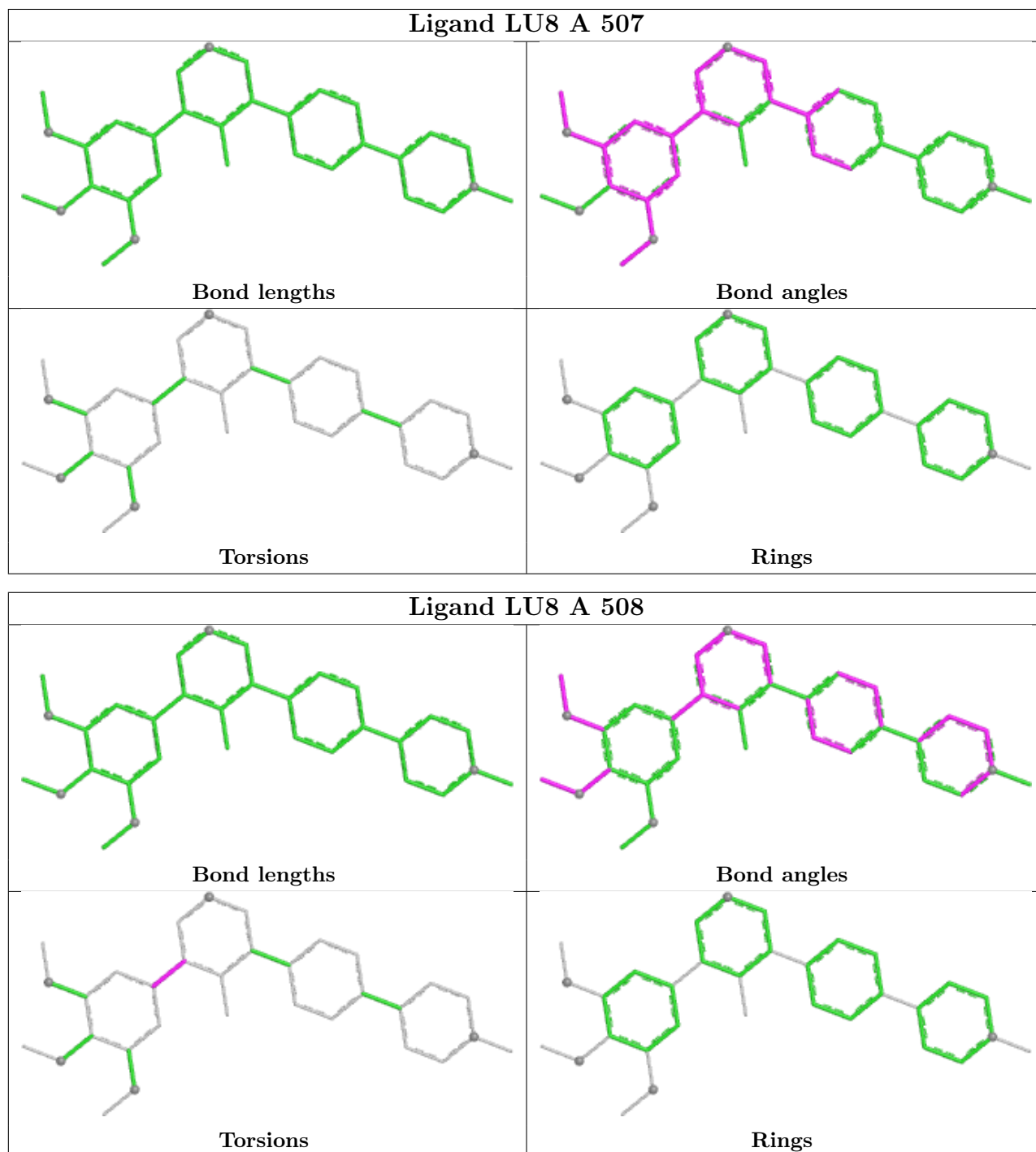

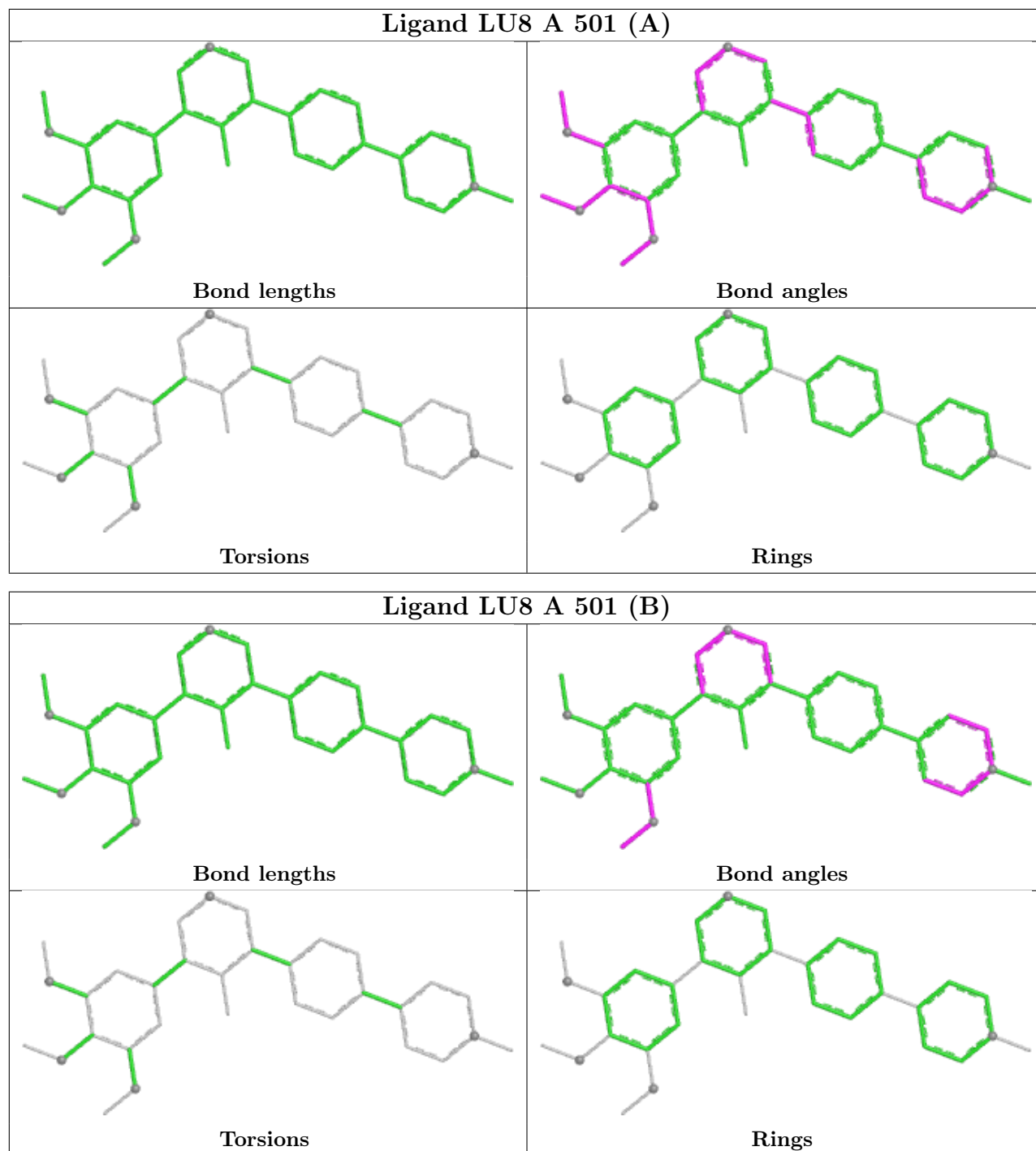

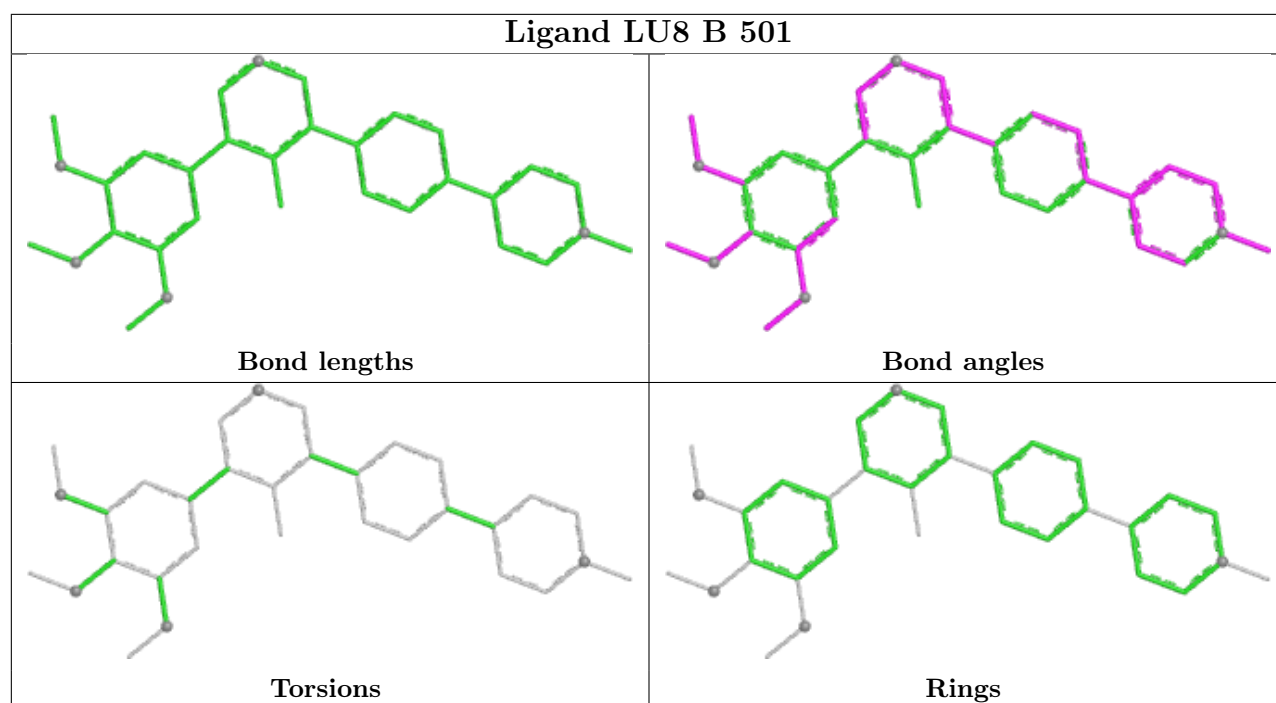

## 5.7 Other polymers [i](#)

There are no such residues in this entry.

## 5.8 Polymer linkage issues [i](#)

There are no chain breaks in this entry.

## 6 Fit of model and data [i](#)

### 6.1 Protein, DNA and RNA chains [i](#)

In the following table, the column labelled ‘#RSRZ> 2’ contains the number (and percentage) of RSRZ outliers, followed by percent RSRZ outliers for the chain as percentile scores relative to all X-ray entries and entries of similar resolution. The OWAB column contains the minimum, median, 95<sup>th</sup> percentile and maximum values of the occupancy-weighted average B-factor per residue. The column labelled ‘Q< 0.9’ lists the number of (and percentage) of residues with an average occupancy less than 0.9.

Mol	Chain	Analysed	<RSRZ>	#RSRZ>2	OWAB(Å <sup>2</sup> )	Q<0.9
1	A	284/301 (94%)	0.29	22 (7%) 19 22	8, 22, 46, 79	13 (4%)
1	B	292/301 (97%)	0.26	14 (4%) 35 41	8, 22, 42, 68	7 (2%)
All	All	576/602 (95%)	0.27	36 (6%) 26 29	8, 22, 45, 79	20 (3%)

The worst 5 of 36 RSRZ outliers are listed below:

Mol	Chain	Res	Type	RSRZ
1	B	227	TRP	5.0
1	A	219	TYR	4.9
1	B	324	PHE	4.3
1	B	205	ALA	4.2
1	B	219	TYR	3.7

### 6.2 Non-standard residues in protein, DNA, RNA chains [i](#)

There are no non-standard protein/DNA/RNA residues in this entry.

### 6.3 Carbohydrates [i](#)

There are no oligosaccharides in this entry.

### 6.4 Ligands [i](#)

In the following table, the Atoms column lists the number of modelled atoms in the group and the number defined in the chemical component dictionary. The B-factors column lists the minimum, median, 95<sup>th</sup> percentile and maximum values of B factors of atoms in the group. The column labelled ‘Q< 0.9’ lists the number of atoms with occupancy less than 0.9.

Mol	Type	Chain	Res	Atoms	RSCC	RSR	B-factors( $\text{\AA}^2$ )	Q<0.9
4	DMS	B	504	4/4	0.70	0.21	70,73,76,77	0
6	SO4	B	508	5/5	0.70	0.14	68,69,70,81	5
4	DMS	A	506	4/4	0.71	0.30	82,86,90,90	0
5	XFV	B	506	6/6	0.75	0.23	60,61,62,63	6
3	EDO	A	518	4/4	0.79	0.18	49,51,52,59	0
3	EDO	A	519	4/4	0.79	0.14	44,49,51,53	0
3	EDO	A	504	4/4	0.80	0.18	51,56,57,57	0
6	SO4	B	509	5/5	0.80	0.13	59,63,68,73	0
2	LU8	A	507	32/32	0.81	0.16	35,41,55,56	0
3	EDO	A	517	4/4	0.83	0.17	44,47,54,60	0
5	XFV	B	507	6/6	0.83	0.21	60,64,69,72	0
3	EDO	B	512	4/4	0.84	0.16	50,52,53,54	0
5	XFV	A	511	6/6	0.84	0.20	45,48,51,52	6
3	EDO	A	516	4/4	0.84	0.23	69,69,70,72	0
3	EDO	B	503	4/4	0.85	0.17	32,38,39,54	0
3	EDO	A	503	4/4	0.86	0.13	29,32,33,33	0
3	EDO	B	511	4/4	0.86	0.15	39,47,48,49	0
2	LU8	A	508	32/32	0.88	0.13	26,31,54,63	0
5	XFV	A	512	6/6	0.88	0.19	34,39,42,42	6
3	EDO	B	510	4/4	0.88	0.15	28,33,36,36	0
3	EDO	A	502	4/4	0.90	0.15	20,28,34,43	0
5	XFV	A	510	6/6	0.90	0.16	40,45,48,48	6
2	LU8	A	501[A]	32/32	0.90	0.12	16,21,37,42	32
2	LU8	A	501[B]	32/32	0.90	0.12	18,22,30,30	32
3	EDO	A	505	4/4	0.92	0.11	21,28,29,32	0
5	XFV	B	505	6/6	0.94	0.11	38,40,41,43	0
2	LU8	B	501	32/32	0.95	0.09	18,20,39,44	0
6	SO4	A	514	5/5	0.97	0.06	26,27,30,37	0
6	SO4	A	515	5/5	0.97	0.08	22,24,27,27	5
6	SO4	B	502	5/5	0.97	0.06	25,28,30,30	0
5	XFV	A	509	6/6	0.97	0.09	21,26,27,27	6
6	SO4	A	513	5/5	0.97	0.10	26,27,31,32	0

The following is a graphical depiction of the model fit to experimental electron density of all instances of the Ligand of Interest. In addition, ligands with molecular weight > 250 and outliers as shown on the geometry validation Tables will also be included. Each fit is shown from different orientation to approximate a three-dimensional view.

**Electron density around LU8 A 507:**

$2mF_o-DF_c$  (at 0.7 rmsd) in gray  
 $mF_o-DF_c$  (at 3 rmsd) in purple (negative)  
and green (positive)

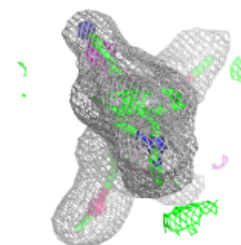
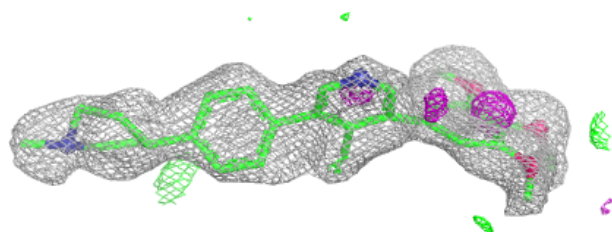
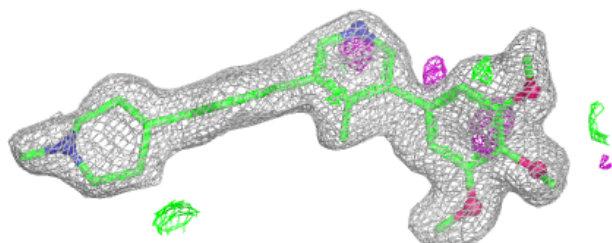
**Electron density around LU8 A 508:**

$2mF_o-DF_c$  (at 0.7 rmsd) in gray  
 $mF_o-DF_c$  (at 3 rmsd) in purple (negative)  
and green (positive)

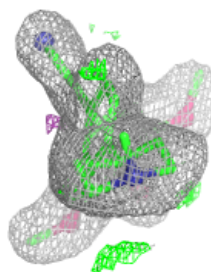
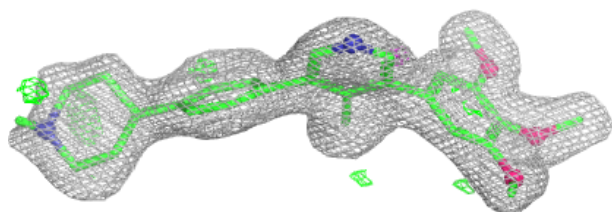
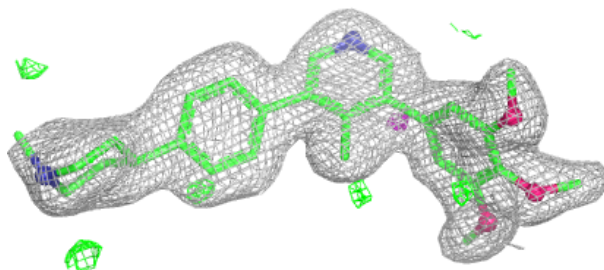

**Electron density around LU8 A 501 (A):**

$2mF_o-DF_c$  (at 0.7 rmsd) in gray  
 $mF_o-DF_c$  (at 3 rmsd) in purple (negative)  
and green (positive)

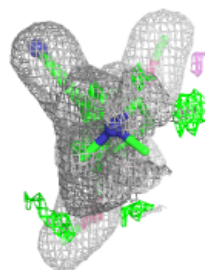
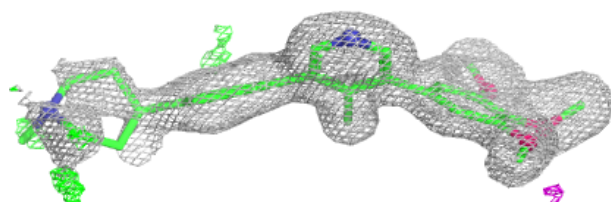
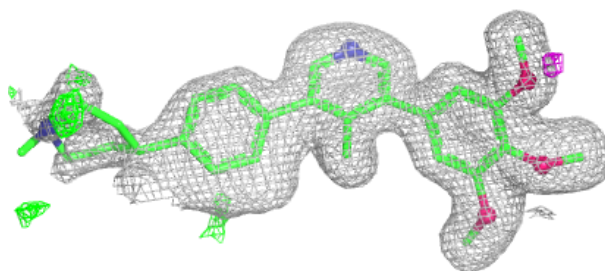
**Electron density around LU8 A 501 (B):**

$2mF_o-DF_c$  (at 0.7 rmsd) in gray  
 $mF_o-DF_c$  (at 3 rmsd) in purple (negative)  
and green (positive)

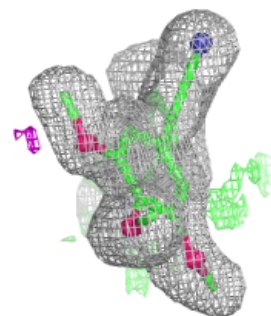
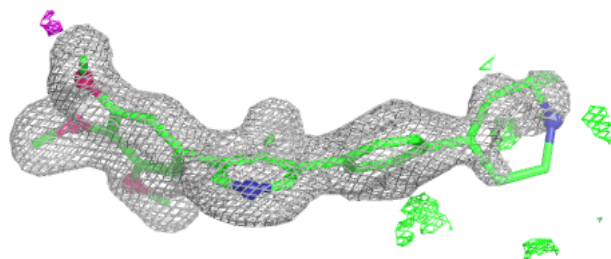
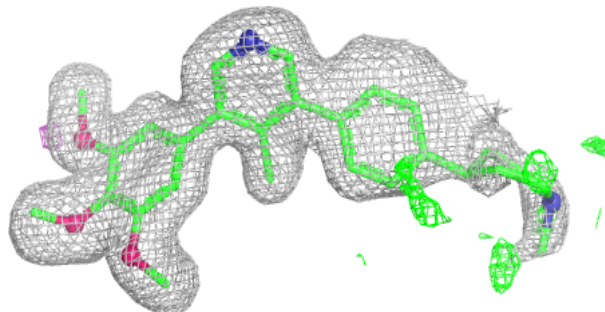

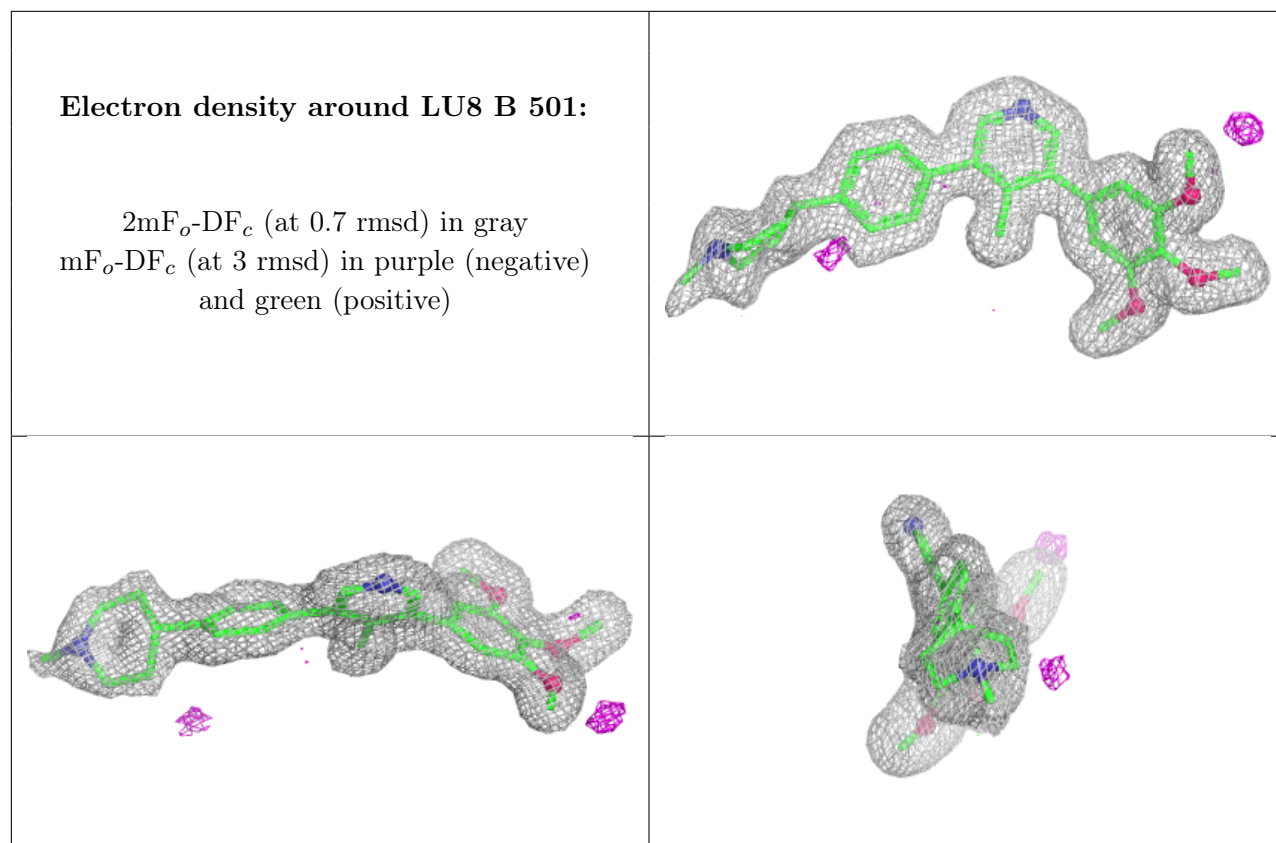

## 6.5 Other polymers [i](#)

There are no such residues in this entry.