



wwPDB X-ray Structure Validation Summary Report ⓘ

Mar 7, 2026 – 02:04 AM UTC

PDB ID : 8SIT / pdb_00008sit
Title : Crystal structure of SARS-CoV-2 spike receptor-binding domain in complex with broadly neutralizing antibody CC84.24 Fab
Authors : Liu, H.; Wilson, I.A.
Deposited on : 2023-04-16
Resolution : 2.91 Å(reported)

This is a wwPDB X-ray Structure Validation Summary Report for a publicly released PDB entry.

We welcome your comments at validation@mail.wwpdb.org

A user guide is available at

<https://www.wwpdb.org/validation/2017/XrayValidationReportHelp>

with specific help available everywhere you see the ⓘ symbol.

The types of validation reports are described at

<http://www.wwpdb.org/validation/2017/FAQs#types>.

The following versions of software and data (see [references ⓘ](#)) were used in the production of this report:

MolProbity : 4-5-2 with Phenix2.0
Mogul : 2022.3.0, CSD as543be (2022)
Xtriage (Phenix) : 2.0
EDS : 3.0
Percentile statistics : 20250101.v01 (using entries in the PDB archive January 1st 2025)
CCP4 : 9.0.010 (Gargrove)
Density-Fitness : 1.0.12
Ideal geometry (proteins) : Engh & Huber (2001)
Ideal geometry (DNA, RNA) : Parkinson et al. (1996)
Validation Pipeline (wwPDB-VP) : 2.49

1 Overall quality at a glance

The following experimental techniques were used to determine the structure:

X-RAY DIFFRACTION

The reported resolution of this entry is 2.91 Å.

Percentile scores (ranging between 0-100) for global validation metrics of the entry are shown in the following graphic. The table shows the number of entries on which the scores are based.

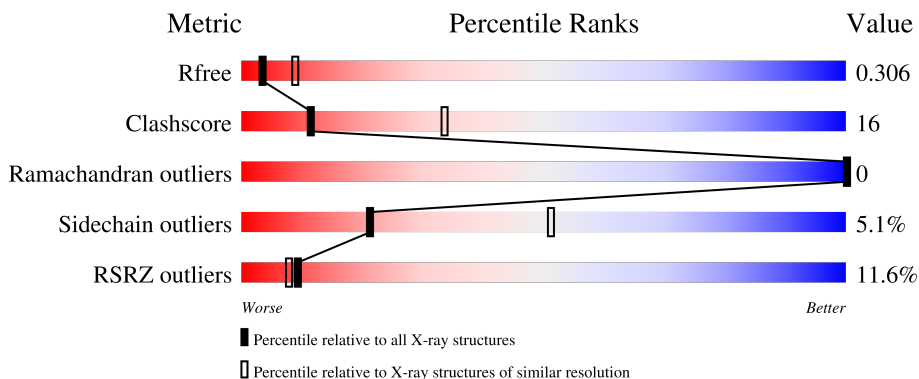

Metric	Whole archive (#Entries)	Similar resolution (#Entries, resolution range(Å))
R_{free}	180053	2995 (2.94-2.90)
Clashscore	190562	3213 (2.94-2.90)
Ramachandran outliers	187476	3128 (2.94-2.90)
Sidechain outliers	187428	3130 (2.94-2.90)
RSRZ outliers	180081	2995 (2.94-2.90)

The table below summarises the geometric issues observed across the polymeric chains and their fit to the electron density. The red, orange, yellow and green segments of the lower bar indicate the fraction of residues that contain outliers for ≥ 3 , 2, 1 and 0 types of geometric quality criteria respectively. A grey segment represents the fraction of residues that are not modelled. The numeric value for each fraction is indicated below the corresponding segment, with a dot representing fractions $\leq 5\%$. The upper red bar (where present) indicates the fraction of residues that have poor fit to the electron density. The numeric value is given above the bar.

Mol	Chain	Length	Quality of chain
1	A	205	
1	B	205	
1	C	205	
1	D	205	
2	H	231	

Continued on next page...

Continued from previous page...

Mol	Chain	Length	Quality of chain
2	M	231	<p>3% 70% 29% ..</p>
2	O	231	<p>12% 61% 32% ..</p>
2	Q	231	<p>28% 61% 27% 8%</p>
3	L	214	<p>7% 64% 33% .</p>
3	N	214	<p>5% 64% 32% ..</p>
3	P	214	<p>14% 71% 26% ..</p>
3	S	214	<p>24% 65% 27% 5%</p>

2 Entry composition i

There are 4 unique types of molecules in this entry. The entry contains 18011 atoms, of which 0 are hydrogens and 0 are deuteriums.

In the tables below, the ZeroOcc column contains the number of atoms modelled with zero occupancy, the AltConf column contains the number of residues with at least one atom in alternate conformation and the Trace column contains the number of residues modelled with at most 2 atoms.

- Molecule 1 is a protein called Spike protein S1.

Mol	Chain	Residues	Atoms					ZeroOcc	AltConf	Trace
			Total	C	N	O	S			
1	A	195	1508	966	251	283	8	0	0	0
1	B	195	1484	950	245	281	8	0	0	0
1	C	195	1508	969	250	281	8	0	0	0
1	D	191	1329	838	230	253	8	0	0	0

There are 28 discrepancies between the modelled and reference sequences:

Chain	Residue	Modelled	Actual	Comment	Reference
A	531	GLY	-	expression tag	UNP P0DTC2
A	532	HIS	-	expression tag	UNP P0DTC2
A	533	HIS	-	expression tag	UNP P0DTC2
A	534	HIS	-	expression tag	UNP P0DTC2
A	535	HIS	-	expression tag	UNP P0DTC2
A	536	HIS	-	expression tag	UNP P0DTC2
A	537	HIS	-	expression tag	UNP P0DTC2
B	531	GLY	-	expression tag	UNP P0DTC2
B	532	HIS	-	expression tag	UNP P0DTC2
B	533	HIS	-	expression tag	UNP P0DTC2
B	534	HIS	-	expression tag	UNP P0DTC2
B	535	HIS	-	expression tag	UNP P0DTC2
B	536	HIS	-	expression tag	UNP P0DTC2
B	537	HIS	-	expression tag	UNP P0DTC2
C	531	GLY	-	expression tag	UNP P0DTC2
C	532	HIS	-	expression tag	UNP P0DTC2
C	533	HIS	-	expression tag	UNP P0DTC2
C	534	HIS	-	expression tag	UNP P0DTC2
C	535	HIS	-	expression tag	UNP P0DTC2
C	536	HIS	-	expression tag	UNP P0DTC2
C	537	HIS	-	expression tag	UNP P0DTC2

Continued on next page...

Continued from previous page...

Chain	Residue	Modelled	Actual	Comment	Reference
D	531	GLY	-	expression tag	UNP P0DTC2
D	532	HIS	-	expression tag	UNP P0DTC2
D	533	HIS	-	expression tag	UNP P0DTC2
D	534	HIS	-	expression tag	UNP P0DTC2
D	535	HIS	-	expression tag	UNP P0DTC2
D	536	HIS	-	expression tag	UNP P0DTC2
D	537	HIS	-	expression tag	UNP P0DTC2

- Molecule 2 is a protein called CC84.24 fab heavy chain.

Mol	Chain	Residues	Atoms					ZeroOcc	AltConf	Trace
			Total	C	N	O	S			
2	H	221	Total	C	N	O	S	0	0	0
			1618	1022	273	316	7			
2	M	229	Total	C	N	O	S	0	0	0
			1681	1060	285	329	7			
2	O	224	Total	C	N	O	S	0	0	0
			1611	1012	276	316	7			
2	Q	212	Total	C	N	O	S	0	0	0
			1414	884	246	279	5			

- Molecule 3 is a protein called CC84.24 fab light chain.

Mol	Chain	Residues	Atoms					ZeroOcc	AltConf	Trace
			Total	C	N	O	S			
3	L	210	Total	C	N	O	S	0	0	0
			1508	944	254	306	4			
3	N	209	Total	C	N	O	S	0	0	0
			1520	950	255	311	4			
3	P	208	Total	C	N	O	S	0	0	0
			1439	901	243	291	4			
3	S	204	Total	C	N	O	S	0	0	0
			1363	849	234	276	4			

- Molecule 4 is 2-acetamido-2-deoxy-beta-D-glucopyranose (CCD ID: NAG) (formula: C₈H₁₅NO₆).



Mol	Chain	Residues	Atoms				ZeroOcc	AltConf
			Total	C	N	O		
4	A	1	14	8	1	5	0	0
4	D	1	14	8	1	5	0	0

3 Residue-property plots [i](#)

These plots are drawn for all protein, RNA, DNA and oligosaccharide chains in the entry. The first graphic for a chain summarises the proportions of the various outlier classes displayed in the second graphic. The second graphic shows the sequence view annotated by issues in geometry and electron density. Residues are color-coded according to the number of geometric quality criteria for which they contain at least one outlier: green = 0, yellow = 1, orange = 2 and red = 3 or more. A red dot above a residue indicates a poor fit to the electron density ($RSRZ > 2$). Stretches of 2 or more consecutive residues without any outlier are shown as a green connector. Residues present in the sample, but not in the model, are shown in grey.

- Molecule 1: Spike protein S1

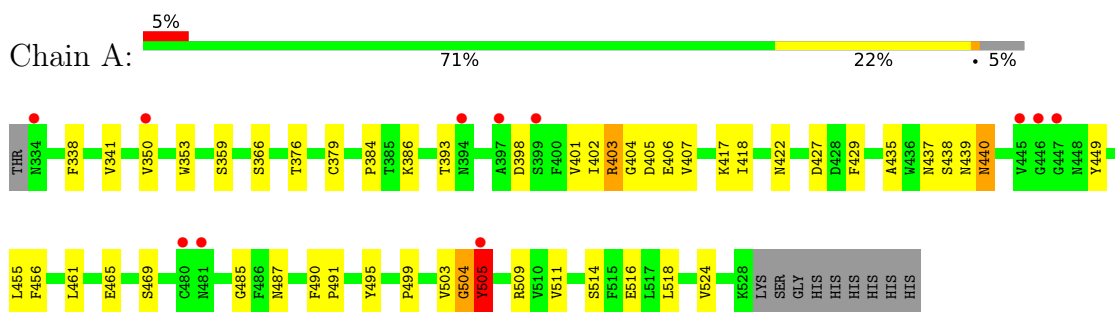

- Molecule 1: Spike protein S1

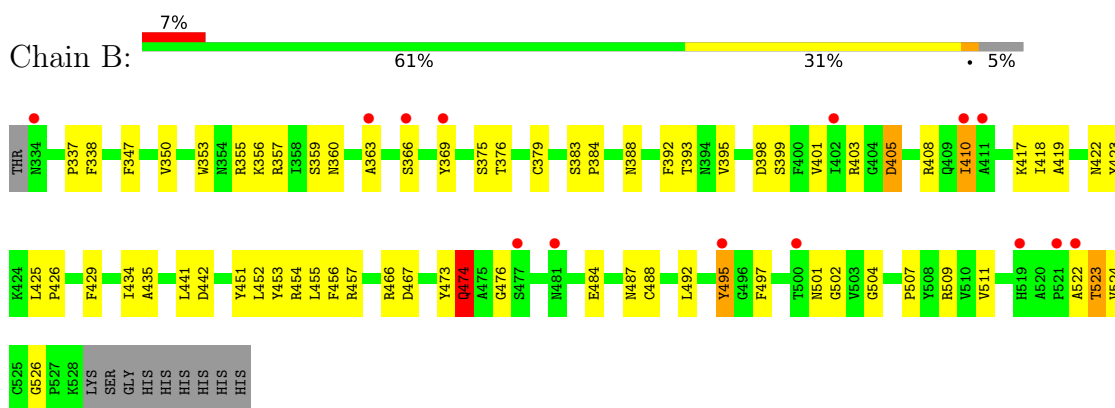

- Molecule 1: Spike protein S1

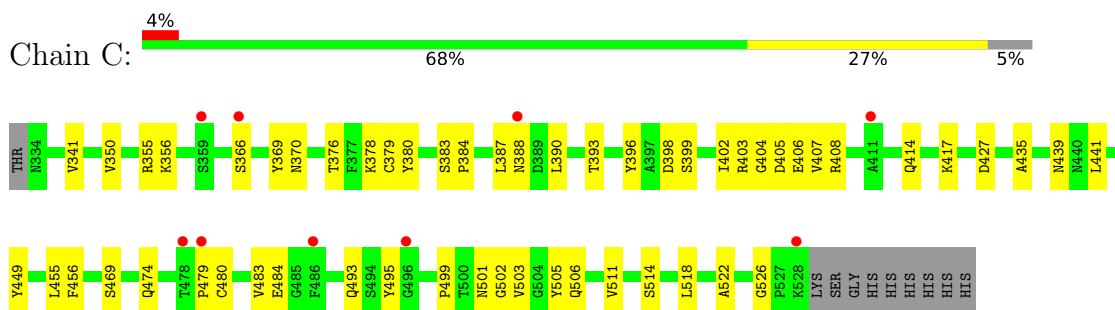

- Molecule 1: Spike protein S1



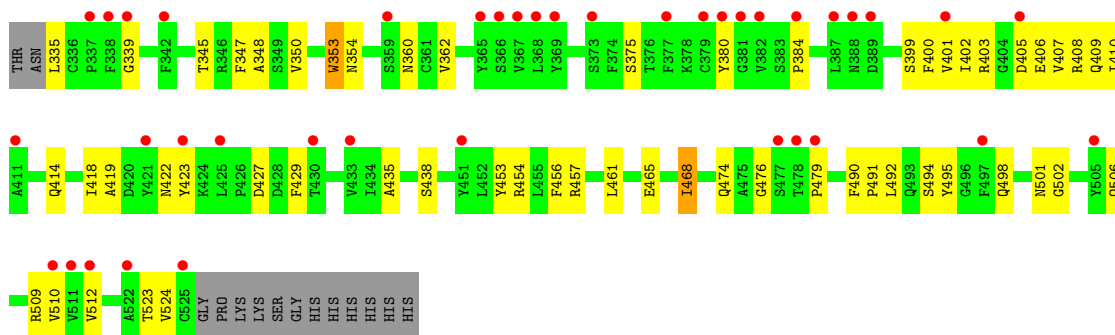

- Molecule 2: CC84.24 fab heavy chain

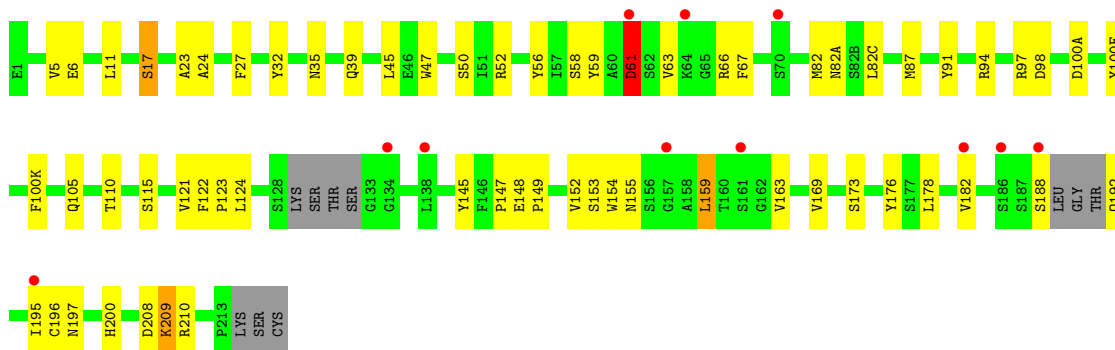

- Molecule 2: CC84.24 fab heavy chain

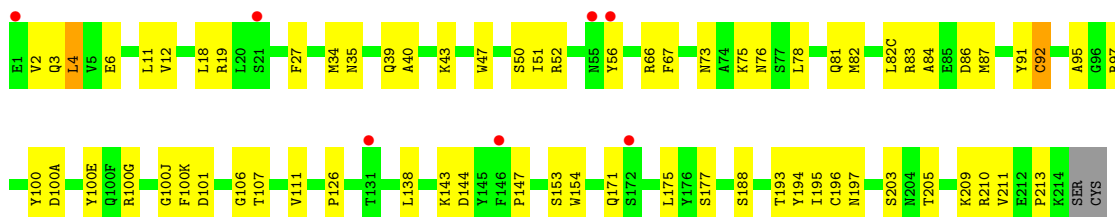

- Molecule 2: CC84.24 fab heavy chain

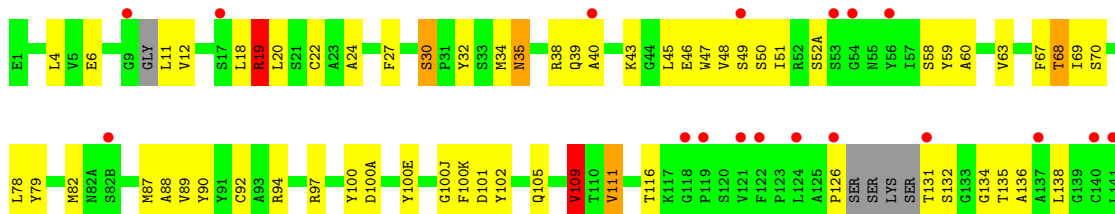

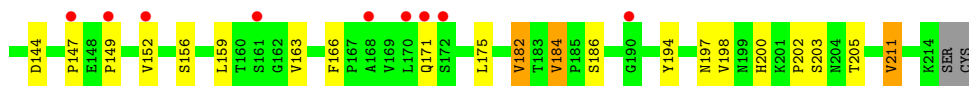

- Molecule 2: CC84.24 fab heavy chain

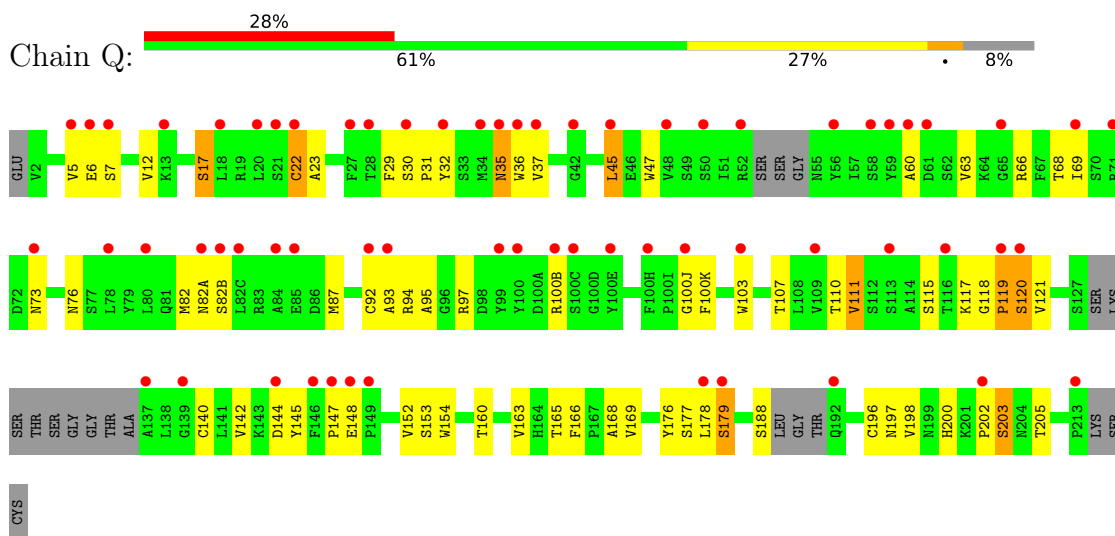

- Molecule 3: CC84.24 fab light chain

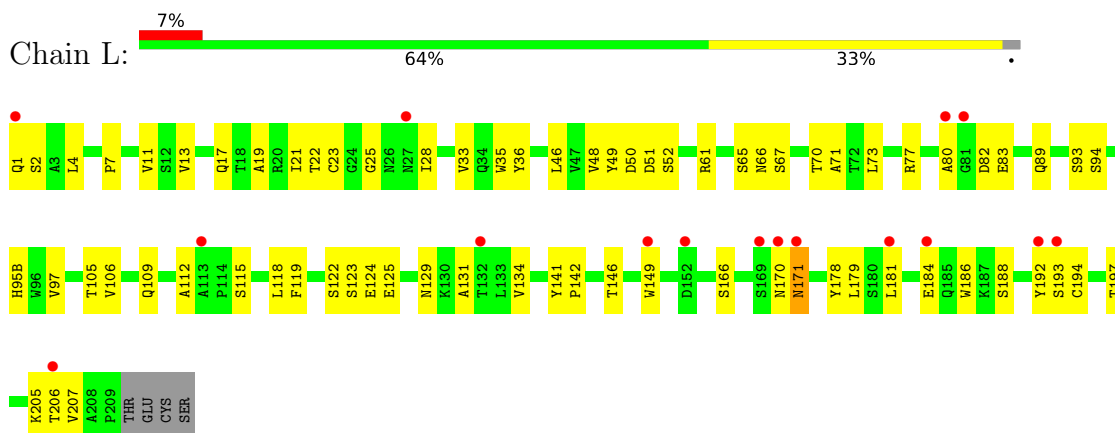

- Molecule 3: CC84.24 fab light chain

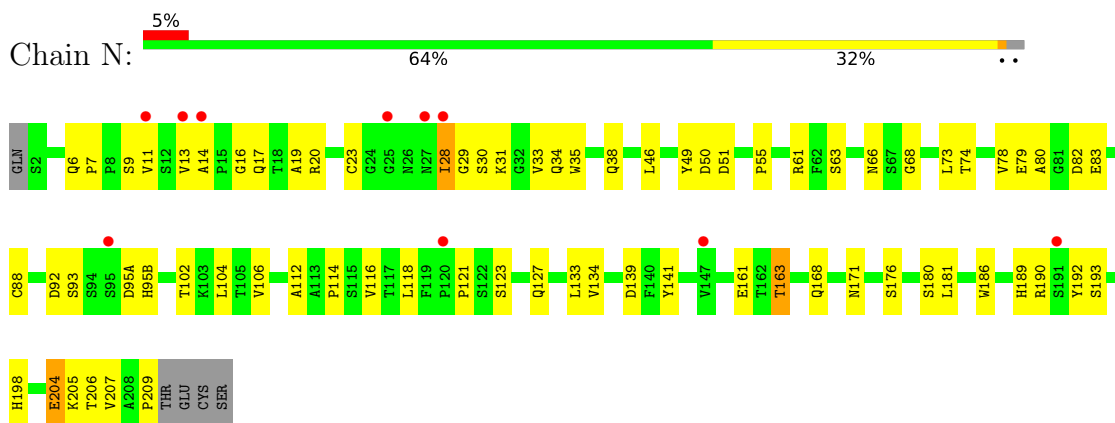

- Molecule 3: CC84.24 fab light chain

Chain P:  14% 71% 26% ..

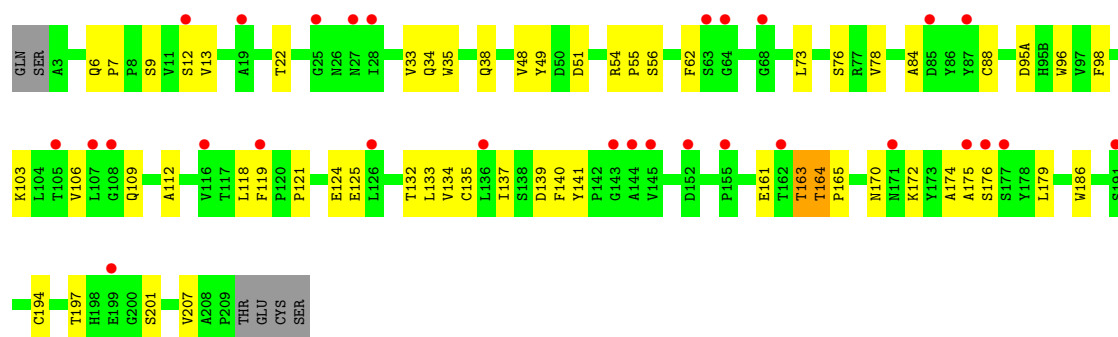

• Molecule 3: CC84.24 fab light chain

Chain S:  24% 65% 27% • 5%

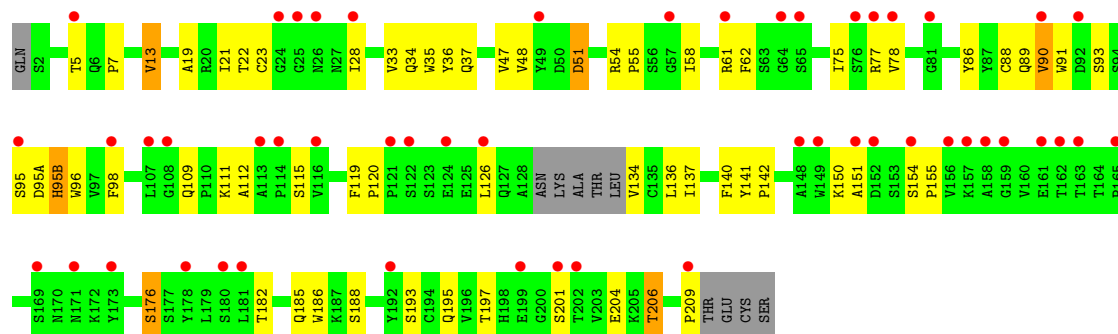

4 Data and refinement statistics i

Property	Value	Source
Space group	P 21 21 21	Depositor
Cell constants a, b, c, α , β , γ	101.39Å 105.98Å 247.04Å 90.00° 90.00° 90.00°	Depositor
Resolution (Å)	48.70 – 2.91 48.70 – 2.91	Depositor EDS
% Data completeness (in resolution range)	78.5 (48.70-2.91) 78.5 (48.70-2.91)	Depositor EDS
R_{merge}	0.21	Depositor
R_{sym}	(Not available)	Depositor
$\langle I/\sigma(I) \rangle$ ¹	1.80 (at 2.91Å)	Xtrriage
Refinement program	PHENIX (1.19.2_4158: ???)	Depositor
R, R_{free}	0.261 , 0.309 0.259 , 0.306	Depositor DCC
R_{free} test set	2275 reflections (3.84%)	wwPDB-VP
Wilson B-factor (Å ²)	55.6	Xtrriage
Anisotropy	0.102	Xtrriage
Bulk solvent k_{sol} (e/Å ³), B_{sol} (Å ²)	0.29 , 62.5	EDS
L-test for twinning ²	$\langle L \rangle = 0.46$, $\langle L^2 \rangle = 0.29$	Xtrriage
Estimated twinning fraction	0.033 for k,h,-l	Xtrriage
F_o, F_c correlation	0.85	EDS
Total number of atoms	18011	wwPDB-VP
Average B, all atoms (Å ²)	65.0	wwPDB-VP

Xtrriage's analysis on translational NCS is as follows: *The largest off-origin peak in the Patterson function is 2.73% of the height of the origin peak. No significant pseudotranslation is detected.*

¹Intensities estimated from amplitudes.

²Theoretical values of $\langle |L| \rangle$, $\langle L^2 \rangle$ for acentric reflections are 0.5, 0.333 respectively for untwinned datasets, and 0.375, 0.2 for perfectly twinned datasets.

5 Model quality i

5.1 Standard geometry i

Bond lengths and bond angles in the following residue types are not validated in this section: NAG

The Z score for a bond length (or angle) is the number of standard deviations the observed value is removed from the expected value. A bond length (or angle) with $|Z| > 5$ is considered an outlier worth inspection. RMSZ is the root-mean-square of all Z scores of the bond lengths (or angles).

Mol	Chain	Bond lengths		Bond angles	
		RMSZ	# Z >5	RMSZ	# Z >5
1	A	0.19	0/1552	0.50	3/2117 (0.1%)
1	B	0.30	0/1527	0.51	4/2086 (0.2%)
1	C	0.16	0/1551	0.42	0/2114
1	D	0.20	0/1363	0.48	0/1873
2	H	0.33	1/1659 (0.1%)	0.65	6/2265 (0.3%)
2	M	0.15	0/1724	0.42	0/2355
2	O	0.41	2/1651 (0.1%)	0.68	5/2258 (0.2%)
2	Q	0.33	0/1447	0.67	4/1993 (0.2%)
3	L	0.23	0/1548	0.57	1/2130 (0.0%)
3	N	0.18	0/1560	0.46	0/2145
3	P	0.27	0/1477	0.59	0/2038
3	S	0.42	1/1399 (0.1%)	0.70	3/1932 (0.2%)
All	All	0.28	4/18458 (0.0%)	0.56	26/25306 (0.1%)

Chiral center outliers are detected by calculating the chiral volume of a chiral center and verifying if the center is modelled as a planar moiety or with the opposite hand. A planarity outlier is detected by checking planarity of atoms in a peptide group, atoms in a mainchain group or atoms of a sidechain that are expected to be planar.

Mol	Chain	#Chirality outliers	#Planarity outliers
1	A	0	2
1	B	0	1
2	H	0	1
2	O	0	2
2	Q	0	1
3	L	0	1
All	All	0	8

All (4) bond length outliers are listed below:

Mol	Chain	Res	Type	Atoms	Z	Observed(Å)	Ideal(Å)
3	S	120	PRO	CA-C	-9.00	1.43	1.52
2	H	61	ASP	CG-OD1	7.08	1.38	1.25
2	O	184	VAL	C-O	5.38	1.31	1.24
2	O	184	VAL	CA-C	-5.14	1.47	1.52

The worst 5 of 26 bond angle outliers are listed below:

Mol	Chain	Res	Type	Atoms	Z	Observed(°)	Ideal(°)
1	A	505	TYR	N-CA-CB	-8.62	96.35	110.40
2	H	61	ASP	CB-CA-C	8.03	124.12	110.79
2	H	159	LEU	CB-CG-CD2	-7.30	88.79	110.70
1	A	504	GLY	CA-C-N	7.09	133.55	121.14
1	A	504	GLY	C-N-CA	7.09	133.55	121.14

There are no chirality outliers.

5 of 8 planarity outliers are listed below:

Mol	Chain	Res	Type	Group
1	A	403	ARG	Sidechain
1	A	505	TYR	Sidechain
1	B	474	GLN	Sidechain
2	H	61	ASP	Sidechain
3	L	170	ASN	Peptide

5.2 Too-close contacts [i](#)

In the following table, the Non-H and H(model) columns list the number of non-hydrogen atoms and hydrogen atoms in the chain respectively. The H(added) column lists the number of hydrogen atoms added and optimized by MolProbity. The Clashes column lists the number of clashes within the asymmetric unit, whereas Symm-Clashes lists symmetry-related clashes.

Mol	Chain	Non-H	H(model)	H(added)	Clashes	Symm-Clashes
1	A	1508	0	1371	35	0
1	B	1484	0	1325	52	0
1	C	1508	0	1390	34	1
1	D	1329	0	1088	51	0
2	H	1618	0	1497	48	1
2	M	1681	0	1571	52	1
2	O	1611	0	1454	70	0
2	Q	1414	0	1177	61	0
3	L	1508	0	1387	50	1
3	N	1520	0	1407	51	0

Continued on next page...

Continued from previous page...

Mol	Chain	Non-H	H(model)	H(added)	Clashes	Symm-Clashes
3	P	1439	0	1263	47	0
3	S	1363	0	1133	44	0
4	A	14	0	13	1	0
4	D	14	0	13	1	0
All	All	18011	0	16089	549	2

The all-atom clashscore is defined as the number of clashes found per 1000 atoms (including hydrogen atoms). The all-atom clashscore for this structure is 16.

The worst 5 of 549 close contacts within the same asymmetric unit are listed below, sorted by their clash magnitude.

Atom-1	Atom-2	Interatomic distance (Å)	Clash overlap (Å)
3:S:193:SER:HB3	3:S:206:THR:HG23	1.33	1.10
3:S:193:SER:HB3	3:S:206:THR:CG2	1.83	1.07
1:B:474:GLN:NE2	1:B:476:GLY:O	1.93	1.00
2:H:123:PRO:HG3	2:H:209:LYS:HE3	1.50	0.93
2:M:6:GLU:OE2	2:M:92:CYS:N	2.02	0.92

All (2) symmetry-related close contacts are listed below. The label for Atom-2 includes the symmetry operator and encoded unit-cell translations to be applied.

Atom-1	Atom-2	Interatomic distance (Å)	Clash overlap (Å)
1:C:441:LEU:O	3:L:94:SER:OG[4_545]	2.16	0.04
2:H:173:SER:O	2:M:100(E):TYR:OH[4_445]	2.17	0.03

5.3 Torsion angles [i](#)

5.3.1 Protein backbone [i](#)

In the following table, the Percentiles column shows the percent Ramachandran outliers of the chain as a percentile score with respect to all X-ray entries followed by that with respect to entries of similar resolution.

The Analysed column shows the number of residues for which the backbone conformation was analysed, and the total number of residues.

Mol	Chain	Analysed	Favoured	Allowed	Outliers	Percentiles
1	A	193/205 (94%)	191 (99%)	2 (1%)	0	100 100
1	B	193/205 (94%)	190 (98%)	3 (2%)	0	100 100

Continued on next page...

Continued from previous page...

Mol	Chain	Analysed	Favoured	Allowed	Outliers	Percentiles	
1	C	193/205 (94%)	189 (98%)	4 (2%)	0	100	100
1	D	189/205 (92%)	185 (98%)	4 (2%)	0	100	100
2	H	215/231 (93%)	209 (97%)	6 (3%)	0	100	100
2	M	227/231 (98%)	220 (97%)	7 (3%)	0	100	100
2	O	218/231 (94%)	213 (98%)	5 (2%)	0	100	100
2	Q	204/231 (88%)	196 (96%)	8 (4%)	0	100	100
3	L	208/214 (97%)	203 (98%)	5 (2%)	0	100	100
3	N	207/214 (97%)	205 (99%)	2 (1%)	0	100	100
3	P	206/214 (96%)	201 (98%)	5 (2%)	0	100	100
3	S	200/214 (94%)	193 (96%)	7 (4%)	0	100	100
All	All	2453/2600 (94%)	2395 (98%)	58 (2%)	0	100	100

There are no Ramachandran outliers to report.

5.3.2 Protein sidechains [i](#)

In the following table, the Percentiles column shows the percent sidechain outliers of the chain as a percentile score with respect to all X-ray entries followed by that with respect to entries of similar resolution.

The Analysed column shows the number of residues for which the sidechain conformation was analysed, and the total number of residues.

Mol	Chain	Analysed	Rotameric	Outliers	Percentiles	
1	A	155/177 (88%)	150 (97%)	5 (3%)	34	66
1	B	149/177 (84%)	144 (97%)	5 (3%)	32	65
1	C	156/177 (88%)	149 (96%)	7 (4%)	24	56
1	D	114/177 (64%)	109 (96%)	5 (4%)	25	57
2	H	168/193 (87%)	163 (97%)	5 (3%)	36	68
2	M	176/193 (91%)	173 (98%)	3 (2%)	53	80
2	O	161/193 (83%)	151 (94%)	10 (6%)	16	44
2	Q	124/193 (64%)	107 (86%)	17 (14%)	3	11
3	L	157/179 (88%)	146 (93%)	11 (7%)	14	38
3	N	162/179 (90%)	157 (97%)	5 (3%)	35	67
3	P	138/179 (77%)	134 (97%)	4 (3%)	37	69

Continued on next page...

Continued from previous page...

Mol	Chain	Analysed	Rotameric	Outliers	Percentiles
3	S	120/179 (67%)	107 (89%)	13 (11%)	6 20
All	All	1780/2196 (81%)	1690 (95%)	90 (5%)	21 51

5 of 90 residues with a non-rotameric sidechain are listed below:

Mol	Chain	Res	Type
3	P	76	SER
2	Q	140	CYS
3	P	164	THR
2	Q	68	THR
2	Q	188	SER

Sometimes sidechains can be flipped to improve hydrogen bonding and reduce clashes. 5 of 56 such sidechains are listed below:

Mol	Chain	Res	Type
2	H	171	GLN
3	S	37	GLN
3	L	185	GLN
2	Q	200	HIS
2	O	82(A)	ASN

5.3.3 RNA [i](#)

There are no RNA molecules in this entry.

5.4 Non-standard residues in protein, DNA, RNA chains [i](#)

There are no non-standard protein/DNA/RNA residues in this entry.

5.5 Carbohydrates [i](#)

There are no oligosaccharides in this entry.

5.6 Ligand geometry [i](#)

2 ligands are modelled in this entry.

In the following table, the Counts columns list the number of bonds (or angles) for which Mogul statistics could be retrieved, the number of bonds (or angles) that are observed in the model and

the number of bonds (or angles) that are defined in the Chemical Component Dictionary. The Link column lists molecule types, if any, to which the group is linked. The Z score for a bond length (or angle) is the number of standard deviations the observed value is removed from the expected value. A bond length (or angle) with $|Z| > 2$ is considered an outlier worth inspection. RMSZ is the root-mean-square of all Z scores of the bond lengths (or angles).

Mol	Type	Chain	Res	Link	Bond lengths			Bond angles		
					Counts	RMSZ	# Z > 2	Counts	RMSZ	# Z > 2
4	NAG	A	600	1	14,14,15	0.78	1 (7%)	17,19,21	1.38	2 (11%)
4	NAG	D	600	1	14,14,15	0.26	0	17,19,21	0.49	0

In the following table, the Chirals column lists the number of chiral outliers, the number of chiral centers analysed, the number of these observed in the model and the number defined in the Chemical Component Dictionary. Similar counts are reported in the Torsion and Rings columns. '-' means no outliers of that kind were identified.

Mol	Type	Chain	Res	Link	Chirals	Torsions	Rings
4	NAG	A	600	1	-	4/6/23/26	0/1/1/1
4	NAG	D	600	1	-	3/6/23/26	0/1/1/1

All (1) bond length outliers are listed below:

Mol	Chain	Res	Type	Atoms	Z	Observed(Å)	Ideal(Å)
4	A	600	NAG	C1-C2	2.63	1.55	1.52

All (2) bond angle outliers are listed below:

Mol	Chain	Res	Type	Atoms	Z	Observed(°)	Ideal(°)
4	A	600	NAG	C2-N2-C7	4.32	128.70	122.90
4	A	600	NAG	C1-C2-N2	2.45	114.30	110.43

There are no chirality outliers.

5 of 7 torsion outliers are listed below:

Mol	Chain	Res	Type	Atoms
4	A	600	NAG	C8-C7-N2-C2
4	A	600	NAG	O7-C7-N2-C2
4	D	600	NAG	O5-C5-C6-O6
4	D	600	NAG	C1-C2-N2-C7
4	D	600	NAG	C3-C2-N2-C7

There are no ring outliers.

2 monomers are involved in 2 short contacts:

Mol	Chain	Res	Type	Clashes	Symm-Clashes
4	A	600	NAG	1	0
4	D	600	NAG	1	0

5.7 Other polymers [i](#)

There are no such residues in this entry.

5.8 Polymer linkage issues [i](#)

There are no chain breaks in this entry.

6 Fit of model and data [i](#)

6.1 Protein, DNA and RNA chains [i](#)

In the following table, the column labelled ‘#RSRZ> 2’ contains the number (and percentage) of RSRZ outliers, followed by percent RSRZ outliers for the chain as percentile scores relative to all X-ray entries and entries of similar resolution. The OWAB column contains the minimum, median, 95th percentile and maximum values of the occupancy-weighted average B-factor per residue. The column labelled ‘Q< 0.9’ lists the number of (and percentage) of residues with an average occupancy less than 0.9.

Mol	Chain	Analysed	<RSRZ>	#RSRZ>2	OWAB(Å ²)	Q<0.9
1	A	195/205 (95%)	0.39	11 (5%) 30 23	15, 31, 63, 91	0
1	B	195/205 (95%)	0.73	14 (7%) 21 17	37, 63, 91, 116	0
1	C	195/205 (95%)	0.63	9 (4%) 37 29	22, 43, 79, 114	0
1	D	191/205 (93%)	1.35	39 (20%) 3 2	67, 93, 120, 139	0
2	H	221/231 (95%)	0.61	11 (4%) 34 27	15, 44, 92, 123	0
2	M	229/231 (99%)	0.43	7 (3%) 51 41	25, 45, 79, 113	0
2	O	224/231 (96%)	0.94	27 (12%) 8 7	40, 80, 107, 145	0
2	Q	212/231 (91%)	1.59	64 (30%) 1 1	76, 103, 127, 154	0
3	L	210/214 (98%)	0.58	16 (7%) 20 16	16, 51, 100, 137	0
3	N	209/214 (97%)	0.54	10 (4%) 35 28	26, 45, 75, 90	0
3	P	208/214 (97%)	1.28	29 (13%) 6 5	49, 98, 126, 161	0
3	S	204/214 (95%)	1.50	51 (25%) 2 1	64, 98, 127, 148	0
All	All	2493/2600 (95%)	0.88	288 (11%) 9 8	15, 66, 117, 161	0

The worst 5 of 288 RSRZ outliers are listed below:

Mol	Chain	Res	Type	RSRZ
2	Q	100(J)	GLY	5.2
2	O	53	SER	4.9
1	D	387	LEU	4.5
2	Q	18	LEU	4.5
3	S	5	THR	4.4

6.2 Non-standard residues in protein, DNA, RNA chains [i](#)

There are no non-standard protein/DNA/RNA residues in this entry.

6.3 Carbohydrates [i](#)

There are no oligosaccharides in this entry.

6.4 Ligands [i](#)

In the following table, the Atoms column lists the number of modelled atoms in the group and the number defined in the chemical component dictionary. The B-factors column lists the minimum, median, 95th percentile and maximum values of B factors of atoms in the group. The column labelled 'Q< 0.9' lists the number of atoms with occupancy less than 0.9.

Mol	Type	Chain	Res	Atoms	RSCC	RSR	B-factors(Å ²)	Q<0.9
4	NAG	D	600	14/15	0.73	0.11	84,90,94,95	0
4	NAG	A	600	14/15	0.80	0.12	36,41,49,50	0

6.5 Other polymers [i](#)

There are no such residues in this entry.