



wwPDB X-ray Structure Validation Summary Report ⓘ

Mar 10, 2026 – 12:27 AM UTC

PDB ID : 8VVM / pdb_00008vvm
Title : Structure of FabS1CE1-EPR1-1 in complex with the erythropoietin receptor
Authors : Singer, A.U.; Bruce, H.A.; Pavlenco, A.; Ploder, L.; Luu, G.; Blazer, L.;
Adams, J.J.; Sidhu, S.S.
Deposited on : 2024-01-31
Resolution : 2.90 Å(reported)

This is a wwPDB X-ray Structure Validation Summary Report for a publicly released PDB entry.

We welcome your comments at validation@mail.wwpdb.org

A user guide is available at

<https://www.wwpdb.org/validation/2017/XrayValidationReportHelp>

with specific help available everywhere you see the ⓘ symbol.

The types of validation reports are described at

<http://www.wwpdb.org/validation/2017/FAQs#types>.

The following versions of software and data (see [references ⓘ](#)) were used in the production of this report:

MolProbity : 4-5-2 with Phenix2.0
Mogul : 2022.3.0, CSD as543be (2022)
Xtriage (Phenix) : 2.0
EDS : 3.0
Percentile statistics : 20250101.v01 (using entries in the PDB archive January 1st 2025)
CCP4 : 9.0.010 (Gargrove)
Density-Fitness : 1.0.12
Ideal geometry (proteins) : Engh & Huber (2001)
Ideal geometry (DNA, RNA) : Parkinson et al. (1996)
Validation Pipeline (wwPDB-VP) : 2.49

1 Overall quality at a glance

The following experimental techniques were used to determine the structure:

X-RAY DIFFRACTION

The reported resolution of this entry is 2.90 Å.

Percentile scores (ranging between 0-100) for global validation metrics of the entry are shown in the following graphic. The table shows the number of entries on which the scores are based.

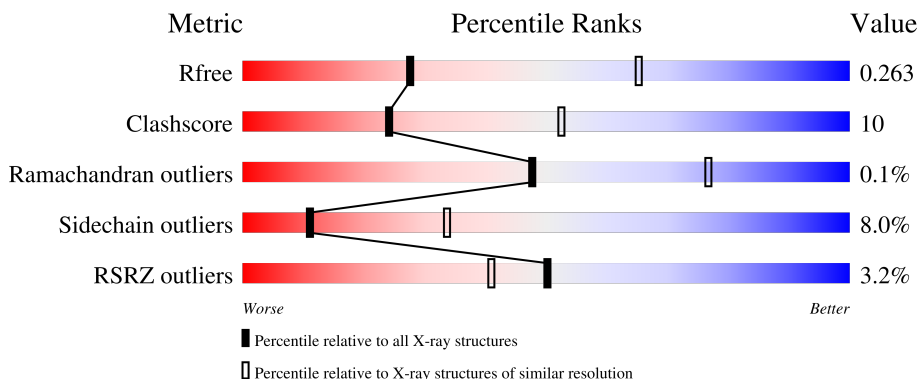

Metric	Whole archive (#Entries)	Similar resolution (#Entries, resolution range(Å))
R_{free}	180053	2481 (2.90-2.90)
Clashscore	190562	2690 (2.90-2.90)
Ramachandran outliers	187476	2623 (2.90-2.90)
Sidechain outliers	187428	2625 (2.90-2.90)
RSRZ outliers	180081	2481 (2.90-2.90)

The table below summarises the geometric issues observed across the polymeric chains and their fit to the electron density. The red, orange, yellow and green segments of the lower bar indicate the fraction of residues that contain outliers for ≥ 3 , 2, 1 and 0 types of geometric quality criteria respectively. A grey segment represents the fraction of residues that are not modelled. The numeric value for each fraction is indicated below the corresponding segment, with a dot representing fractions $\leq 5\%$. The upper red bar (where present) indicates the fraction of residues that have poor fit to the electron density. The numeric value is given above the bar.

Mol	Chain	Length	Quality of chain
1	A	224	 2% 77% 21%
1	B	224	 3% 75% 17% 7%
2	C	212	 2% 75% 21%
2	G	212	 0% 76% 22%
3	I	232	 6% 54% 30% 13%

The following table lists non-polymeric compounds, carbohydrate monomers and non-standard residues in protein, DNA, RNA chains that are outliers for geometric or electron-density-fit criteria:

Mol	Type	Chain	Res	Chirality	Geometry	Clashes	Electron density
6	CL	C	304	-	-	X	-

2 Entry composition

There are 8 unique types of molecules in this entry. The entry contains 7951 atoms, of which 0 are hydrogens and 0 are deuteriums.

In the tables below, the ZeroOcc column contains the number of atoms modelled with zero occupancy, the AltConf column contains the number of residues with at least one atom in alternate conformation and the Trace column contains the number of residues modelled with at most 2 atoms.

- Molecule 1 is a protein called S1CE1 VARIANT OF FAB-EPR-1 heavy chain.

Mol	Chain	Residues	Atoms					ZeroOcc	AltConf	Trace
			Total	C	N	O	S			
1	A	219	Total 1633	C 1037	N 270	O 318	S 8	0	0	0
1	B	209	Total 1540	C 983	N 252	O 298	S 7	0	0	0

- Molecule 2 is a protein called S1CE1 VARIANT OF FAB-EPR-1 light chain.

Mol	Chain	Residues	Atoms					ZeroOcc	AltConf	Trace
			Total	C	N	O	S			
2	G	212	Total 1602	C 999	N 264	O 333	S 6	0	0	0
2	C	210	Total 1599	C 998	N 264	O 331	S 6	0	1	0

- Molecule 3 is a protein called Erythropoietin receptor.

Mol	Chain	Residues	Atoms					ZeroOcc	AltConf	Trace
			Total	C	N	O	S			
3	I	202	Total 1531	C 977	N 265	O 282	S 7	0	0	0

There are 6 discrepancies between the modelled and reference sequences:

Chain	Residue	Modelled	Actual	Comment	Reference
I	227	HIS	-	expression tag	UNP P19235
I	228	HIS	-	expression tag	UNP P19235
I	229	HIS	-	expression tag	UNP P19235
I	230	HIS	-	expression tag	UNP P19235
I	231	HIS	-	expression tag	UNP P19235
I	232	HIS	-	expression tag	UNP P19235

- Molecule 4 is DI(HYDROXYETHYL)ETHER (CCD ID: PEG) (formula: C₄H₁₀O₃).



Mol	Chain	Residues	Atoms	ZeroOcc	AltConf
4	A	1	Total C O 7 4 3	0	0
4	G	1	Total C O 7 4 3	0	0
4	B	1	Total C O 7 4 3	0	0
4	C	1	Total C O 7 4 3	0	0

- Molecule 5 is SODIUM ION (CCD ID: NA) (formula: Na).

Mol	Chain	Residues	Atoms	ZeroOcc	AltConf
5	A	2	Total Na 2 2	0	0
5	B	1	Total Na 1 1	0	0
5	C	1	Total Na 1 1	0	0

- Molecule 6 is CHLORIDE ION (CCD ID: CL) (formula: Cl).

Mol	Chain	Residues	Atoms	ZeroOcc	AltConf
6	A	1	Total Cl 1 1	0	0
6	G	1	Total Cl 1 1	0	0

Continued on next page...

Continued from previous page...

Mol	Chain	Residues	Atoms	ZeroOcc	AltConf
6	B	1	Total Cl 1 1	0	0
6	C	4	Total Cl 4 4	0	0

- Molecule 7 is 1,2-ETHANEDIOL (CCD ID: EDO) (formula: C₂H₆O₂).

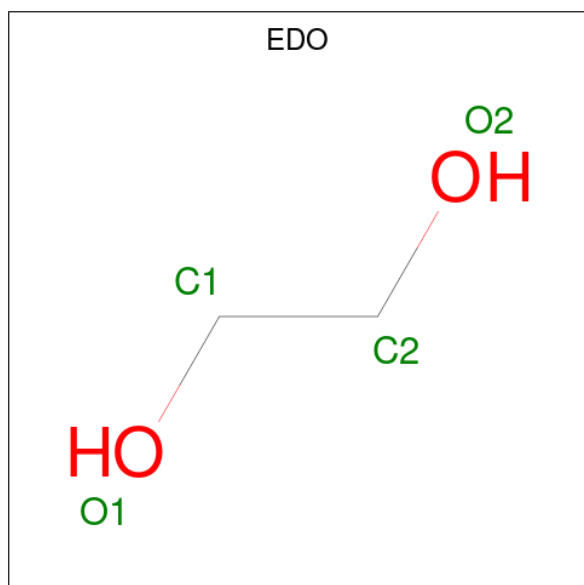

Mol	Chain	Residues	Atoms	ZeroOcc	AltConf
7	C	1	Total C O 4 2 2	0	0

- Molecule 8 is water.

Mol	Chain	Residues	Atoms	ZeroOcc	AltConf
8	B	2	Total O 2 2	0	0
8	C	1	Total O 1 1	0	0

3 Residue-property plots [i](#)

These plots are drawn for all protein, RNA, DNA and oligosaccharide chains in the entry. The first graphic for a chain summarises the proportions of the various outlier classes displayed in the second graphic. The second graphic shows the sequence view annotated by issues in geometry and electron density. Residues are color-coded according to the number of geometric quality criteria for which they contain at least one outlier: green = 0, yellow = 1, orange = 2 and red = 3 or more. A red dot above a residue indicates a poor fit to the electron density ($RSRZ > 2$). Stretches of 2 or more consecutive residues without any outlier are shown as a green connector. Residues present in the sample, but not in the model, are shown in grey.

- Molecule 1: S1CE1 VARIANT OF FAB-EPR-1 heavy chain

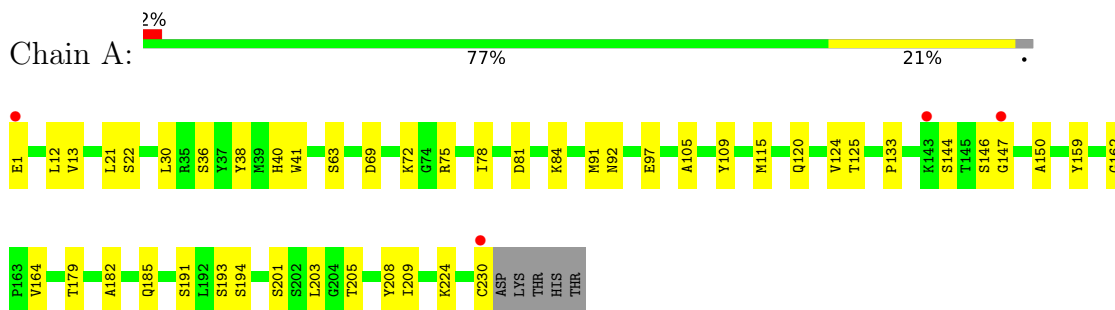

- Molecule 1: S1CE1 VARIANT OF FAB-EPR-1 heavy chain

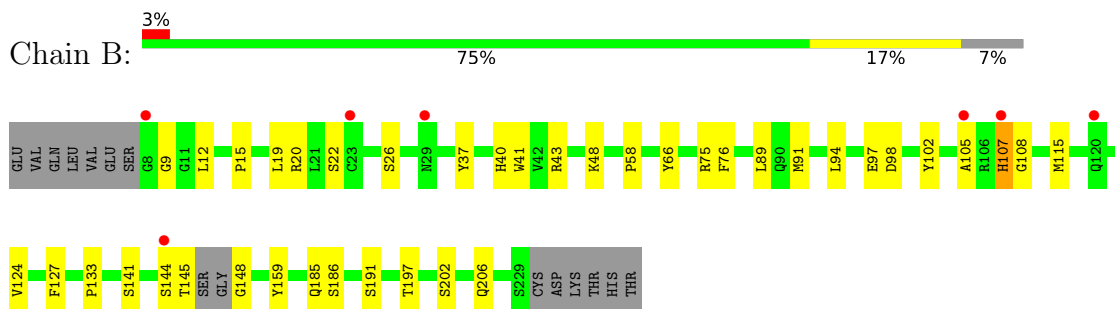

- Molecule 2: S1CE1 VARIANT OF FAB-EPR-1 light chain

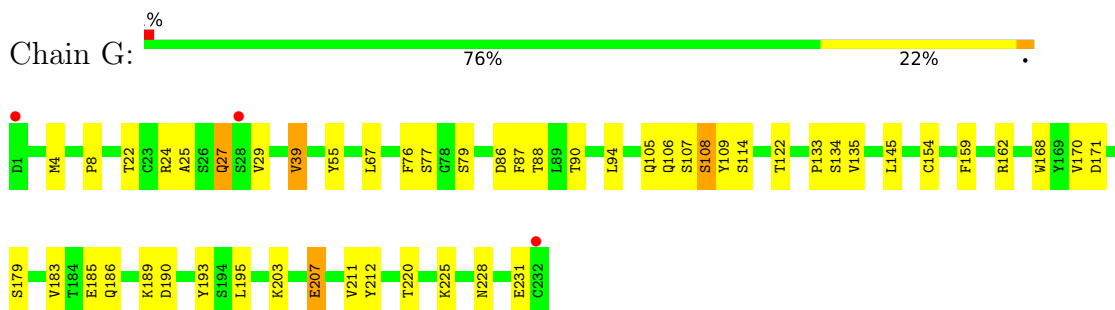

- Molecule 2: S1CE1 VARIANT OF FAB-EPR-1 light chain

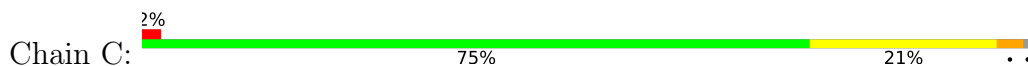

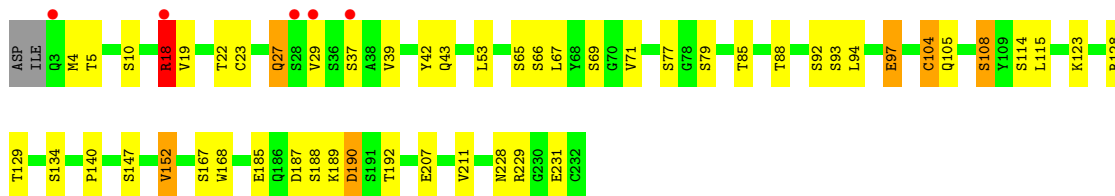

● Molecule 3: Erythropoietin receptor

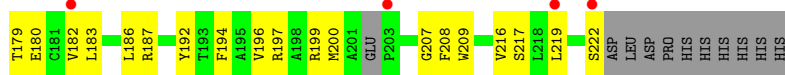
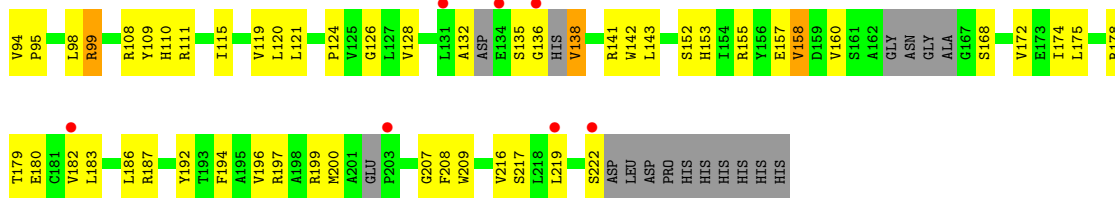
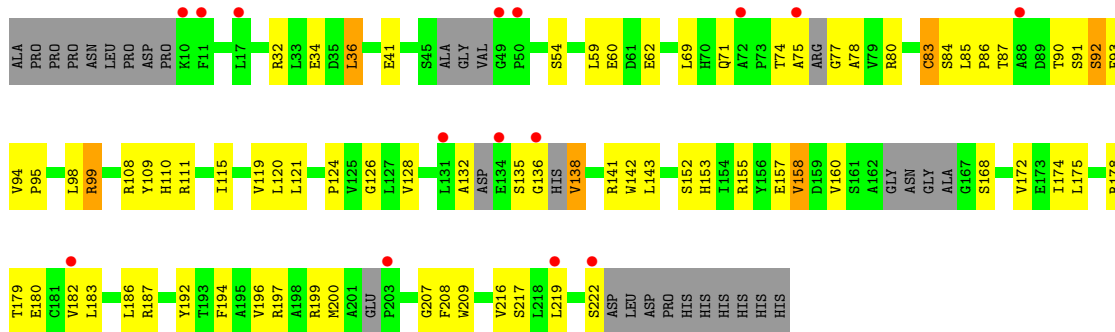

4 Data and refinement statistics

Property	Value	Source
Space group	P 21 21 21	Depositor
Cell constants a, b, c, α , β , γ	73.17Å 91.61Å 216.74Å 90.00° 90.00° 90.00°	Depositor
Resolution (Å)	84.38 – 2.90 84.38 – 2.90	Depositor EDS
% Data completeness (in resolution range)	99.8 (84.38-2.90) 99.8 (84.38-2.90)	Depositor EDS
R_{merge}	0.12	Depositor
R_{sym}	(Not available)	Depositor
$\langle I/\sigma(I) \rangle$ ¹	1.99 (at 2.91Å)	Xtrriage
Refinement program	PHENIX 1.20.1_4487	Depositor
R, R_{free}	0.219 , 0.273 (Not available) , 0.263	Depositor DCC
R_{free} test set	2235 reflections (4.81%)	wwPDB-VP
Wilson B-factor (Å ²)	79.1	Xtrriage
Anisotropy	0.415	Xtrriage
Bulk solvent k_{sol} (e/Å ³), B_{sol} (Å ²)	0.32 , 52.3	EDS
L-test for twinning ²	$\langle L \rangle = 0.51$, $\langle L^2 \rangle = 0.34$	Xtrriage
Estimated twinning fraction	No twinning to report.	Xtrriage
F_o, F_c correlation	0.94	EDS
Total number of atoms	7951	wwPDB-VP
Average B, all atoms (Å ²)	79.0	wwPDB-VP

Xtrriage's analysis on translational NCS is as follows: *The largest off-origin peak in the Patterson function is 4.71% of the height of the origin peak. No significant pseudotranslation is detected.*

¹Intensities estimated from amplitudes.

²Theoretical values of $\langle |L| \rangle$, $\langle L^2 \rangle$ for acentric reflections are 0.5, 0.333 respectively for untwinned datasets, and 0.375, 0.2 for perfectly twinned datasets.

5 Model quality i

5.1 Standard geometry i

Bond lengths and bond angles in the following residue types are not validated in this section: PEG, NA, CL, EDO

The Z score for a bond length (or angle) is the number of standard deviations the observed value is removed from the expected value. A bond length (or angle) with $|Z| > 5$ is considered an outlier worth inspection. RMSZ is the root-mean-square of all Z scores of the bond lengths (or angles).

Mol	Chain	Bond lengths		Bond angles	
		RMSZ	# Z >5	RMSZ	# Z >5
1	A	0.44	0/1677	0.68	0/2290
1	B	0.51	1/1583 (0.1%)	0.71	1/2165 (0.0%)
2	C	0.51	0/1631	0.79	3/2216 (0.1%)
2	G	0.46	0/1634	0.75	2/2221 (0.1%)
3	I	0.35	0/1568	0.57	0/2138
All	All	0.46	1/8093 (0.0%)	0.71	6/11030 (0.1%)

Chiral center outliers are detected by calculating the chiral volume of a chiral center and verifying if the center is modelled as a planar moiety or with the opposite hand. A planarity outlier is detected by checking planarity of atoms in a peptide group, atoms in a mainchain group or atoms of a sidechain that are expected to be planar.

Mol	Chain	#Chirality outliers	#Planarity outliers
2	C	0	3

All (1) bond length outliers are listed below:

Mol	Chain	Res	Type	Atoms	Z	Observed(Å)	Ideal(Å)
1	B	206	GLN	CD-NE2	5.51	1.44	1.33

The worst 5 of 6 bond angle outliers are listed below:

Mol	Chain	Res	Type	Atoms	Z	Observed(°)	Ideal(°)
2	G	27	GLN	CA-C-N	7.24	135.37	121.54
2	G	27	GLN	C-N-CA	7.24	135.37	121.54
2	C	27	GLN	CA-CB-CG	5.68	125.46	114.10
1	B	206	GLN	CA-CB-CG	5.43	124.96	114.10
2	C	18[A]	ARG	N-CA-C	-5.01	101.54	109.96

There are no chirality outliers.

All (3) planarity outliers are listed below:

Mol	Chain	Res	Type	Group
2	C	18[A]	ARG	Mainchain,Sidechain
2	C	27	GLN	Peptide

5.2 Too-close contacts [i](#)

In the following table, the Non-H and H(model) columns list the number of non-hydrogen atoms and hydrogen atoms in the chain respectively. The H(added) column lists the number of hydrogen atoms added and optimized by MolProbity. The Clashes column lists the number of clashes within the asymmetric unit, whereas Symm-Clashes lists symmetry-related clashes.

Mol	Chain	Non-H	H(model)	H(added)	Clashes	Symm-Clashes
1	A	1633	0	1565	29	0
1	B	1540	0	1455	22	0
2	C	1599	0	1533	28	0
2	G	1602	0	1535	30	0
3	I	1531	0	1457	53	0
4	A	7	0	10	2	0
4	B	7	0	10	3	0
4	C	7	0	10	0	0
4	G	7	0	10	1	0
5	A	2	0	0	0	0
5	B	1	0	0	0	0
5	C	1	0	0	0	0
6	A	1	0	0	0	0
6	B	1	0	0	0	0
6	C	4	0	0	2	0
6	G	1	0	0	0	0
7	C	4	0	6	0	0
8	B	2	0	0	0	0
8	C	1	0	0	0	0
All	All	7951	0	7591	156	0

The all-atom clashscore is defined as the number of clashes found per 1000 atoms (including hydrogen atoms). The all-atom clashscore for this structure is 10.

The worst 5 of 156 close contacts within the same asymmetric unit are listed below, sorted by their clash magnitude.

Atom-1	Atom-2	Interatomic distance (Å)	Clash overlap (Å)
1:A:182:ALA:HB2	4:A:301:PEG:H22	1.68	0.74

Continued on next page...

Continued from previous page...

Atom-1	Atom-2	Interatomic distance (Å)	Clash overlap (Å)
2:G:4:MET:HE2	2:G:106:GLN:HB2	1.68	0.74
2:C:4:MET:HE1	2:C:23:CYS:SG	2.29	0.72
1:A:21:LEU:HG	1:A:91:MET:HE2	1.71	0.70
1:A:69:ASP:HA	1:A:72:LYS:HD2	1.73	0.70

There are no symmetry-related clashes.

5.3 Torsion angles [i](#)

5.3.1 Protein backbone [i](#)

In the following table, the Percentiles column shows the percent Ramachandran outliers of the chain as a percentile score with respect to all X-ray entries followed by that with respect to entries of similar resolution.

The Analysed column shows the number of residues for which the backbone conformation was analysed, and the total number of residues.

Mol	Chain	Analysed	Favoured	Allowed	Outliers	Percentiles	
1	A	217/224 (97%)	212 (98%)	5 (2%)	0	100	100
1	B	205/224 (92%)	200 (98%)	4 (2%)	1 (0%)	24	54
2	C	209/212 (99%)	197 (94%)	12 (6%)	0	100	100
2	G	210/212 (99%)	197 (94%)	13 (6%)	0	100	100
3	I	188/232 (81%)	170 (90%)	18 (10%)	0	100	100
All	All	1029/1104 (93%)	976 (95%)	52 (5%)	1 (0%)	48	77

All (1) Ramachandran outliers are listed below:

Mol	Chain	Res	Type
1	B	107	HIS

5.3.2 Protein sidechains [i](#)

In the following table, the Percentiles column shows the percent sidechain outliers of the chain as a percentile score with respect to all X-ray entries followed by that with respect to entries of similar resolution.

The Analysed column shows the number of residues for which the sidechain conformation was analysed, and the total number of residues.

Mol	Chain	Analysed	Rotameric	Outliers	Percentiles	
1	A	177/186 (95%)	167 (94%)	10 (6%)	19	50
1	B	163/186 (88%)	155 (95%)	8 (5%)	22	54
2	C	181/187 (97%)	161 (89%)	20 (11%)	6	20
2	G	182/187 (97%)	168 (92%)	14 (8%)	12	35
3	I	158/193 (82%)	140 (89%)	18 (11%)	5	18
All	All	861/939 (92%)	791 (92%)	70 (8%)	11	33

5 of 70 residues with a non-rotameric sidechain are listed below:

Mol	Chain	Res	Type
3	I	92	SER
3	I	99	ARG
3	I	182	VAL
1	B	22	SER
2	G	220	THR

Sometimes sidechains can be flipped to improve hydrogen bonding and reduce clashes. 5 of 8 such sidechains are listed below:

Mol	Chain	Res	Type
3	I	116	ASN
2	C	180	GLN
2	G	44	GLN
1	A	107	HIS
2	G	218	GLN

5.3.3 RNA [i](#)

There are no RNA molecules in this entry.

5.4 Non-standard residues in protein, DNA, RNA chains [i](#)

There are no non-standard protein/DNA/RNA residues in this entry.

5.5 Carbohydrates [i](#)

There are no oligosaccharides in this entry.

5.6 Ligand geometry

Of 16 ligands modelled in this entry, 11 are monoatomic - leaving 5 for Mogul analysis.

In the following table, the Counts columns list the number of bonds (or angles) for which Mogul statistics could be retrieved, the number of bonds (or angles) that are observed in the model and the number of bonds (or angles) that are defined in the Chemical Component Dictionary. The Link column lists molecule types, if any, to which the group is linked. The Z score for a bond length (or angle) is the number of standard deviations the observed value is removed from the expected value. A bond length (or angle) with $|Z| > 2$ is considered an outlier worth inspection. RMSZ is the root-mean-square of all Z scores of the bond lengths (or angles).

Mol	Type	Chain	Res	Link	Bond lengths			Bond angles		
					Counts	RMSZ	# Z > 2	Counts	RMSZ	# Z > 2
4	PEG	A	301	-	6,6,6	0.50	0	5,5,5	0.32	0
4	PEG	G	301	-	6,6,6	0.33	0	5,5,5	0.29	0
7	EDO	C	301	-	3,3,3	0.68	0	2,2,2	0.15	0
4	PEG	B	301	-	6,6,6	0.37	0	5,5,5	0.18	0
4	PEG	C	302	-	6,6,6	0.39	0	5,5,5	0.41	0

In the following table, the Chirals column lists the number of chiral outliers, the number of chiral centers analysed, the number of these observed in the model and the number defined in the Chemical Component Dictionary. Similar counts are reported in the Torsion and Rings columns. '2' means no outliers of that kind were identified.

Mol	Type	Chain	Res	Link	Chirals	Torsions	Rings
4	PEG	A	301	-	-	1/4/4/4	-
4	PEG	G	301	-	-	1/4/4/4	-
7	EDO	C	301	-	-	1/1/1/1	-
4	PEG	B	301	-	-	2/4/4/4	-
4	PEG	C	302	-	-	3/4/4/4	-

There are no bond length outliers.

There are no bond angle outliers.

There are no chirality outliers.

5 of 8 torsion outliers are listed below:

Mol	Chain	Res	Type	Atoms
4	C	302	PEG	C1-C2-O2-C3
4	C	302	PEG	O2-C3-C4-O4
4	G	301	PEG	O1-C1-C2-O2
4	C	302	PEG	O1-C1-C2-O2
4	B	301	PEG	O2-C3-C4-O4

There are no ring outliers.

3 monomers are involved in 6 short contacts:

Mol	Chain	Res	Type	Clashes	Symm-Clashes
4	A	301	PEG	2	0
4	G	301	PEG	1	0
4	B	301	PEG	3	0

5.7 Other polymers [i](#)

There are no such residues in this entry.

5.8 Polymer linkage issues [i](#)

There are no chain breaks in this entry.

6 Fit of model and data [i](#)

6.1 Protein, DNA and RNA chains [i](#)

In the following table, the column labelled ‘#RSRZ > 2’ contains the number (and percentage) of RSRZ outliers, followed by percent RSRZ outliers for the chain as percentile scores relative to all X-ray entries and entries of similar resolution. The OWAB column contains the minimum, median, 95th percentile and maximum values of the occupancy-weighted average B-factor per residue. The column labelled ‘Q < 0.9’ lists the number of (and percentage) of residues with an average occupancy less than 0.9.

Mol	Chain	Analysed	<RSRZ>	#RSRZ>2	OWAB(Å ²)	Q<0.9
1	A	219/224 (97%)	0.06	4 (1%) 67 59	57, 68, 89, 125	0
1	B	209/224 (93%)	0.29	7 (3%) 49 40	51, 81, 110, 126	0
2	C	210/212 (99%)	0.10	5 (2%) 59 50	42, 71, 106, 125	1 (0%)
2	G	212/212 (100%)	0.13	3 (1%) 73 65	56, 70, 98, 124	0
3	I	202/232 (87%)	0.77	15 (7%) 20 17	78, 104, 126, 140	0
All	All	1052/1104 (95%)	0.27	34 (3%) 50 41	42, 76, 116, 140	1 (0%)

The worst 5 of 34 RSRZ outliers are listed below:

Mol	Chain	Res	Type	RSRZ
2	C	29	VAL	3.6
3	I	136	GLY	3.5
3	I	75	ALA	3.4
2	C	37	SER	3.4
3	I	219	LEU	3.3

6.2 Non-standard residues in protein, DNA, RNA chains [i](#)

There are no non-standard protein/DNA/RNA residues in this entry.

6.3 Carbohydrates [i](#)

There are no oligosaccharides in this entry.

6.4 Ligands [i](#)

In the following table, the Atoms column lists the number of modelled atoms in the group and the number defined in the chemical component dictionary. The B-factors column lists the minimum,

median, 95th percentile and maximum values of B factors of atoms in the group. The column labelled 'Q< 0.9' lists the number of atoms with occupancy less than 0.9.

Mol	Type	Chain	Res	Atoms	RSCC	RSR	B-factors(Å ²)	Q<0.9
4	PEG	A	301	7/7	0.71	0.23	71,71,71,71	0
4	PEG	C	302	7/7	0.72	0.19	73,73,73,73	0
7	EDO	C	301	4/4	0.81	0.16	70,70,70,70	0
4	PEG	B	301	7/7	0.82	0.14	75,75,75,75	0
5	NA	A	302	1/1	0.84	0.28	72,72,72,72	0
6	CL	A	304	1/1	0.86	0.11	76,76,76,76	0
6	CL	C	306	1/1	0.89	0.12	77,77,77,77	0
4	PEG	G	301	7/7	0.90	0.14	63,63,63,63	0
6	CL	C	305	1/1	0.90	0.11	95,95,95,95	0
5	NA	B	302	1/1	0.91	0.20	49,49,49,49	0
5	NA	A	303	1/1	0.92	0.27	68,68,68,68	0
6	CL	C	307	1/1	0.92	0.08	77,77,77,77	0
5	NA	C	303	1/1	0.92	0.28	64,64,64,64	0
6	CL	B	303	1/1	0.93	0.16	94,94,94,94	0
6	CL	C	304	1/1	0.93	0.19	70,70,70,70	0
6	CL	G	302	1/1	0.96	0.09	80,80,80,80	0

6.5 Other polymers [i](#)

There are no such residues in this entry.