



wwPDB X-ray Structure Validation Summary Report ⓘ

Mar 5, 2026 – 09:54 AM UTC

PDB ID : 3WSV / pdb_00003wsv
Title : Crystal structure of minor L-lactate dehydrogenase from *Enterococcus mundtii* in the ligands-unbound form
Authors : Matoba, Y.; Sugiyama, M.
Deposited on : 2014-03-27
Resolution : 2.38 Å (reported)

This is a wwPDB X-ray Structure Validation Summary Report for a publicly released PDB entry.

We welcome your comments at validation@mail.wwpdb.org

A user guide is available at

<https://www.wwpdb.org/validation/2017/XrayValidationReportHelp>

with specific help available everywhere you see the ⓘ symbol.

The types of validation reports are described at

<http://www.wwpdb.org/validation/2017/FAQs#types>.

The following versions of software and data (see [references ⓘ](#)) were used in the production of this report:

MolProbity : 4-5-2 with Phenix2.0
Mogul : 2022.3.0, CSD as543be (2022)
Xtriage (Phenix) : 2.0
EDS : 3.0
Percentile statistics : 20250101.v01 (using entries in the PDB archive January 1st 2025)
CCP4 : 9.0.010 (Gargrove)
Density-Fitness : 1.0.12
Ideal geometry (proteins) : Engh & Huber (2001)
Ideal geometry (DNA, RNA) : Parkinson et al. (1996)
Validation Pipeline (wwPDB-VP) : 2.49

1 Overall quality at a glance

The following experimental techniques were used to determine the structure:

X-RAY DIFFRACTION

The reported resolution of this entry is 2.38 Å.

Percentile scores (ranging between 0-100) for global validation metrics of the entry are shown in the following graphic. The table shows the number of entries on which the scores are based.

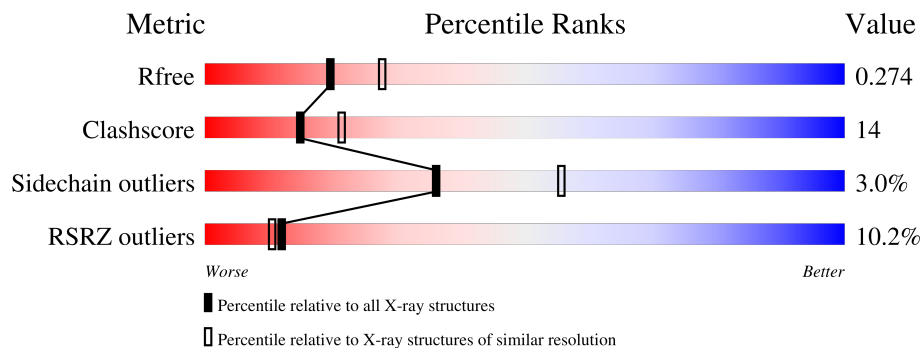

Metric	Whole archive (#Entries)	Similar resolution (#Entries, resolution range(Å))
R_{free}	180053	7164 (2.40-2.36)
Clashscore	190562	7722 (2.40-2.36)
Sidechain outliers	187428	7627 (2.40-2.36)
RSRZ outliers	180081	7170 (2.40-2.36)

The table below summarises the geometric issues observed across the polymeric chains and their fit to the electron density. The red, orange, yellow and green segments of the lower bar indicate the fraction of residues that contain outliers for ≥ 3 , 2, 1 and 0 types of geometric quality criteria respectively. A grey segment represents the fraction of residues that are not modelled. The numeric value for each fraction is indicated below the corresponding segment, with a dot representing fractions $\leq 5\%$. The upper red bar (where present) indicates the fraction of residues that have poor fit to the electron density. The numeric value is given above the bar.

Mol	Chain	Length	Quality of chain
1	A	322	
1	B	322	
1	C	322	
1	D	322	

2 Entry composition [i](#)

There are 3 unique types of molecules in this entry. The entry contains 10138 atoms, of which 0 are hydrogens and 0 are deuteriums.

In the tables below, the ZeroOcc column contains the number of atoms modelled with zero occupancy, the AltConf column contains the number of residues with at least one atom in alternate conformation and the Trace column contains the number of residues modelled with at most 2 atoms.

- Molecule 1 is a protein called L-lactate dehydrogenase.

Mol	Chain	Residues	Atoms					ZeroOcc	AltConf	Trace
			Total	C	N	O	S			
1	A	312	Total 2400	C 1513	N 407	O 472	S 8	0	0	0
1	B	317	Total 2441	C 1538	N 415	O 481	S 7	0	0	0
1	C	312	Total 2400	C 1513	N 407	O 472	S 8	0	0	0
1	D	317	Total 2441	C 1538	N 415	O 481	S 7	0	0	0

- Molecule 2 is GLYCEROL (CCD ID: GOL) (formula: C₃H₈O₃).

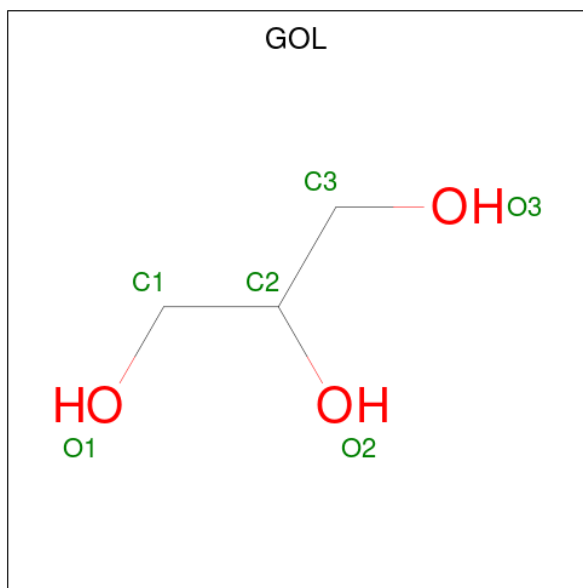

Mol	Chain	Residues	Atoms			ZeroOcc	AltConf
			Total	C	O		
2	A	1	Total 6	C 3	O 3	0	0
2	A	1	Total 6	C 3	O 3	0	0

Continued on next page...

Continued from previous page...

Mol	Chain	Residues	Atoms			ZeroOcc	AltConf
2	B	1	Total 6	C 3	O 3	0	0
2	B	1	Total 6	C 3	O 3	0	0
2	C	1	Total 6	C 3	O 3	0	0
2	C	1	Total 6	C 3	O 3	0	0
2	C	1	Total 6	C 3	O 3	0	0
2	D	1	Total 6	C 3	O 3	0	0

- Molecule 3 is water.

Mol	Chain	Residues	Atoms		ZeroOcc	AltConf
3	A	86	Total 86	O 86	0	0
3	B	121	Total 121	O 121	0	0
3	C	79	Total 79	O 79	0	0
3	D	122	Total 122	O 122	0	0

3 Residue-property plots [i](#)

These plots are drawn for all protein, RNA, DNA and oligosaccharide chains in the entry. The first graphic for a chain summarises the proportions of the various outlier classes displayed in the second graphic. The second graphic shows the sequence view annotated by issues in geometry and electron density. Residues are color-coded according to the number of geometric quality criteria for which they contain at least one outlier: green = 0, yellow = 1, orange = 2 and red = 3 or more. A red dot above a residue indicates a poor fit to the electron density ($RSRZ > 2$). Stretches of 2 or more consecutive residues without any outlier are shown as a green connector. Residues present in the sample, but not in the model, are shown in grey.

- Molecule 1: L-lactate dehydrogenase

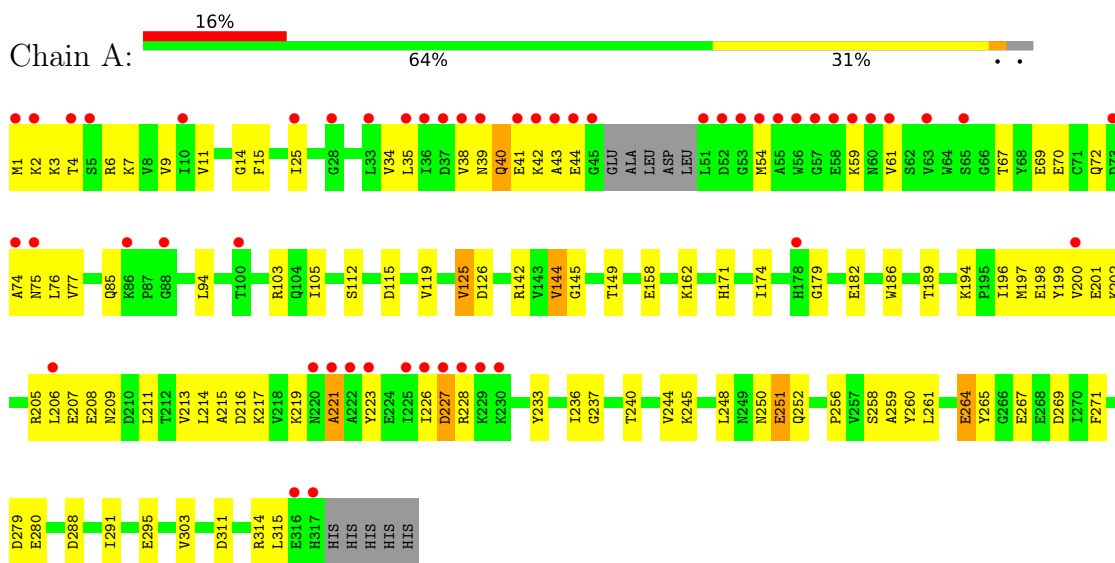

- Molecule 1: L-lactate dehydrogenase

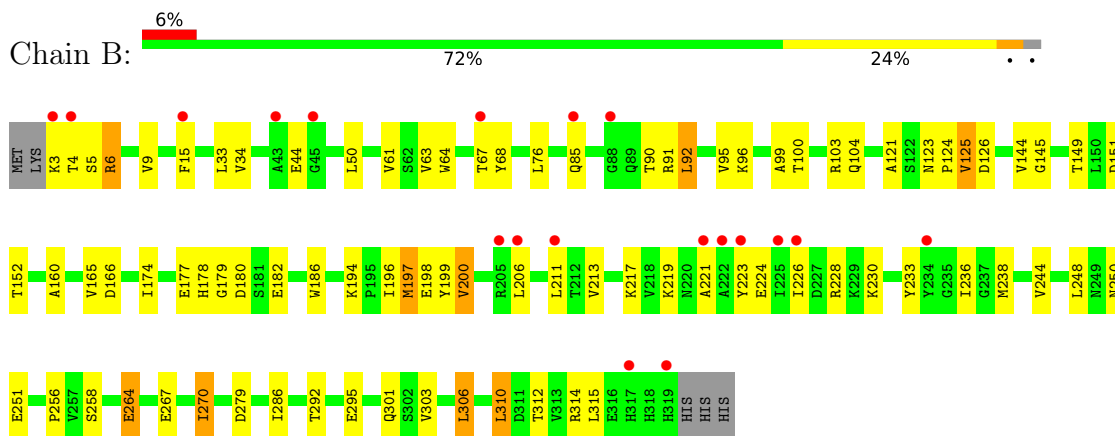

- Molecule 1: L-lactate dehydrogenase



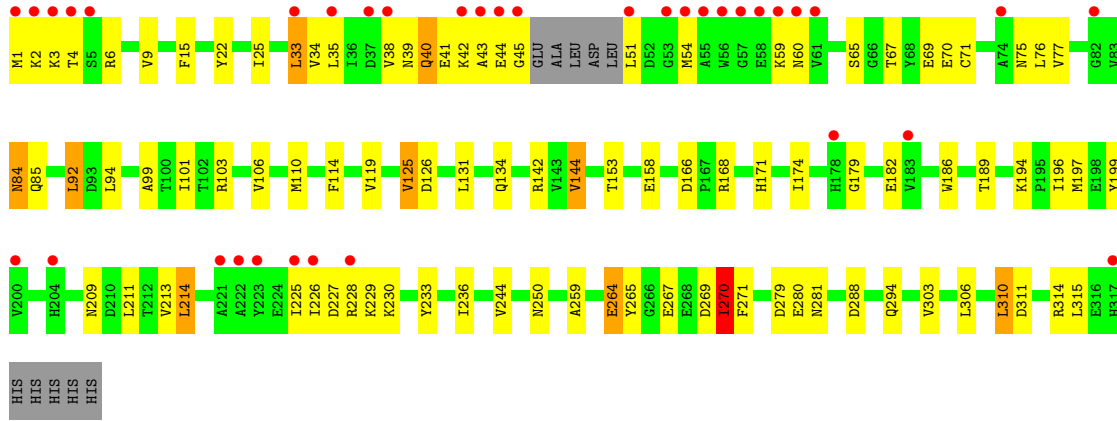

● Molecule 1: L-lactate dehydrogenase

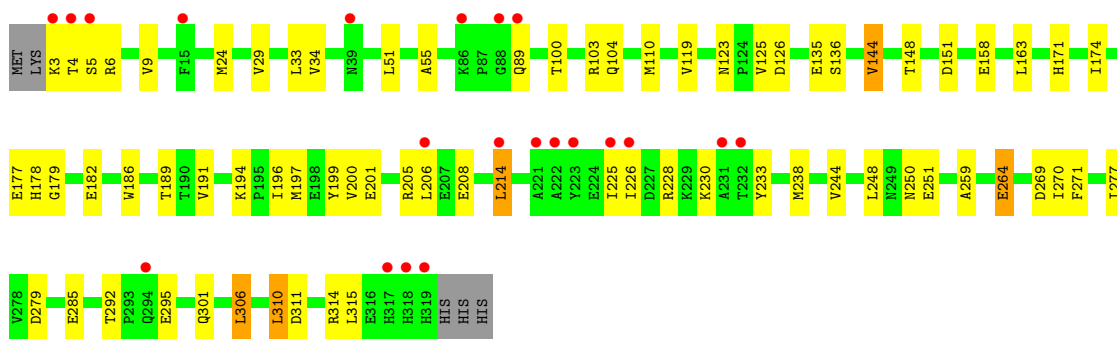
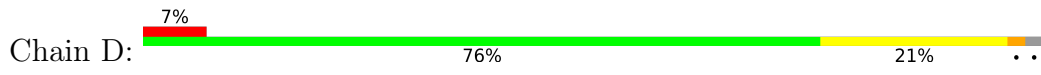

4 Data and refinement statistics

Property	Value	Source
Space group	P 21 21 21	Depositor
Cell constants a, b, c, α , β , γ	104.43Å 127.82Å 133.80Å 90.00° 90.00° 90.00°	Depositor
Resolution (Å)	29.96 – 2.38 29.96 – 2.38	Depositor EDS
% Data completeness (in resolution range)	96.4 (29.96-2.38) 99.4 (29.96-2.38)	Depositor EDS
R_{merge}	0.08	Depositor
R_{sym}	(Not available)	Depositor
$\langle I/\sigma(I) \rangle$ ¹	2.84 (at 2.39Å)	Xtrriage
Refinement program	CNS 1.2	Depositor
R, R_{free}	0.232 , 0.271 0.237 , 0.274	Depositor DCC
R_{free} test set	3632 reflections (5.04%)	wwPDB-VP
Wilson B-factor (Å ²)	45.7	Xtrriage
Anisotropy	0.639	Xtrriage
Bulk solvent k_{sol} (e/Å ³), B_{sol} (Å ²)	0.34 , 40.5	EDS
L-test for twinning ²	$\langle L \rangle = 0.57$, $\langle L^2 \rangle = 0.42$	Xtrriage
Estimated twinning fraction	0.000 for -h,l,k	Xtrriage
F_o, F_c correlation	0.96	EDS
Total number of atoms	10138	wwPDB-VP
Average B, all atoms (Å ²)	57.0	wwPDB-VP

Xtrriage's analysis on translational NCS is as follows: *The analyses of the Patterson function reveals a significant off-origin peak that is 54.76 % of the origin peak, indicating pseudo-translational symmetry. The chance of finding a peak of this or larger height randomly in a structure without pseudo-translational symmetry is equal to 3.4886e-05. The detected translational NCS is most likely also responsible for the elevated intensity ratio.*

¹Intensities estimated from amplitudes.

²Theoretical values of $\langle |L| \rangle$, $\langle L^2 \rangle$ for acentric reflections are 0.5, 0.333 respectively for untwinned datasets, and 0.375, 0.2 for perfectly twinned datasets.

5 Model quality [i](#)

5.1 Standard geometry [i](#)

Bond lengths and bond angles in the following residue types are not validated in this section: GOL

The Z score for a bond length (or angle) is the number of standard deviations the observed value is removed from the expected value. A bond length (or angle) with $|Z| > 5$ is considered an outlier worth inspection. RMSZ is the root-mean-square of all Z scores of the bond lengths (or angles).

Mol	Chain	Bond lengths		Bond angles	
		RMSZ	# Z >5	RMSZ	# Z >5
1	A	0.42	0/2436	0.89	7/3304 (0.2%)
1	B	0.44	0/2480	0.89	6/3368 (0.2%)
1	C	0.42	0/2436	0.87	5/3304 (0.2%)
1	D	0.43	0/2480	0.85	3/3368 (0.1%)
All	All	0.43	0/9832	0.87	21/13344 (0.2%)

There are no bond length outliers.

The worst 5 of 21 bond angle outliers are listed below:

Mol	Chain	Res	Type	Atoms	Z	Observed(°)	Ideal(°)
1	A	221	ALA	N-CA-C	-8.90	102.55	113.50
1	C	125	VAL	N-CA-C	8.68	118.75	110.42
1	C	174	ILE	N-CA-C	-7.87	97.16	108.17
1	B	125	VAL	N-CA-C	7.54	118.27	110.36
1	A	125	VAL	N-CA-C	7.36	118.09	110.36

There are no chirality outliers.

There are no planarity outliers.

5.2 Too-close contacts [i](#)

In the following table, the Non-H and H(model) columns list the number of non-hydrogen atoms and hydrogen atoms in the chain respectively. The H(added) column lists the number of hydrogen atoms added and optimized by MolProbity. The Clashes column lists the number of clashes within the asymmetric unit, whereas Symm-Clashes lists symmetry-related clashes.

Mol	Chain	Non-H	H(model)	H(added)	Clashes	Symm-Clashes
1	A	2400	0	2415	86	0
1	B	2441	0	2442	61	0

Continued on next page...

Continued from previous page...

Mol	Chain	Non-H	H(model)	H(added)	Clashes	Symm-Clashes
1	C	2400	0	2415	82	0
1	D	2441	0	2442	57	0
2	A	12	0	16	3	0
2	B	12	0	16	1	0
2	C	18	0	24	0	0
2	D	6	0	8	0	0
3	A	86	0	0	1	0
3	B	121	0	0	3	0
3	C	79	0	0	1	0
3	D	122	0	0	3	0
All	All	10138	0	9778	270	0

The all-atom clashscore is defined as the number of clashes found per 1000 atoms (including hydrogen atoms). The all-atom clashscore for this structure is 14.

The worst 5 of 270 close contacts within the same asymmetric unit are listed below, sorted by their clash magnitude.

Atom-1	Atom-2	Interatomic distance (Å)	Clash overlap (Å)
1:A:250:ASN:HB2	1:A:280:GLU:HG3	1.57	0.87
1:B:226:ILE:HD11	1:B:230:LYS:HD2	1.55	0.86
1:B:197:MET:HE3	1:B:197:MET:HA	1.57	0.85
1:C:158:GLU:HB3	1:C:214:LEU:HD11	1.57	0.85
1:A:35:LEU:HD11	1:A:54:MET:HE2	1.56	0.85

There are no symmetry-related clashes.

5.3 Torsion angles [i](#)

5.3.1 Protein backbone [i](#)

There are no protein backbone outliers to report in this entry.

5.3.2 Protein sidechains [i](#)

In the following table, the Percentiles column shows the percent sidechain outliers of the chain as a percentile score with respect to all X-ray entries followed by that with respect to entries of similar resolution.

The Analysed column shows the number of residues for which the sidechain conformation was analysed, and the total number of residues.

Mol	Chain	Analysed	Rotameric	Outliers	Percentiles
1	A	262/271 (97%)	257 (98%)	5 (2%)	50 69
1	B	266/271 (98%)	255 (96%)	11 (4%)	27 43
1	C	262/271 (97%)	253 (97%)	9 (3%)	32 51
1	D	266/271 (98%)	259 (97%)	7 (3%)	40 60
All	All	1056/1084 (97%)	1024 (97%)	32 (3%)	36 56

5 of 32 residues with a non-rotameric sidechain are listed below:

Mol	Chain	Res	Type
1	D	214	LEU
1	D	264	GLU
1	B	264	GLU
1	B	197	MET
1	D	306	LEU

Sometimes sidechains can be flipped to improve hydrogen bonding and reduce clashes. 5 of 18 such sidechains are listed below:

Mol	Chain	Res	Type
1	C	89	GLN
1	D	319	HIS
1	D	204	HIS
1	B	85	GLN
1	C	85	GLN

5.3.3 RNA [i](#)

There are no RNA molecules in this entry.

5.4 Non-standard residues in protein, DNA, RNA chains [i](#)

There are no non-standard protein/DNA/RNA residues in this entry.

5.5 Carbohydrates [i](#)

There are no oligosaccharides in this entry.

5.6 Ligand geometry

8 ligands are modelled in this entry.

In the following table, the Counts columns list the number of bonds (or angles) for which Mogul statistics could be retrieved, the number of bonds (or angles) that are observed in the model and the number of bonds (or angles) that are defined in the Chemical Component Dictionary. The Link column lists molecule types, if any, to which the group is linked. The Z score for a bond length (or angle) is the number of standard deviations the observed value is removed from the expected value. A bond length (or angle) with $|Z| > 2$ is considered an outlier worth inspection. RMSZ is the root-mean-square of all Z scores of the bond lengths (or angles).

Mol	Type	Chain	Res	Link	Bond lengths			Bond angles		
					Counts	RMSZ	# Z > 2	Counts	RMSZ	# Z > 2
2	GOL	D	401	-	5,5,5	0.40	0	5,5,5	0.32	0
2	GOL	C	503	-	5,5,5	0.45	0	5,5,5	0.28	0
2	GOL	A	402	-	5,5,5	0.37	0	5,5,5	0.24	0
2	GOL	B	402	-	5,5,5	0.42	0	5,5,5	0.27	0
2	GOL	B	401	-	5,5,5	0.45	0	5,5,5	0.24	0
2	GOL	A	401	-	5,5,5	0.33	0	5,5,5	0.29	0
2	GOL	C	502	-	5,5,5	0.34	0	5,5,5	0.29	0
2	GOL	C	501	-	5,5,5	0.38	0	5,5,5	0.25	0

In the following table, the Chirals column lists the number of chiral outliers, the number of chiral centers analysed, the number of these observed in the model and the number defined in the Chemical Component Dictionary. Similar counts are reported in the Torsion and Rings columns. '-' means no outliers of that kind were identified.

Mol	Type	Chain	Res	Link	Chirals	Torsions	Rings
2	GOL	D	401	-	-	4/4/4/4	-
2	GOL	C	503	-	-	2/4/4/4	-
2	GOL	A	402	-	-	0/4/4/4	-
2	GOL	B	402	-	-	2/4/4/4	-
2	GOL	B	401	-	-	2/4/4/4	-
2	GOL	A	401	-	-	4/4/4/4	-
2	GOL	C	502	-	-	4/4/4/4	-
2	GOL	C	501	-	-	2/4/4/4	-

There are no bond length outliers.

There are no bond angle outliers.

There are no chirality outliers.

5 of 20 torsion outliers are listed below:

Mol	Chain	Res	Type	Atoms
2	A	401	GOL	O1-C1-C2-O2
2	A	401	GOL	O1-C1-C2-C3
2	A	401	GOL	C1-C2-C3-O3
2	B	402	GOL	C1-C2-C3-O3
2	B	402	GOL	O2-C2-C3-O3

There are no ring outliers.

2 monomers are involved in 4 short contacts:

Mol	Chain	Res	Type	Clashes	Symm-Clashes
2	A	402	GOL	3	0
2	B	401	GOL	1	0

5.7 Other polymers [i](#)

There are no such residues in this entry.

5.8 Polymer linkage issues [i](#)

There are no chain breaks in this entry.

6 Fit of model and data [i](#)

6.1 Protein, DNA and RNA chains [i](#)

In the following table, the column labelled ‘#RSRZ > 2’ contains the number (and percentage) of RSRZ outliers, followed by percent RSRZ outliers for the chain as percentile scores relative to all X-ray entries and entries of similar resolution. The OWAB column contains the minimum, median, 95th percentile and maximum values of the occupancy-weighted average B-factor per residue. The column labelled ‘Q < 0.9’ lists the number of (and percentage) of residues with an average occupancy less than 0.9.

Mol	Chain	Analysed	<RSRZ>	#RSRZ>2	OWAB(Å ²)	Q<0.9
1	A	312/322 (96%)	0.80	52 (16%) 4 4	33, 53, 108, 121	0
1	B	317/322 (98%)	0.39	19 (5%) 27 26	32, 49, 82, 98	0
1	C	312/322 (96%)	0.70	36 (11%) 9 8	33, 53, 110, 132	0
1	D	317/322 (98%)	0.36	21 (6%) 24 23	32, 49, 86, 99	0
All	All	1258/1288 (97%)	0.56	128 (10%) 12 10	32, 51, 96, 132	0

The worst 5 of 128 RSRZ outliers are listed below:

Mol	Chain	Res	Type	RSRZ
1	C	43	ALA	8.6
1	C	55	ALA	8.1
1	A	51	LEU	6.9
1	A	225	ILE	6.4
1	C	225	ILE	6.3

6.2 Non-standard residues in protein, DNA, RNA chains [i](#)

There are no non-standard protein/DNA/RNA residues in this entry.

6.3 Carbohydrates [i](#)

There are no oligosaccharides in this entry.

6.4 Ligands [i](#)

In the following table, the Atoms column lists the number of modelled atoms in the group and the number defined in the chemical component dictionary. The B-factors column lists the minimum, median, 95th percentile and maximum values of B factors of atoms in the group. The column labelled ‘Q < 0.9’ lists the number of atoms with occupancy less than 0.9.

Mol	Type	Chain	Res	Atoms	RSCC	RSR	B-factors(\AA^2)	Q<0.9
2	GOL	C	501	6/6	0.71	0.19	90,92,92,92	0
2	GOL	C	502	6/6	0.71	0.14	95,98,98,99	0
2	GOL	A	401	6/6	0.72	0.11	91,93,93,94	0
2	GOL	C	503	6/6	0.74	0.16	80,81,82,82	0
2	GOL	B	402	6/6	0.76	0.21	86,87,88,88	0
2	GOL	B	401	6/6	0.86	0.17	57,62,63,64	0
2	GOL	D	401	6/6	0.90	0.13	56,60,62,62	0
2	GOL	A	402	6/6	0.91	0.11	74,77,77,77	0

6.5 Other polymers [i](#)

There are no such residues in this entry.